

# LIGHT POWER & PRECISION

## DRIVE DESIGN MANUAL



**POWERING PROGRESS™**

# Table of Contents

**NOTE:** Click on the desired item or page number to jump directly to that page.

<b>Introduction to Gates Products</b> .....	1 - 7
<b>Drive Comparison Graphs</b> .....	8
<b>Synchronous Drive Comparisons</b> .....	9 - 11
<b>PowerGrip® GT®3, HTD®, and Timing Belt Drive Selection Procedure - Single Sided</b> .....	12
<b>PowerGrip® GT®3 Belt Drives - Single Sided</b> .....	13 - 21
Belt Lengths and Widths .....	15 - 16
Pitch Selection Guide .....	17
Belt Width Selection / Torque and Power Ratings.....	18 - 21
<b>PowerGrip® GT®2 Belt Drives - Twin Power</b> .....	22 - 28
Belt Lengths and Widths .....	23
Drive Selection Procedure .....	24
Pitch Selection Guide .....	25
Belt Width Selection / Torque and Power Ratings.....	26 - 28
<b>5M PowerGrip® GT®2 Sprocket Information</b> .....	29 - 37
<b>PowerGrip® HTD® Belt Drives</b> .....	38 - 49
Belt Lengths and Widths - Single Sided .....	39 - 40
Pitch Selection Guide .....	41
Belt Width Selection / Torque Ratings - Single Sided & Twin Power.....	42 - 43
Twin Power Belt Drives.....	44
Belt Lengths and Widths - Twin Power.....	45
Sprocket Information.....	46 - 49
<b>PowerGrip® Timing Belt Drives</b> .....	50 - 58
Belt Lengths and Widths - Single Sided .....	51 - 52
Pitch Selection Guide .....	53
Belt Width Selection / Torque Ratings - Single Sided & Twin Power.....	54
Twin Power Belt Drives.....	55
Belt Lengths and Widths - Twin Power.....	56
Pulley Information.....	57 - 58
<b>PowerGrip® Long Length Belting</b> .....	59
<b>Synchronous Belt Drive Engineering</b> .....	60 - 79
Belt Tensioning.....	64 - 66
Synchronous Belt Specifications .....	72
Synchronous Sprocket Specifications.....	73 - 79
<b>Polyflex® JB® Belt Drives</b> .....	80 - 82
<b>Micro-V® Belt Drives</b> .....	83 - 84
<b>Polyflex® and Micro-V® Drive Selection Procedures</b> .....	85 - 90
Polyflex® JB® Power Ratings .....	88 - 89
Micro-V® Power Ratings .....	90
<b>Polyflex® and Micro-V® Belt Drive Engineering</b> .....	91 - 102
Belt Tensioning.....	93 - 94
Polyflex® Sheave Groove Specifications.....	98
Micro-V® Pulley Groove Specifications.....	99
Belt Pull and Bearing Loads .....	100 - 101
Belt Storage and Handling.....	102
<b>Useful Formulas and Calculations</b> .....	103 - 108



# Introduction

**Gates belt drive systems offer more advantages at lower cost than other methods of motion transfer or power transmission.**

**The popularity of Gates drive systems can be attributed to our commitment to customer satisfaction and quality.**

Gates continually makes strides in specialized research, product development, testing and overnight availability of products. The team of your design engineers and Gates application engineers assures an efficient, low-cost and quality drive system.

## **Total quality support**

Gates offers professional support from conceptual design to delivery of the finished product. We make sure you...

- use the best product for the application
- minimize drive package size and cost
- minimize testing time using our experience

## **Experienced technical support**

Our seasoned Application Engineering Group is waiting for you to tap their knowledge. They are armed with the latest in design software and are ready to make your ideas a reality.

Continuous engineering support is available for complex drive layouts including hardware design and specifications.

## **MADE-TO-ORDER METALS**

(800) 709-6001

## **CUSTOMER SERVICE**

(877) 782-3587

## **PRODUCT APPLICATION ENGINEERING**

(303) 744-5800

(303) 744-4600 fax

[ptpasupport@gates.com](mailto:ptpasupport@gates.com)

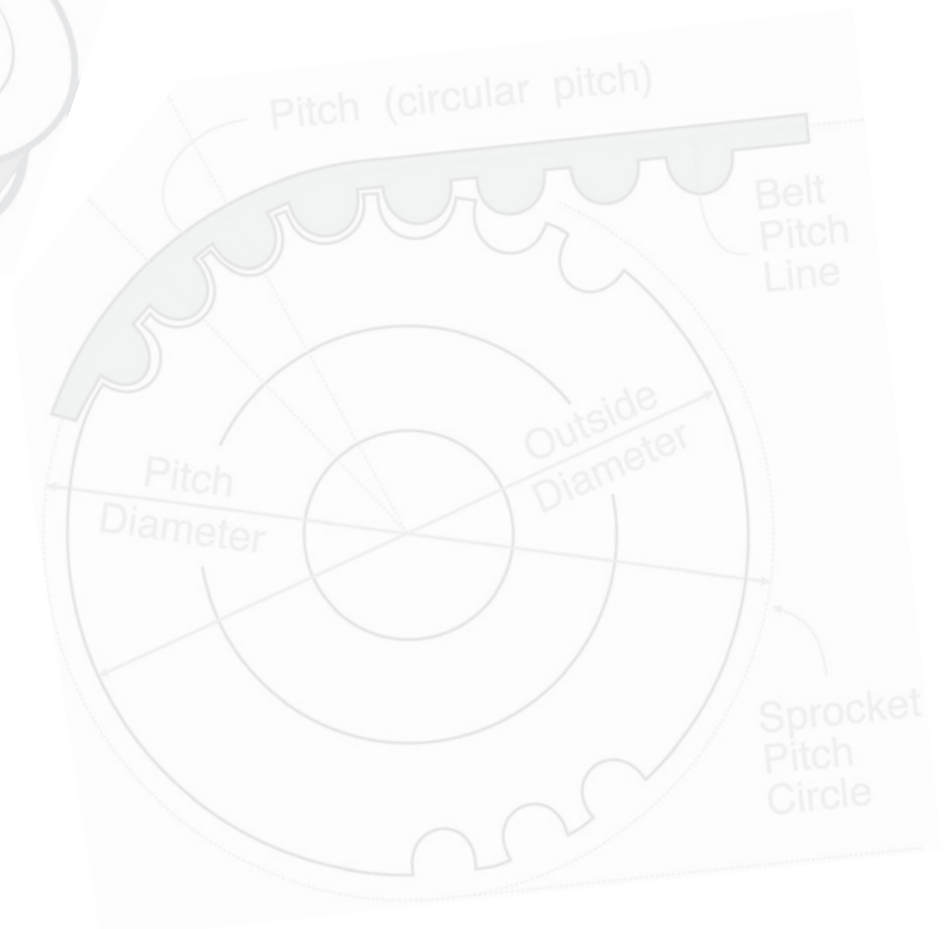

# Introduction – PowerGrip® GT®3 Belt Drives

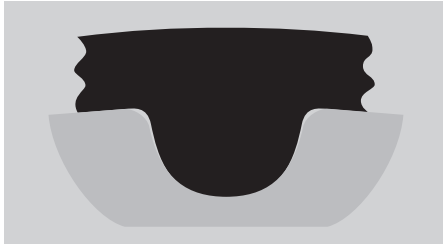

**PowerGrip® GT® 3 Belt  
Tooth/Groove Contact**

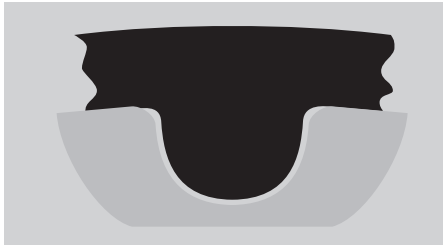

**PowerGrip® HTD® Belt  
Tooth/Groove Contact**

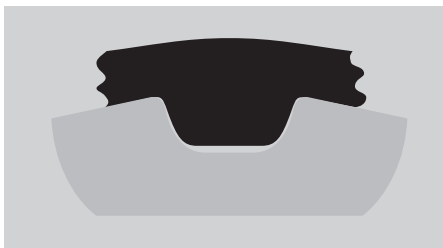

**PowerGrip® Timing Belt  
Tooth/Groove Contact**

## **PowerGrip® GT®3 Belts are an advanced design of Gates HTD® system and feature:**

- a modified curvilinear belt tooth profile with mating sprocket groove.
- registration and indexing accuracy equivalent to the conventional PowerGrip Timing Belt System.
- a higher load-carrying capacity and longer belt life than either PowerGrip HTD or Timing belts.

It's difficult to make a true quantitative comparison between the backlash of a trapezoidal tooth drive and PowerGrip® GT®3 tooth drive due to the difference in "sprocket to belt tooth" fit. (See illustrations at left). Trapezoidal belts contact the sprocket in the root radius — upper flank area only, while the PowerGrip® GT®3 system permits full flank contact.

The main stress line in a trapezoidal tooth timing belt is at the tooth base. During operation stress greatly reduces belt life. The PowerGrip® GT®3 system overcomes this with complete tooth flank contact... which eliminates the tooth stress line area. This greatly increases belt life and prevents tooth distortion caused by drive torque. In addition, the conventional timing belt has a chordal effect as it wraps small sprockets. This is significantly reduced in the PowerGrip® GT®3 system due to full tooth support along the sprocket. Full support improves meshing, reduces vibration and minimizes tooth deformation.

On drives using a low installation tension, small pulleys, and light loads, the backlash of the PowerGrip® GT®3 system will be slightly better than the trapezoidal timing belt system. However, with increased tension and/or loads and/or sprocket sizes, the performance of the PowerGrip® GT®3 system becomes significantly better than the trapezoidal timing belt system.

HTD was developed for high torque drive applications, but is not acceptable for most precision indexing or registration applications. The HTD design requires substantial belt tooth to sprocket groove clearance (backlash) to perform. As smaller diameter sprockets are used, the clearance required to operate properly is increased. HTD drive clearance, using small diameter sprockets, is approximately four times greater than an equivalent timing belt drive.

## **The PowerGrip® GT®3 deep tooth profile provides...**

- increased contact area and improves resistance to ratcheting.
- easy, clean entering and exiting the sprocket grooves...resulting in reduced vibration.
- parallel contact with the groove and eliminates stress concentrations and tooth deformation under load.
- improved registration characteristics and maintains high torque carrying capability.

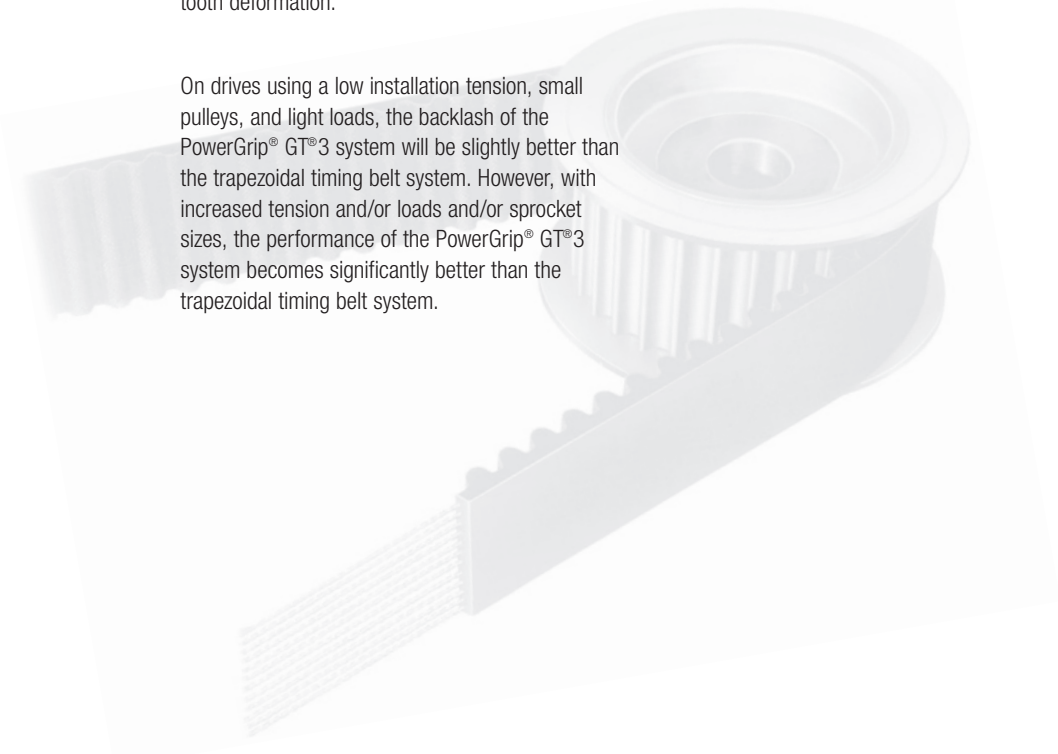



# Introduction – PowerGrip® GT®3 Belt Drives

**This PowerGrip® GT®3 synchronous belt fits in tight, hard to fit applications with room to spare.**

## Lasts longer than competitive belts

PowerGrip® GT®3 belts outlast the competition in these ways:

- Deep tooth profile provides superior load-carrying strength and reduces ratcheting when using Gates sprockets.
- A durable nylon fabric tooth covering increases tooth strength and provides wear and abrasion resistance.
- Fiberglass tensile cords wrapped in a durable neoprene body provide flexibility and increase service life.

## Precision registration

PowerGrip® GT®3 belts provide timing and synchronization accuracy for flawless registration, with no loss of torque carrying capability.

## Increases load-carrying capacity

Load capacities exceed HTD and trapezoidal belt capabilities...making PowerGrip® GT®3 the choice for accurate registration, heavy loads and small sprockets. Smaller and tougher than HTD or trapezoidal belts, PowerGrip® GT®3 belts give engineers more space-saving flexibility for micro-technology.

## Sounds this quiet ...

PowerGrip® GT®3 belt's specially engineered teeth reduce noise and vibration. Clean meshing and reduced belt width results in noise reduction when compared to PowerGrip Timing and HTD belts.

## When precision is critical, depend on PowerGrip®GT®3 belts

PowerGrip® GT®3 belts are designed for precision applications. Custom-built constructions are available for applications requiring maximum performance. Worldwide manufacturing capabilities assure you of prompt service for important markets.

PowerGrip® GT® 3 belts are available in 2mm, 3mm and 5mm pitches. Larger 8mm and 14mm pitch belts are also available. See Catalog 17195 - PowerGrip® GT® 3 Belt Drive Design Manual.

## Here are some of the many PowerGrip® GT®3 belt applications:

- data storage equipment
- machine tools
- hand power tools
- postage handling equipment
- DC stepper/servo applications
- food processors
- centrifuges
- printers
- floor care equipment
- money handling equipment
- medical diagnostic equipment
- sewing machines
- automated teller machines
- ticket dispensers
- plotters
- copiers
- robotics equipment
- vending equipment
- vacuum cleaners
- office equipment

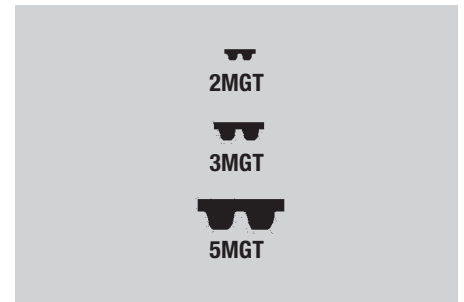

**PowerGrip® GT®3 Belt Profiles/Pitches**

**PowerGrip® GT®3 Belt Drives  
Pages 13-35**



# Introduction – PowerGrip® HTD® Belt Drives

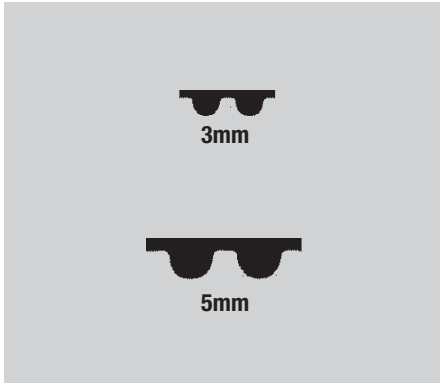

**PowerGrip® HTD® Belt Profiles/Pitches**

## Good torque carrying capability and design versatility

PowerGrip HTD drives provide advantages over conventional gear and chain type drives...

- run quiet
- do not need lubricating
- require virtually zero maintenance
- high reliability and low operating costs

Gates 3mm and 5mm pitch HTD belts are capable of operating at both low and high speeds while carrying heavy loads. They can provide higher speed ratios than comparable XL and L pitch timing belts in the same space. Compared to conventional timing belts, they transmit the same power in a more compact drive package.

HTD belts have the same characteristics as larger 8mm and 14mm pitch belts, but are designed for smaller horsepower and higher speed requirements.

3mm and 5mm pitch HTD belts provide positive non-slip power transmission with many advantages over conventional drive systems. They can handle tough applications, even those subject to sudden shock and overloading.

## Some PowerGrip HTD Belt Applications are:

- floor polishers
- vacuum cleaners
- sewing machines
- sanders
- office equipment
- planers
- centrifuges
- diagnostic equipment
- power tools
- vending machines
- juicers

**PowerGrip HTD Drives ..... Pages 36-45**

## PowerGrip® Timing Belt Drives



**PowerGrip® Timing Belt Profiles/Pitches**

## Provide positive, non-slip power transmission

PowerGrip Timing Belts are a good standard line product with a history of reliability. Around for over 60 years, this product line was the flagship of synchronous power transmission prior to Gates introduction of PowerGrip HTD and GT Belts.

Gates timing belts are made with a true design pitch, a standard of the Rubber Manufacturers Association and the International Standards Organization.

## PowerGrip Timing Belts Application Types:

- office equipment
- money handling equipment
- food processors
- medical equipment
- robotics
- data processing equipment
- miniaturized applications
- mailing equipment
- printers/plotters

**PowerGrip Timing Drives Pages ..... 46-50**

# Introduction – PowerGrip® Twin Power® Belt Drives



0.200" (1/5") pitch extra light (XL)

**PowerGrip Twin Power Timing Belt Profile/Pitch**



3mm



5mm

**PowerGrip Twin Power HTD Timing Belt Profile/Pitch**



3mm



5mm

**PowerGrip Twin Power GT2 Timing Belt Profile/Pitch**

## Dual driving surfaces allow for unique, problem solving drive designs

Gates Twin Power Belts have teeth on both sides to provide synchronization from both driving surfaces. This feature makes possible drive designs such as multi-point drives, rotation reversal with one belt, serpentine drives, etc. Twin Power belts provide solutions to difficult design problems.

Twin Power Belts are similar in construction to regular synchronous belts, including nylon-faced teeth on both sides. This construction uses essentially the same design parameters as standard synchronous belts. They are rated at the same horsepower capacity as conventional PowerGrip Belts of identical pitch and width on either side of the belt.

**NOTE:** Twin Power Belts are available in GT2, HTD and Timing Belt configurations, so designers can use them in a wide variety of applications.

## Some typical PowerGrip Twin Power applications are:

- copiers
- serpentine drives
- reversing rotations

**PowerGrip GT2 Twin Power Belts ....Pages 22-23**

**PowerGrip HTD Twin Power Belts....Pages 42-43**

**PowerGrip Twin Power Belts .....Pages 51-52**

## PowerGrip® Long Length Belting

### For drives that require belt lengths longer than can be produced in the conventional endless form

PowerGrip Long-length Belting has the same basic construction as conventional Gates timing belts. Gates can make continuous belting in spiral cut form on a made-to-order basis.

For information or assistance on any long length belt problem, contact Gates Product Application Engineering.

### Typical PowerGrip Long Length Belting uses are:

- reciprocating carriage drives
- rack and pinion drives
- large plotters

**PowerGrip Long Length Belting .....Page 54**

**Clamp Plate Specifications .....Page 55**



# Introduction – Polyflex® JB® Belt Drives

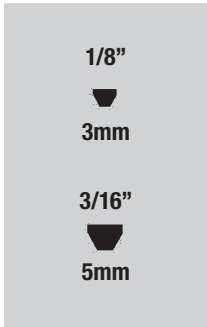

Standard Polyflex® Belt Profile

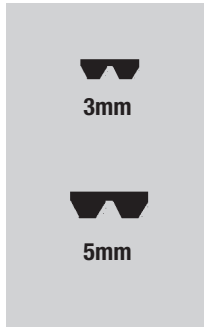

Polyflex® JB Belt Profile

## Gates Polyflex® JB® is a joined belt with a different angle

“High Power Density” is what you get from this high-precision belt. Developed by Gates and produced using patented manufacturing processes, Polyflex JB belts provide load-carrying capacity at higher speeds on precision applications. Polyflex JB belts can operate at shaft speeds well in excess of 10,000 rpm.

Polyflex JB features joined belt construction for stability. Backside ribs relieve bending stress on small sheaves and provide lateral rigidity. The 60° angle provides more undercord support to the tensile section and distributes the load evenly.

The small cross-section allows belts to be used on short centers and small diameter sheaves for “cleaner” machine designs. It virtually eliminates the need for double-reduction drives and lets you use more cost-effective single-reduction drives.

Gates Polyflex JB belts are a homogenous product. State-of-the-art manufacturing processes assure uniformity of construction, resulting in minimal vibration and smooth operation on precision applications.

Gates special high modulus polyurethane compound has a high coefficient of friction that resists fatigue, wear, ozone and most adverse environmental conditions.

**Cost Savings — PLUS!** Polyflex JB belts bring V-belt economy and simplicity to applications where conventional V-belts are not feasible, resulting in cost savings and design freedom never before possible.

## Typical Polyflex JB applications are:

- computer peripherals
- bench-type milling machines
- glass blowing lathes
- valve grinding machines
- crankshaft grinding machines
- woodworking spindle drives
- horizontal milling machines
- dental grinders
- floor care equipment
- microfiche readers
- drilling machines
- lathe drives
- knife grinders
- scissor sharpeners
- centrifuges
- blowers
- wheelchairs
- optical lens grinders
- fans
- metalworking spindle drives

## Polyflex JB Drives Pages..... 77-81

For additional Polyflex belt data refer to Gates Heavy Duty V-Belt Drive Design Manual #14995-A

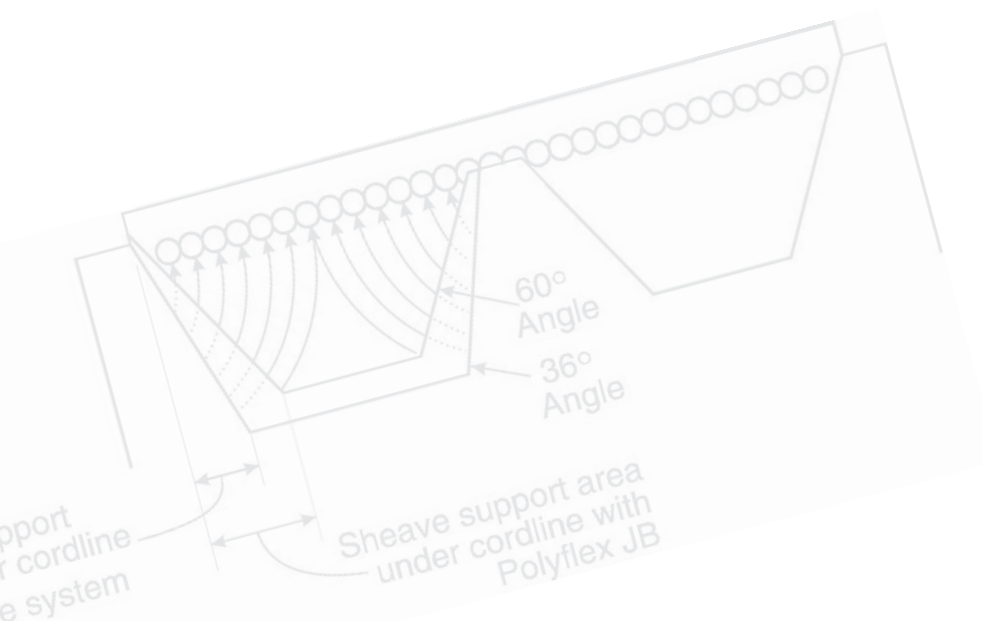



# Introduction – Micro-V® Belt Drives

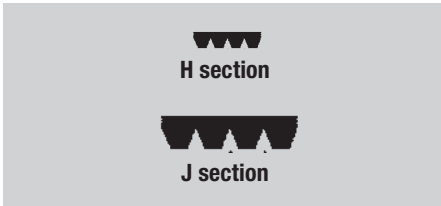

Micro-V Belt Profiles

## For the best ribs around, look no further than Gates Micro-V® Belts

### Truncated tooth profile increases flexibility and reduces heat

Gates Micro-V Belts outperform other V-ribbed belts because the Vees are shorter. The truncated (shortened) profile of the Vees give Gates Micro-V Belts increased flexibility, reduced heat buildup and lets them perform at extra high speeds on smaller diameter sheaves.

### Gates exclusive truncated design gives you...

- 80% higher horsepower capacity than RMA standards.
- extra load-carrying capacity for extra long life.
- Truncated belt ribs for improved wedging in the pulley grooves and greater load capacity.

Micro-V Belts are smooth running and resistant to oil, heat and other adverse conditions. Plus, undercords are static conductive.

## Just some of the applications for Micro-V Belts are:

- high speed machine tools
- milling lathes
- washing machines
- precision surface grinders
- floor polishers
- tool grinders
- high-speed printing presses
- centrifuges
- agitators
- precision center lathes
- pumps
- high-speed atomizers
- trash compactors
- planers and molders
- dryers
- food slicers
- electric massagers
- lawn mowers
- juice mixers
- industrial vacuum cleaners
- microwave ovens
- bakery equipment
- compressors
- fans

## Micro-V Drives Pages ..... 82-83

For additional Micro-V belt data refer to Gates Heavy Duty V-Belt Drive Design Manual 14995-A.

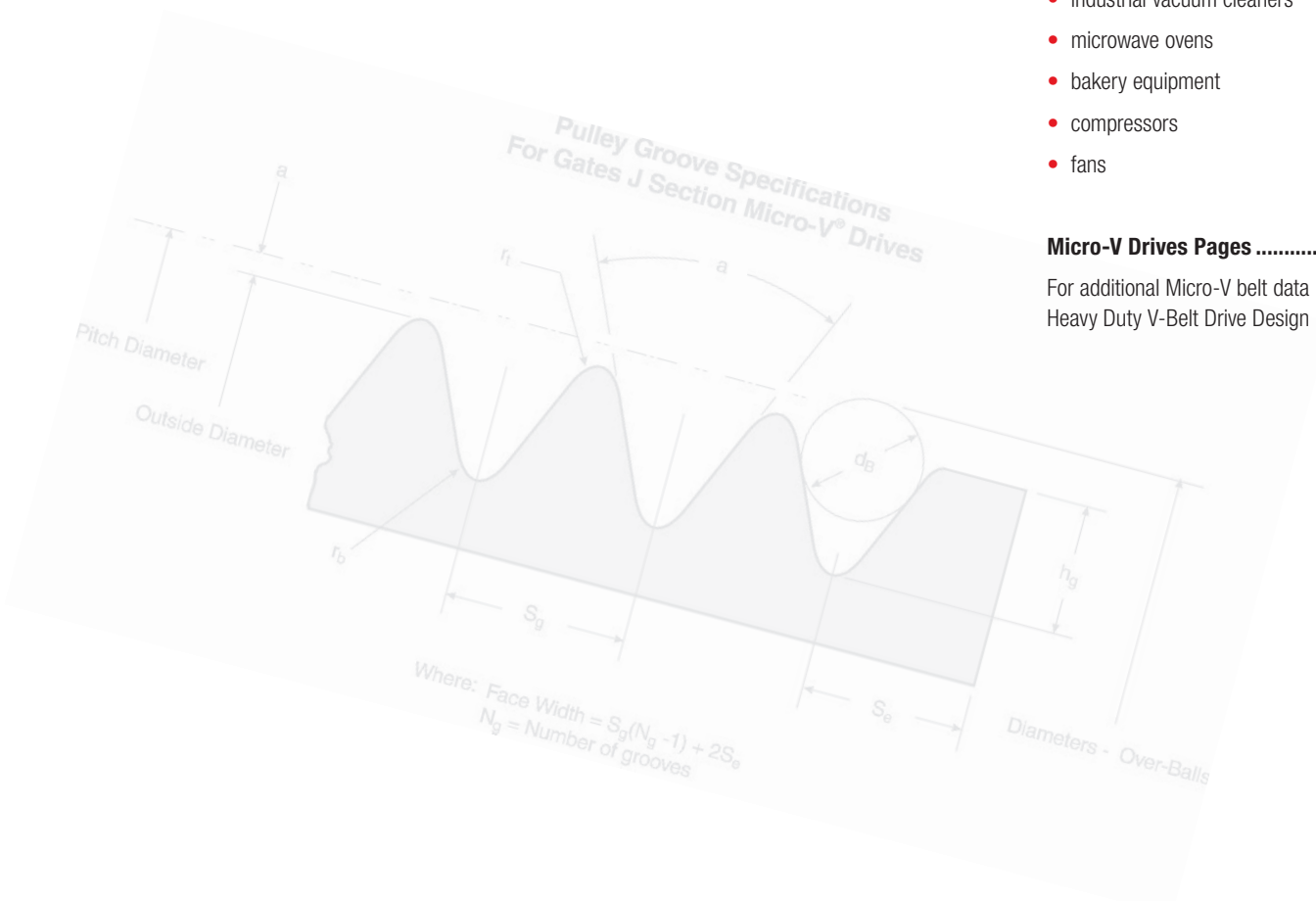

# Drive Comparison Graphs

The following graph contains a representation of horsepower ratings, over a wide speed range, of the belt types represented in this catalog. The sprocket/pulley/sheave diameters and belt widths are all comparable for a realistic comparison of product capability.

### High Speed Drive Rating Graph Comparable Diameters & Widths

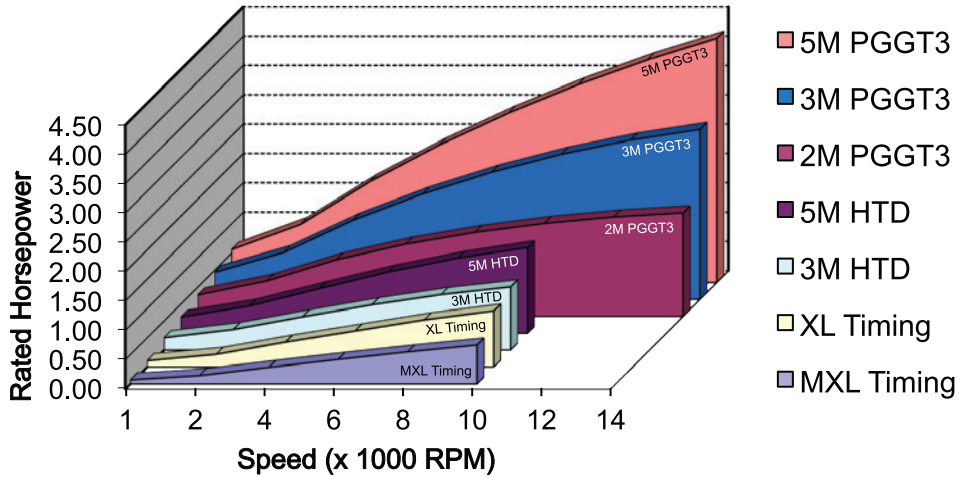

The following graph provides a comparison of the rated torque carrying capabilities of synchronous belts, on small diameter sprockets/pulleys at low speeds. The sprocket/ pulley diameters and belt widths are all comparable for a realistic comparison.

### Low Speed Drive Rating Graph Comparable Diameters & Widths

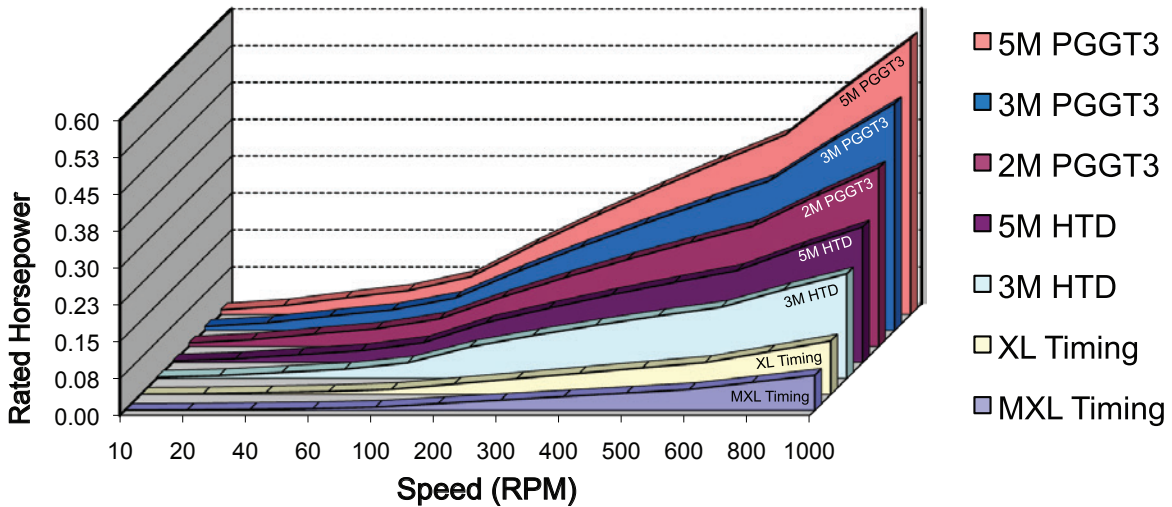

# Synchronous Drive Comparisons

Designers and engineers find that PowerGrip belt drives provide exceptional versatility and reliability. Small and lighter weight drive packages can be used in a wide variety of applications. PowerGrip drives also offer efficient operation over a wide range of loads and speeds.

## Drive Package Comparison

**Compact, space saving belt drives can be designed with high-performance drive systems like PowerGrip® GT<sup>3</sup>. As illustrated, PowerGrip® GT<sup>3</sup> drives are significantly narrower than comparably designed PowerGrip HTD and PowerGrip Timing Belt drives, resulting in space, weight and cost savings.**

### 3mm PowerGrip® GT<sup>3</sup> Belt Drive – 6mm

DriveR: 3MR-30S-06 (1.128" P.D.)

DriveN: 3MR-30S-06 (1.128" P.D.)

**Belt Width:** 6mm

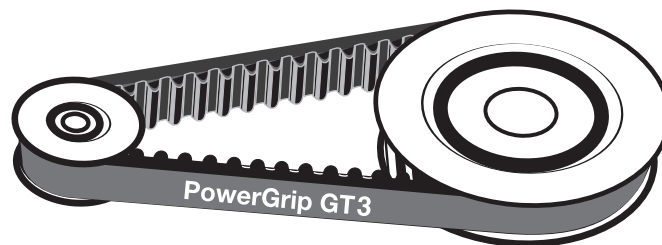

### 3mm PowerGrip HTD® Belt Drive – 15mm

DriveR: P30-3M-15 (1.128" P.D.)

DriveN: P30-3M-15 (1.128" P.D.)

**Belt Width:** 15mm

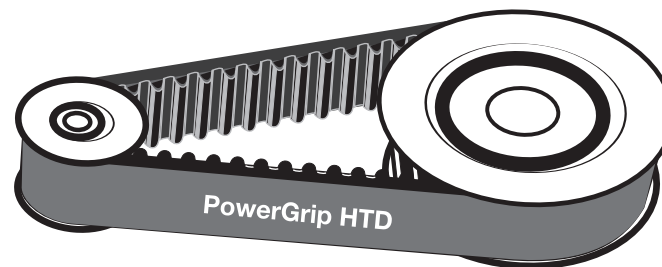

### XL PowerGrip Timing Belt Drive – 31.75mm

DriveR: 18XL125 (1.146" P.D.)

DriveN: 18XL125 (1.146" P.D.)

**Belt Width:** 1.25" (31.75mm)

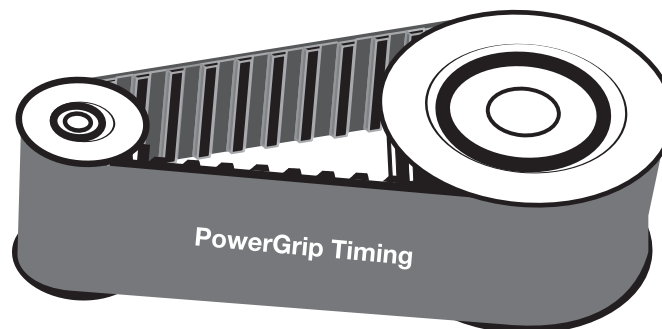

# Synchronous Drive Comparisons – continued

The development of the PowerGrip® GT®3 belt has produced an impressive range of enhanced properties and subsequent design opportunities for engineers.

The following comparative studies have been included to allow designers to make quantitative assessments and to highlight the most significant improvements and design opportunities.

Particularly significant points from the following comparative studies are:

## Durability

The greatly increased durability of the PowerGrip® GT®3 design has resulted in power capacities far above those quoted for similar size belts. The resulting small drive packages will increase design flexibility, space utilization and cost effectiveness.

## Tooth Jump Resistance

The very significant improvement in tooth jump resistance of PowerGrip® GT®3 when compared to similar belts has several important advantages.

- a. Ratcheting resistance during high start-up torques.
- b. Reduced bearing loads, particularly in fixed-center drives. Lower average tensions can be used without encountering tooth jump at the low-tension end of the tolerance ranges.
- c. Reduced system losses result from lower pre-tensioning, with less potential for tooth jumping.

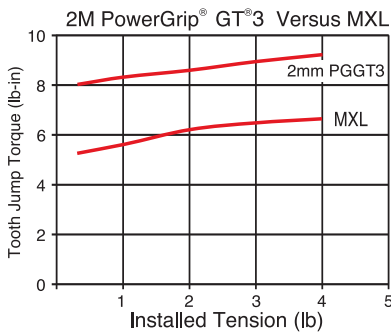

TEST CONDITIONS  
 Speed: 1130 rpm  
 Pulleys: DriveR - 20 grooves  
 DriveN - 20 grooves  
 Belt Width: 4.8mm

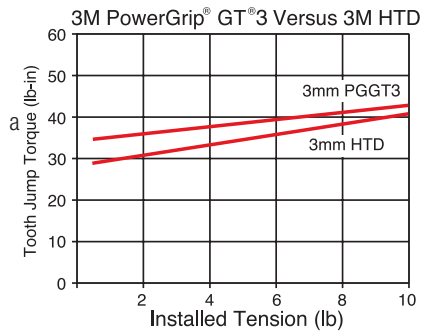

TEST CONDITIONS  
 Speed: 750 rpm  
 Pulleys: DriveR - 30 grooves  
 DriveN - 30 grooves  
 Belt Width: 6mm

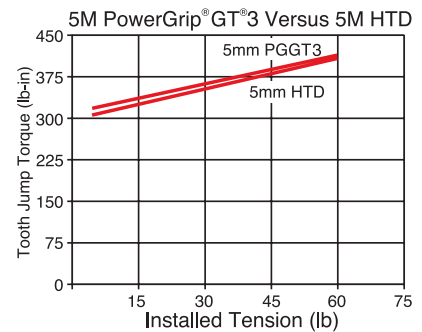

TEST CONDITIONS  
 Speed: 2300 rpm  
 Pulleys: DriveR - 20 grooves  
 DriveN - 20 grooves  
 Belt Width: 15mm

# Synchronous Drive Comparisons - continued

## Noise

The smoother meshing action of the PowerGrip® GT®3 belt, with its optimized design produces significantly lower noise levels when compared with other, similar sized belt types operating under similar speeds and tensions. These improvements are enhanced by the fact that narrower belts can be used due to increased power capacities.

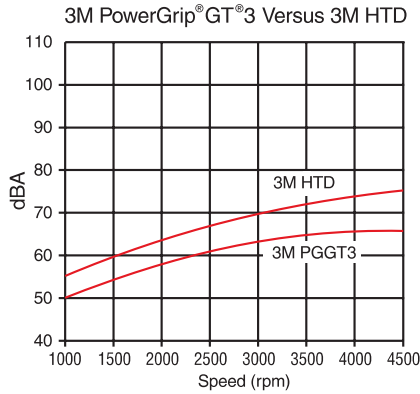

Belt No. of teeth - 188  
Width - 15mm  
Pulleys DriveR - 6 grooves  
DriveN - 26 grooves  
Microphone location midway between the sprockets, 100mm from the belt edge

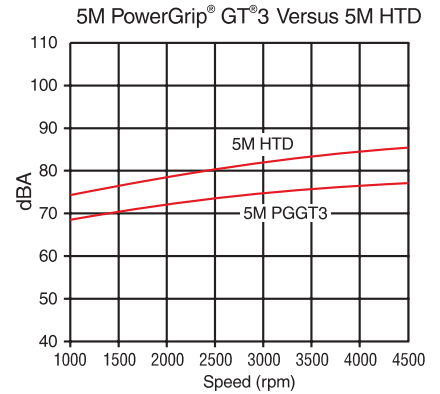

Belt No. of teeth - 118  
Width - 30mm  
Pulleys DriveR - 20 grooves  
DriveN - 20 grooves  
Microphone location midway between the sprockets, 100mm from the belt edge

## Positioning Accuracy

The PowerGrip® HTD® belt tooth forms were primarily designed to transmit high torque loads. This requirement increased tooth to groove clearances which resulted in increased backlash when compared with the original classical designs.

PowerGrip® GT®3 has reversed this with power capacities now exceeding those of PowerGrip® HTD® while giving equivalent or higher levels of positional accuracy than PowerGrip Timing belts.

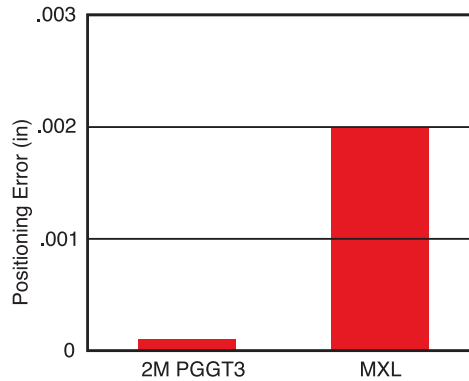

Belt: No. of teeth 126  
Width 8mm  
Pulleys: DriveR 12 grooves  
DriveN 40 grooves  
Installed tension: 1.8 lb  
Motor: 200 steps/cycle

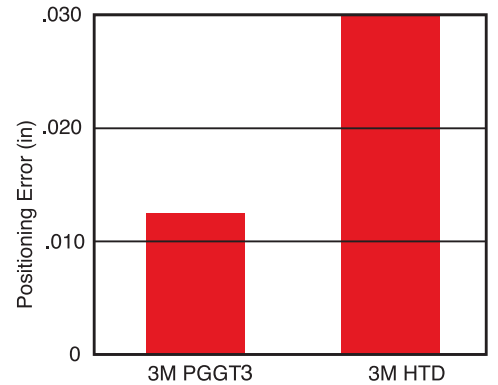

Belt: No. of teeth 92  
Width 6mm  
Pulleys: DriveR 20 grooves  
DriveN 20 grooves  
Installed tension: 6.6 lb  
Motor: 200 steps/cycle



## Drive Selection Procedure – single sided

### Step 1. Determine design load.

Service factors between 1.5 and 2.0 are generally recommended when designing small pitch synchronous drives. Knowledge of drive loading characteristics should influence the actual value selected. A higher service factor should be selected for applications with high peak loads, high operating speeds, unusually severe operating conditions, etc. Lower service factors can be used when the loading is smooth, well defined, etc. and the reliability is less critical. Some designs may require service factors outside the 1.5 to 2.0 range, depending upon the nature of the application. Contact Gates Product Application Engineering for additional information.

Stall torque of the driveR, or peak torque of the driveN unit, may be part of the nameplate data. If not, calculate Torque (Q) by using these formulas:

$$Q \text{ (lb - in)} = \frac{63,025 \times \text{Shaft HP}}{\text{Shaft RPM}}$$

$$Q \text{ (lb - in)} = 8.85 \times Q \text{ (N - m)}$$

$$Q \text{ (oz - in)} = 16 \times Q \text{ (lb - in)}$$

$$\text{Peak Design Load} = \text{Load} \times \text{Service Factor}$$

**NOTE: When performing drive calculations based upon torque loads, drive input/output power is constant but drive input/output torque is not. Drive input/output torque is a function of the speed ratio. Drive designs should be based upon the smaller, faster sprocket, at the torque load calculated for its operating speed. These critical drive parameters should be used for all engineering calculations. See engineering calculations on Page 103 for additional formulas and unit conversions.**

### Step 2. Determine belt pitch and select sprockets.

- Select Belt Pitch by using the Belt Pitch Selection Guide on pages 25, 41 and 53.
- Determine the speed ratio by dividing the larger speed, Sprocket Pitch Diameter or Sprocket Groove Number by the lesser speed, Sprocket Pitch Diameter or Sprocket Groove Number.
- Refer to the appropriate Sprocket Diameter Tables on pages 29-31, pages 46-49 or page 57-58. Select sprockets based upon speed ratio and drive requirements. Use stock sprocket sizes whenever possible.

- Check the Belt Speed, V, of the smaller sprocket selected, using the following formula:

$$V \text{ (fpm)} = 0.262 \times \text{Sprocket PD (in)} \times \text{Sprocket RPM}$$

$$V \text{ (m/s)} = 0.000524 \times \text{Sprocket PD (mm)} \times \text{Sprocket RPM}$$

and,  

$$\text{m/s} = 0.00508 \times \text{fpm}$$

**NOTE:** Belt speeds in excess of 6,500 fpm (33.02 m/s) require special sprocket materials and dynamic balancing.

### Step 3. Determine belt length and nominal center distance.

- Using the allowable range of center distances required by the drive design, calculate the belt Pitch Length (PL) using the following formula:

$$PL = 2CD + [1.57 \times (PD + pd)] + \frac{(PD - pd)^2}{4CD}$$

Where CD = Drive center distance (in)  
 PD = Large pitch diameter (in)  
 pd = Small pitch diameter (in)

Using the calculated range of pitch lengths, select a belt of the proper length from the appropriate belt length table. Use a standard length as shown in the tables on pages 15-16, pages 39-40 or pages 51-52, if possible.

- The approximate nominal center distance for the drive can be calculated using the following formula:

$$\text{Center distance} = \frac{K + \sqrt{K^2 - 32(PD - pd)^2}}{16}$$

Where K = 4PL - 6.28 (PD + pd)  
 PD = Large pitch diameter (in)  
 pd = Small pitch diameter (in)  
 PL = Belt pitch length (in)

See Engineering calculations on page 103 or contact Gates Product Application Engineering for accuracy within 0.001".

### Step 4. Determine belt width.

Belt Width Selection Tables on pages 18-21, pages 42-43 and page 54 show the load ratings for the stock widths of each of the stock belt pitches. Using the smaller sprocket groove number and rpm as determined in Step 2, locate a torque or horsepower rating in the Belt Width Selection

Tables of the proper belt pitch nearest to, but greater than, the peak design load from Step 1. Torque or horsepower ratings for various belt widths can be calculated by multiplying the table rating by the appropriate belt width multiplier.

When designing with PowerGrip® GT®3 or HTD, use the belt length from Step 3 to find the proper belt length factor in the Length Factor Tables included with each Belt Width Selection table. Multiply the torque rating selected above by the belt length factor to obtain the corrected rating. For all designs, the torque or horsepower rating must be equal to, or greater than, the peak design load of Step 1.

**NOTE: The torque or horsepower ratings are based on 6 or more teeth in mesh for the smaller sprocket. Calculate the teeth in mesh for the selected drive design using the Teeth In Mesh Formula on Page 104. If the teeth in mesh is less than 6, the drive must be de-rated as indicated, which may require redesign for additional drive capacity.**

### Step 5. Determine proper belt installation tension.

Procedures to calculate proper belt installation tension for specific applications are included on pages 65-66.

### Step 6. Check and specify drive components.

After the drive system components have been selected and checked against drive system requirements, contact Gates Product Application Engineering before going into production.

Helpline: (303)744-5800  
 E-mail: [ptpasupport@gates.com](mailto:ptpasupport@gates.com)

# PowerGrip® GT®3 Belt Drives

## Belt Construction

PowerGrip® GT®3 drives provide positive, trouble-free power transmission in low-speed high-torque applications and offer many advantages over conventional chain, gear and other belt drives.

### Advantages:

- Higher capacity
- Improved registration
- Reduced noise
- No lubrication required
- Minimal elongation due to wear
- Corrosion resistance
- Excellent abrasion resistance
- Clean operation
- Long trouble-free service

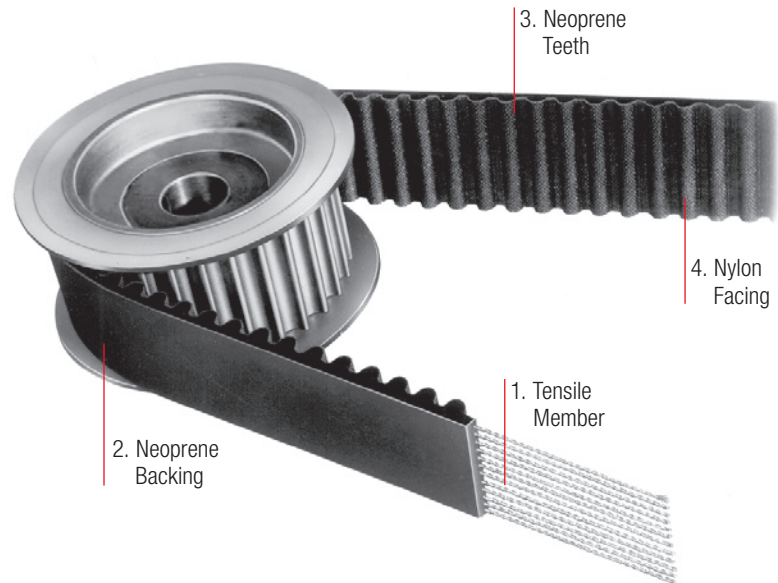

## Construction Features

The tooth design substantially improves stress distribution and allows heavy loading. The molded teeth enter and leave the sprocket grooves smoothly with negligible friction – functioning in much the same way as teeth on a gear.

Construction consists of these components:

- 1. Tensile Member** – Provides high strength, excellent flex life and high resistance to elongation.
- 2. Neoprene Backing** – Strong Neoprene bonded to the tensile member for protection against grime, oil and moisture. It also protects from frictional wear if idlers are used on the back of the belt.
- 3. Neoprene Teeth** – Shear-resistant Neoprene compound is molded integrally with the Neoprene backing. They are precisely formed and accurately spaced to assure smooth meshing with the sprocket grooves.
- 4. Nylon Facing** – Tough nylon fabric with a low coefficient of friction covers the wearing surfaces of the belt. It protects the tooth surfaces and provides a durable wearing surface for long service.

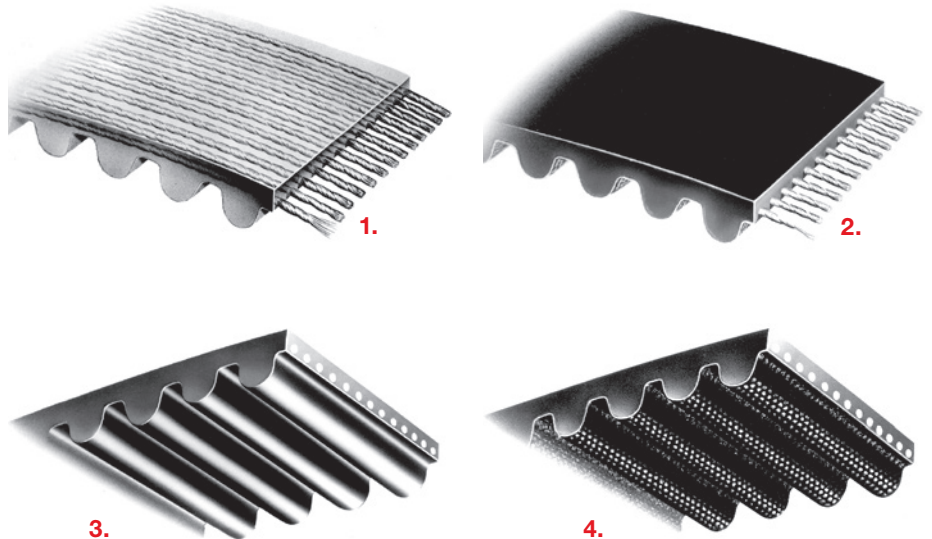

## Single Sided Belt Drive Systems

Gates 2mm, 3mm and 5mm pitch PowerGrip® GT®3 belts have helically-wound fiberglass tension members embedded in a Neoprene body with the belt teeth faced with a tough wear-resistant nylon fabric.

As shown below, three principal dimensions of a belt (Pitch, Pitch Length and Width) in millimeters are used to specify a PowerGrip® GT®3 belt:

300	3MGT	09
Pitch Length	Pitch	Width

Belt pitch is the distance in millimeters between two adjacent tooth centers as measured on the pitch line of the belt. Belt pitch length is the total length (circumference) in millimeters as measured along the pitch line. The theoretical pitch line of a PowerGrip® GT®3 belt lies within the tensile member.

Three principal dimensions of a sprocket – number of grooves, pitch and belt width in millimeters – are used to specify a PowerGrip® GT®3 sprocket as shown below:

3MR	22S	09
Pitch	Number of Grooves	Belt Width

PowerGrip® GT®3 drives have a higher load capacity than PowerGrip® HTD® and PowerGrip® Timing drives. They also feature equivalent or better backlash characteristics when compared to PowerGrip® Timing drives. These attributes make PowerGrip® GT®3 the drive of choice for today's design engineers.

PowerGrip® GT®3 belts must run in PowerGrip® GT®2 sprockets. PowerGrip® GT®3 belts are not compatible with PowerGrip® HTD® sprockets, or any other sprockets available on the market.

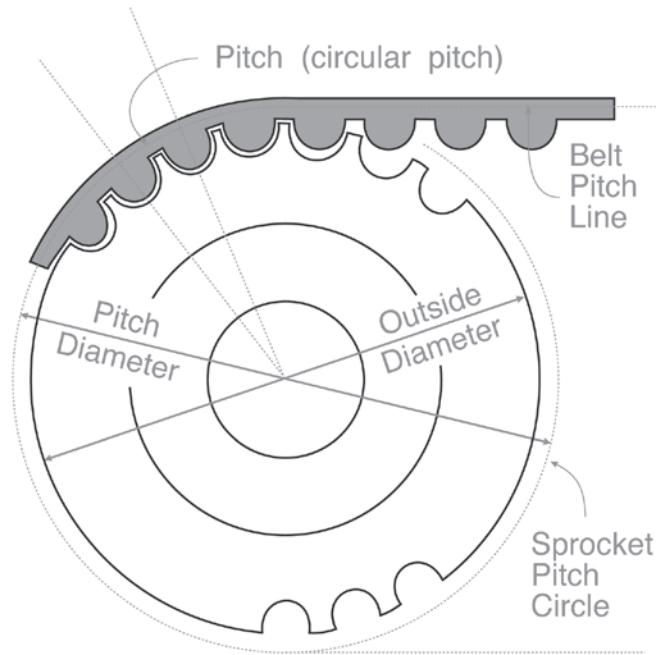

2mm Pitch - Reference Dimensions

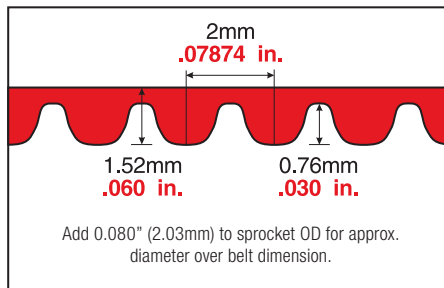

5mm Pitch - Reference Dimensions

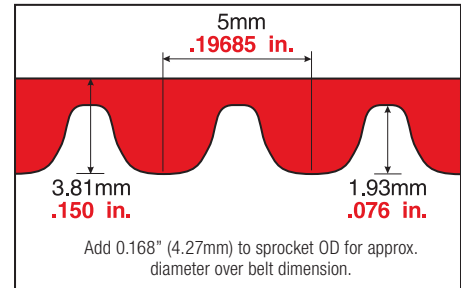

3mm Pitch - Reference Dimensions

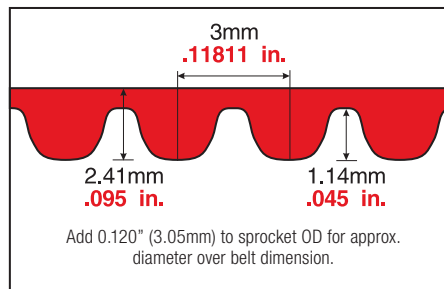

# PowerGrip® GT®3 Belt Drives

## PowerGrip® GT®3 Belt Lengths and Widths

### 2mm Pitch Belt Lengths

Description	Pitch Length (mm)	Pitch Length (in)	No. of Teeth	Description	Pitch Length (mm)	Pitch Length (in)	No. of Teeth	Description	Pitch Length (mm)	Pitch Length (in)	No. of Teeth	Description	Pitch Length (mm)	Pitch Length (in)	No. of Teeth
2MR-74	74	2.913	37	•2MR-186	186	7.323	93	2MR-286	286	11.260	143	•2MR-456	456	17.953	228
2MR-76	76	2.992	38	•2MR-192	192	7.559	96	2MR-288	288	11.339	144	•2MR-470	470	18.504	235
•2MR-100	100	3.937	50	•2MR-200	200	7.874	100	•2MR-300	300	11.811	150	•2MR-474	474	18.661	237
•2MR-112	112	4.409	56	•2MR-202	202	7.953	101	2MR-318	318	12.520	159	•2MR-488	488	19.213	244
•2MR-124	124	4.882	62	2MR-208	208	8.189	104	•2MR-320	320	12.598	160	2MR-502	502	19.764	251
•2MR-126	126	4.961	63	•2MR-210	210	8.268	105	•2MR-322	322	12.677	161	•2MR-504	504	19.843	252
•2MR-130	130	5.118	65	•2MR-212	212	8.346	106	•2MR-332	332	13.071	166	•2MR-528	528	20.787	264
•2MR-132	132	5.197	66	•2MR-216	216	8.504	108	•2MR-346	346	13.622	173	•2MR-544	544	21.417	272
•2MR-134	134	5.276	67	•2MR-220	220	8.661	110	•2MR-350	350	13.780	175	•2MR-552	552	21.732	276
•2MR-136	136	5.354	68	2MR-224	224	8.819	112	2MR-356	356	14.016	178	•2MR-576	576	22.677	288
•2MR-140	140	5.512	70	•2MR-232	232	9.134	116	•2MR-364	364	14.331	182	•2MR-600	600	23.622	300
2MR-142	142	5.591	71	•2MR-236	236	9.291	118	•2MR-370	370	14.567	185	•2MR-640	640	25.197	320
•2MR-152	152	5.984	76	•2MR-240	240	9.449	120	•2MR-380	380	14.961	190	2MR-660	660	25.984	330
•2MR-158	158	6.220	79	2MR-242	242	9.528	121	•2MR-386	386	15.197	193	•2MR-696	696	27.402	348
•2MR-160	160	6.299	80	•2MR-250	250	9.843	125	2MR-392	392	15.433	196	•2MR-744	744	29.291	372
•2MR-164	164	6.457	82	•2MR-252	252	9.921	126	•2MR-400	400	15.748	200	•2MR-848	848	33.386	424
•2MR-166	166	6.535	83	•2MR-258	258	10.157	129	•2MR-406	406	15.984	203	•2MR-1164	1164	45.827	582
•2MR-168	168	6.614	84	2MR-264	264	10.394	132	•2MR-420	420	16.535	210	2MR-1700	1700	66.929	850
•2MR-172	172	6.772	86	•2MR-278	278	10.945	139	2MR-428	428	16.850	214				
•2MR-180	180	7.087	90	•2MR-280	280	11.024	140	2MR-430	430	16.929	215				

Stock lengths are denoted by a •. All other sizes, contact Gates Customer Service for availability.

### 2mm Pitch Stock Belt Widths

Belt Width Code	Belt Width (mm)	Belt Width (in)
04	4	0.157
06	6	0.236
09	9	0.354

### 3mm Pitch Belt Lengths

Description	Pitch Length (mm)	Pitch Length (in)	No. of Teeth	Description	Pitch Length (mm)	Pitch Length (in)	No. of Teeth	Description	Pitch Length (mm)	Pitch Length (in)	No. of Teeth	Description	Pitch Length (mm)	Pitch Length (in)	No. of Teeth
•3MR-99	99	3.898	33	3MR-252	252	9.921	84	3MR-408	408	16.063	136	•3MR-552	552	21.732	184
•3MR-111	111	4.370	37	•3MR-255	255	10.039	85	•3MR-414	414	16.299	138	•3MR-564	564	22.205	188
•3MR-123	123	4.843	41	•3MR-267	267	10.512	89	•3MR-420	420	16.535	140	•3MR-600	600	23.622	200
•3MR-129	129	5.079	43	•3MR-282	282	11.102	94	•3MR-447	447	17.598	149	•3MR-630	630	24.803	210
•3MR-159	159	6.260	53	3MR-285	285	11.220	95	•3MR-450	450	17.717	150	•3MR-684	684	26.929	228
•3MR-165	165	6.496	55	•3MR-291	291	11.457	97	•3MR-474	474	18.661	158	•3MR-735	735	28.937	245
•3MR-180	180	7.087	60	•3MR-300	300	11.811	100	•3MR-480	480	18.898	160	•3MR-750	750	29.528	250
•3MR-183	183	7.205	61	•3MR-339	339	13.346	113	•3MR-483	483	19.016	161	•3MR-786	786	30.945	262
•3MR-189	189	7.441	63	•3MR-348	348	13.701	116	•3MR-489	489	19.252	163	•3MR-840	840	33.071	280
3MR-195	195	7.677	65	•3MR-357	357	14.055	119	3MR-495	495	19.488	165	•3MR-945	945	37.205	315
•3MR-201	201	7.913	67	•3MR-360	360	14.173	120	3MR-501	501	19.724	167	•3MR-1050	1050	41.339	350
•3MR-219	219	8.622	73	3MR-363	363	14.291	121	•3MR-504	504	19.843	168	•3MR-1080	1080	42.520	360
•3MR-225	225	8.858	75	•3MR-375	375	14.764	125	3MR-510	510	20.079	170	•3MR-1536	1536	60.472	512
•3MR-240	240	9.449	80	3MR-390	390	15.354	130	3MR-513	513	20.197	171	•3MR-1587	1587	62.480	529
•3MR-243	243	9.567	81	•3MR-393	393	15.472	131	•3MR-537	537	21.142	179	•3MR-2061	2061	81.142	687

Stock lengths denoted by a •. All other sizes, contact Gates Customer Service for availability.

### 3mm Pitch Stock Belt Widths

Belt Width Code	Belt Width (mm)	Belt Width (in)
06	6	0.236
09	9	0.354
15	15	0.591



# PowerGrip® GT®3 Belt Drives

## PowerGrip® GT®3 Belt Lengths and Widths - Continued

### 5mm Pitch Belt Lengths

Description	Pitch Length		No. of Teeth	Description	Pitch Length		No. of Teeth	Description	Pitch Length		No. of Teeth	Description	Pitch Length		No. of Teeth
	(mm)	(in)			(mm)	(in)			(mm)	(in)			(mm)	(in)	
5MR-225	225	8.858	45	•5MR-375	375	14.764	75	5MR-550	550	21.654	110	•5MR-900	900	35.433	180
5MR-250	250	9.843	50	•5MR-400	400	15.748	80	•5MR-565	565	22.244	113	5MR-950	950	37.402	190
5MR-265	265	10.433	53	•5MR-405	405	15.945	81	•5MR-575	575	22.638	115	•5MR-1000	1000	39.370	200
5MR-275	275	10.827	55	5MR-410	410	16.142	82	•5MR-580	580	22.835	116	5MR-1050	1050	41.339	210
5MR-285	285	11.220	57	•5MR-425	425	16.732	85	•5MR-600	600	23.622	120	•5MR-1150	1150	45.276	230
•5MR-300	300	11.811	60	•5MR-450	450	17.717	90	•5MR-625	625	24.606	125	•5MR-1300	1300	51.181	260
5MR-325	325	12.795	65	5MR-460	460	18.110	92	•5MR-650	650	25.591	130	•5MR-1450	1450	57.087	290
5MR-330	330	12.992	66	5MR-475	475	18.701	95	•5MR-700	700	27.559	140	•5MR-1600	1600	62.992	320
5MR-340	340	13.386	68	•5MR-500	500	19.685	100	•5MR-750	750	29.528	150	•5MR-1720	1720	67.717	344
5MR-350	350	13.780	70	5MR-525	525	20.669	105	•5MR-800	800	31.496	160	•5MR-1755	1755	69.094	351
•5MR-355	355	13.976	71	•5MR-535	535	21.063	107	•5MR-815	815	32.087	163	•5MR-2100	2100	82.677	420
5MR-360	360	14.173	72	5MR-540	540	21.260	108	•5MR-850	850	33.465	170	5MR-2440	2440	96.063	488

Stock lengths are denoted by a •. All other sizes, contact Gates Customer Service for availability.

### 5mm Pitch Stock Belt Widths

Belt Width Code	Belt Width (mm)	Belt Width (in)
09	9	0.354
15	15	0.591
25	25	0.984



## Belt Pitch Selection Guide

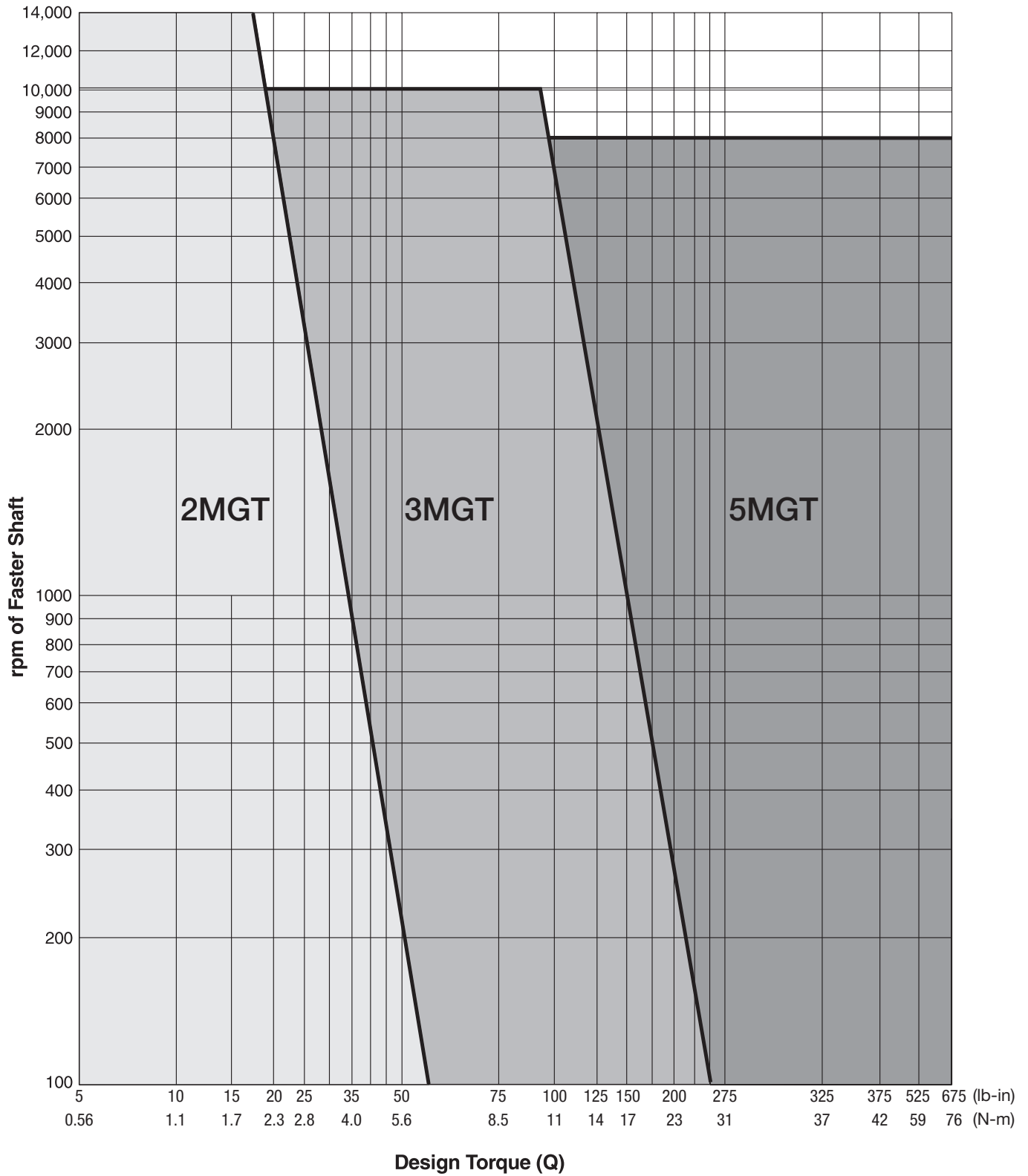

# PowerGrip® GT®3 Belt Drives

## Belt Width Selection Tables – 2mm PowerGrip® GT®3 Belts

The following table represents the torque ratings for each belt in its base width at the predetermined number of grooves, pitch diameters and rpm. These ratings must be multiplied by the appropriate width factor and applicable belt length factor to obtain the corrected torque rating. (See Step 4 of Drive Selection Procedure on Page 12.)

Belt Width (mm)	4	6	9	12
Width Multiplier	0.60	1.00	1.64	2.32

### 2MGT Rated Torque (lb-in) for Small Sprocket - 6mm Belt Width

Number of Grooves	12	14	16	18	20	22	24	26	28	30	34	38	45	50	56	62	74	80
Pitch (mm)	7.64	8.91	10.18	11.45	12.72	13.99	15.29	16.56	17.83	19.10	21.64	24.18	28.65	31.82	35.66	39.47	47.11	50.93
Diameter (in)	<b>0.301</b>	<b>0.351</b>	<b>0.401</b>	<b>0.451</b>	<b>0.501</b>	<b>0.551</b>	<b>0.602</b>	<b>0.652</b>	<b>0.702</b>	<b>0.752</b>	<b>0.852</b>	<b>0.952</b>	<b>1.128</b>	<b>1.253</b>	<b>1.404</b>	<b>1.554</b>	<b>1.855</b>	<b>2.005</b>
10	7.75	9.17	10.6	12.0	13.3	14.7	16.0	17.4	18.7	20.0	22.6	25.1	29.5	32.6	36.2	39.8	46.9	50.4
20	7.12	8.44	9.74	11.0	12.3	13.5	14.8	16.0	17.2	18.4	20.8	23.1	27.2	30.0	33.3	36.6	43.1	46.2
40	6.50	7.72	8.91	10.1	11.2	12.4	13.5	14.7	15.8	16.9	19.0	21.2	24.8	27.4	30.4	33.4	39.2	42.1
60	6.14	7.29	8.43	9.54	10.6	11.7	12.8	13.9	14.9	16.0	18.0	20.0	23.5	25.9	28.7	31.5	37.0	39.6
100	5.68	6.76	7.81	8.852	9.87	10.9	11.9	12.9	13.8	14.8	16.7	18.5	21.7	23.9	26.6	29.1	34.1	36.6
200	5.05	6.03	6.98	7.92	8.84	9.74	10.6	11.5	12.4	13.2	14.9	16.6	19.4	21.3	23.7	25.9	30.3	32.4
300	4.69	5.60	6.50	7.37	8.23	9.07	9.92	10.7	11.5	12.3	13.9	15.4	18.0	19.8	22.0	24.0	28.0	30.0
400	4.43	5.30	6.15	6.98	7.80	8.60	9.40	10.2	10.9	11.7	13.2	14.6	17.1	18.8	20.8	22.7	26.4	28.3
500	4.23	5.07	5.88	6.68	7.46	8.23	9.00	9.74	10.5	11.2	12.6	14.0	16.3	17.9	19.8	21.7	25.2	26.9
600	4.06	4.88	5.67	6.44	7.19	7.93	8.67	9.38	10.1	10.8	12.1	13.4	15.7	17.2	19.0	20.8	24.2	25.8
800	3.81	4.57	5.32	6.05	6.76	7.46	8.15	8.82	9.48	10.1	11.4	12.6	14.7	16.2	17.8	19.5	22.6	24.1
1000	3.61	4.34	5.05	5.75	6.43	7.09	7.75	8.39	9.01	9.63	10.8	12.0	14.0	15.3	16.9	18.4	21.4	22.8
1200	3.44	4.15	4.83	5.50	6.15	6.79	7.42	8.03	8.63	9.22	10.4	11.5	13.4	14.6	16.1	17.6	20.4	21.7
1400	3.30	3.99	4.65	5.29	5.92	6.53	7.15	7.73	8.31	8.87	9.97	11.0	12.8	14.1	15.5	16.9	19.5	20.7
1600	3.18	3.85	4.49	5.11	5.72	6.31	6.91	7.47	8.03	8.57	9.63	10.7	12.4	13.6	14.9	16.2	18.7	19.9
1800	3.08	3.72	4.35	4.96	5.55	6.12	6.69	7.24	7.78	8.31	9.33	10.3	12.0	13.1	14.4	15.7	18.1	19.2
2000	2.98	3.61	4.22	4.81	5.39	5.95	6.50	7.04	7.56	8.07	9.06	10.0	11.6	12.7	14.0	15.2	17.5	18.6
2400	2.82	3.42	4.00	4.57	5.11	5.65	6.18	6.68	7.18	7.66	8.60	9.50	11.0	12.0	13.2	14.3	16.5	17.5
2800	2.68	3.26	3.82	4.36	4.88	5.39	5.90	6.38	6.85	7.31	8.20	9.06	10.5	11.5	12.6	13.6	15.6	16.6
3200	2.56	3.12	3.66	4.18	4.68	5.17	5.66	6.12	6.57	7.01	7.86	8.68	10.0	11.0	12.0	13.0	14.9	15.7
3600	2.45	3.00	3.52	4.02	4.51	4.98	5.44	5.89	6.32	6.75	7.56	8.34	9.64	10.5	11.5	12.4	14.2	15.0
4000	2.36	2.89	3.39	3.88	4.35	4.80	5.25	5.68	6.10	6.51	7.29	8.04	9.28	10.1	11.1	11.9	13.6	14.4
5000	2.16	2.65	3.12	3.58	4.01	4.44	4.85	5.25	5.63	6.00	6.72	7.40	8.52	9.26	10.1	10.9	12.3	13.0
6000	1.99	2.46	2.90	3.33	3.74	4.13	4.52	4.89	5.24	5.59	6.25	6.87	7.89	8.56	9.31	10.0	11.2	11.8
8000	1.73	2.16	2.56	2.94	3.31	3.66	4.00	4.32	4.63	4.93	5.50	6.03	6.89	7.43	8.04	8.58	9.51	9.90
10000	1.53	1.92	2.29	2.64	2.97	3.28	3.59	3.88	4.15	4.42	4.92	5.37	6.09	6.54	7.02	7.44	8.09	8.32
12000	1.37	1.73	2.07	2.39	2.69	2.98	3.26	3.51	3.76	3.99	4.43	4.82	5.43	5.79	6.16	6.45	6.85	6.95
14000	1.23	1.56	1.88	2.18	2.45	2.72	2.97	3.20	3.42	3.63	4.01	4.35	4.85	5.13	5.39	5.58		

### Rated Torque (N-m)

10	0.88	1.04	1.19	1.35	1.51	1.66	1.81	1.96	2.11	2.26	2.55	2.84	3.33	3.68	4.09	4.50	5.30	5.69
20	0.80	0.95	1.10	1.25	1.39	1.53	1.67	1.81	1.95	2.08	2.35	2.61	3.07	3.39	3.76	4.14	4.86	5.22
40	0.73	0.87	1.01	1.14	1.27	1.40	1.53	1.66	1.78	1.91	2.15	2.39	2.80	3.09	3.44	3.77	4.43	4.75
60	0.69	0.82	0.95	1.08	1.20	1.32	1.45	1.57	1.69	1.80	2.03	2.26	2.65	2.92	3.24	3.56	4.18	4.48
100	0.64	0.76	0.88	1.00	1.12	1.23	1.34	1.45	1.56	1.67	1.89	2.10	2.46	2.71	3.00	3.29	3.86	4.13
200	0.57	0.68	0.79	0.89	1.00	1.10	1.20	1.30	1.40	1.50	1.69	1.87	2.19	2.41	2.67	2.93	3.42	3.66
300	0.53	0.63	0.73	0.83	0.93	1.02	1.12	1.21	1.30	1.39	1.57	1.74	2.04	2.24	2.48	2.71	3.17	3.39
400	0.50	0.60	0.70	0.79	0.88	0.97	1.06	1.15	1.24	1.32	1.49	1.65	1.93	2.12	2.34	2.56	2.99	3.19
500	0.48	0.57	0.66	0.75	0.84	0.93	1.02	1.10	1.18	1.26	1.42	1.58	1.84	2.02	2.24	2.45	2.85	3.04
600	0.46	0.55	0.64	0.73	0.81	0.90	0.98	1.06	1.14	1.22	1.37	1.52	1.77	1.95	2.15	2.35	2.73	2.92
800	0.43	0.52	0.60	0.68	0.76	0.84	0.92	1.00	1.07	1.14	1.29	1.43	1.66	1.83	2.02	2.20	2.55	2.72
1000	0.41	0.49	0.57	0.65	0.73	0.80	0.88	0.95	1.02	1.09	1.22	1.36	1.58	1.73	1.91	2.08	2.41	2.57
1200	0.39	0.47	0.55	0.62	0.70	0.77	0.84	0.91	0.98	1.04	1.17	1.30	1.51	1.65	1.82	1.99	2.30	2.45
1400	0.37	0.45	0.53	0.60	0.67	0.74	0.81	0.87	0.94	1.00	1.13	1.25	1.45	1.59	1.75	1.91	2.20	2.34
1600	0.36	0.43	0.51	0.58	0.65	0.71	0.78	0.84	0.91	0.97	1.09	1.20	1.40	1.53	1.69	1.84	2.12	2.25
1800	0.35	0.42	0.49	0.56	0.63	0.69	0.76	0.82	0.88	0.94	1.05	1.17	1.35	1.48	1.63	1.77	2.04	2.17
2000	0.34	0.41	0.48	0.54	0.61	0.67	0.73	0.80	0.85	0.91	1.02	1.13	1.31	1.44	1.58	1.72	1.98	2.10
2400	0.32	0.39	0.45	0.52	0.58	0.64	0.70	0.75	0.81	0.87	0.97	1.07	1.24	1.36	1.49	1.62	1.86	1.98
2800	0.30	0.37	0.43	0.49	0.55	0.61	0.67	0.72	0.77	0.83	0.93	1.02	1.19	1.29	1.42	1.54	1.76	1.87
3200	0.29	0.35	0.41	0.47	0.53	0.58	0.64	0.69	0.74	0.79	0.89	0.98	1.13	1.24	1.36	1.47	1.68	1.78
3600	0.28	0.34	0.40	0.45	0.51	0.56	0.62	0.67	0.71	0.76	0.85	0.94	1.09	1.19	1.30	1.41	1.60	1.70
4000	0.27	0.33	0.38	0.44	0.49	0.54	0.59	0.64	0.69	0.74	0.82	0.91	1.05	1.14	1.25	1.35	1.54	1.62
5000	0.24	0.30	0.35	0.40	0.45	0.50	0.55	0.59	0.64	0.68	0.76	0.84	0.96	1.05	1.14	1.23	1.39	1.47
6000	0.23	0.28	0.33	0.38	0.42	0.47	0.51	0.55	0.59	0.63	0.71	0.78	0.89	0.97	1.05	1.13	1.27	1.33
8000	0.20	0.24	0.29	0.33	0.37	0.41	0.45	0.49	0.52	0.56	0.62	0.68	0.78	0.84	0.91	0.97	1.07	1.12
10000	0.17	0.22	0.26	0.30	0.34	0.37	0.41	0.44	0.47	0.50	0.56	0.61	0.69	0.74	0.79	0.84	0.91	0.94
12000	0.15	0.20	0.23	0.27	0.30	0.34	0.37	0.40	0.42	0.45	0.50	0.54	0.61	0.65	0.70	0.73	0.77	0.78
14000	0.14	0.18	0.21	0.25	0.28	0.31	0.34	0.36	0.39	0.41	0.45	0.49	0.55	0.58	0.61	0.63		

Length Correction Factor		0.70	0.75	0.80	0.85	0.90	0.95	1.00	1.05	1.10	1.15	1.20
--------------------------	--	------	------	------	------	------	------	------	------	------	------	------

# PowerGrip® GT®3 Belt Drives

## Belt Width Selection Tables – 3mm PowerGrip® GT®3 Belts

The following table represents the torque ratings for each belt in its base width at the predetermined number of grooves, pitch diameters and rpm. These ratings must be multiplied by the appropriate width factor and applicable belt length factor to obtain the corrected torque rating. (See Step 4 of Drive Selection Procedure on Page 12.)

Belt Width (mm)	6	9	12	15
Width Multiplier	1.00	1.64	2.32	3.03

### 3MGT Rated Torque (lb-in) for Small Sprocket - 6mm Belt Width

Number of Grooves	16	18	20	22	24	26	28	30	34	38	45	50	56	62	74	80
Pitch (mm)	15.29	17.19	19.10	21.00	22.91	24.81	26.74	28.65	32.46	36.29	42.97	47.75	53.46	59.20	70.66	76.40
Diameter (in)	<b>0.602</b>	<b>0.677</b>	<b>0.752</b>	<b>0.827</b>	<b>0.902</b>	<b>0.977</b>	<b>1.053</b>	<b>1.128</b>	<b>1.278</b>	<b>1.429</b>	<b>1.692</b>	<b>1.880</b>	<b>2.105</b>	<b>2.331</b>	<b>2.782</b>	<b>3.008</b>
10	18.4	21.3	24.1	27.0	29.8	32.6	35.4	38.1	43.6	49.0	58.4	65.0	72.8	80.6	96.0	103.6
20	17.0	19.8	22.5	25.1	27.8	30.4	33.0	35.6	40.8	45.9	54.7	60.9	68.2	75.5	89.8	96.9
40	15.7	18.3	20.8	23.3	25.8	28.2	30.7	33.1	37.9	42.7	50.9	56.7	63.6	70.3	83.7	90.3
60	14.9	17.4	19.8	22.2	24.6	27.0	29.4	31.7	36.3	40.9	48.7	54.3	60.8	67.3	80.1	86.4
100	14.0	16.3	18.6	20.9	23.1	25.4	27.6	29.9	34.2	38.6	46.0	51.2	57.4	63.5	75.6	81.5
200	12.6	14.8	16.9	19.1	21.2	23.2	25.3	27.4	31.4	35.4	42.3	47.1	52.8	58.4	69.5	74.9
300	11.9	13.9	16.0	18.0	20.0	22.0	24.0	25.9	29.7	33.6	40.1	44.6	50.0	55.4	65.9	71.0
400	11.3	13.3	15.3	17.2	19.2	21.1	23.0	24.9	28.6	32.2	38.5	42.9	48.1	53.3	63.3	68.3
500	10.9	12.8	14.8	16.7	18.5	20.4	22.2	24.1	27.7	31.2	37.3	41.6	46.6	51.6	61.3	66.1
600	10.5	12.4	14.3	16.2	18.0	19.8	21.6	23.4	26.9	30.4	36.3	40.5	45.4	50.2	59.7	64.4
800	9.98	11.8	13.6	15.4	17.2	18.9	20.7	22.4	25.8	29.1	34.8	38.8	43.5	48.1	57.1	61.6
1000	9.55	11.3	13.1	14.8	16.5	18.2	19.9	21.6	24.8	28.1	33.6	37.4	42.0	46.4	55.1	59.4
1200	9.20	10.9	12.7	14.3	16.0	17.7	19.3	20.9	24.1	27.2	32.6	36.3	40.7	45.1	53.5	57.6
1400	8.91	10.6	12.3	13.9	15.6	17.2	18.8	20.4	23.5	26.5	31.8	35.4	39.7	43.9	52.1	56.1
1600	8.65	10.3	12.0	13.6	15.2	16.8	18.3	19.9	22.9	25.9	31.0	34.6	38.8	42.9	50.9	54.8
1800	8.42	10.1	11.7	13.3	14.8	16.4	17.9	19.5	22.4	25.4	30.4	33.9	38.0	42.0	49.8	53.6
2000	8.22	9.84	11.4	13.0	14.5	16.1	17.6	19.1	22.0	24.9	29.8	33.2	37.2	41.2	48.9	52.6
2400	7.87	9.44	11.0	12.5	14.0	15.5	17.0	18.4	21.3	24.1	28.8	32.1	36.0	39.8	47.1	50.7
2800	7.57	9.11	10.6	12.1	13.6	15.0	16.5	17.9	20.6	23.3	27.9	31.2	34.9	38.6	45.7	49.1
3200	7.32	8.82	10.3	11.7	13.2	14.6	16.0	17.4	20.1	22.7	27.2	30.3	34.0	37.5	44.4	47.7
3600	7.09	8.57	10.0	11.4	12.8	14.2	15.6	16.9	19.6	22.2	26.5	29.6	33.1	36.6	43.2	46.4
4000	6.89	8.34	9.76	11.2	12.5	13.9	15.2	16.5	19.1	21.7	25.9	28.9	32.3	35.7	42.1	45.2
5000	6.45	7.85	9.21	10.6	11.9	13.2	14.5	15.7	18.2	20.6	24.6	27.4	30.6	33.8	39.7	42.4
6000	6.10	7.45	8.77	10.1	11.3	12.6	13.8	15.0	17.4	19.7	23.5	26.1	29.2	32.1	37.5	40.0
8000	5.53	6.81	8.05	9.26	10.5	11.6	12.8	13.9	16.1	18.2	21.6	24.0	26.6	29.1	33.5	35.4
10000	5.09	6.30	7.48	8.63	9.75	10.8	11.9	13.0	15.0	16.9	20.0	22.1	24.3	26.3		
12000	4.71	5.87	7.00	8.09	9.15	10.2	11.2	12.2	14.0	15.8	18.5	20.3				
14000	4.39	5.50	6.57	7.61	8.61	9.58	10.5	11.4	13.1	14.7	17.1					

### Rated Torque (N-m)

10	2.08	2.40	2.72	3.05	3.36	3.68	4.00	4.31	4.92	5.54	6.60	7.34	8.23	9.11	10.8	11.7
20	1.93	2.23	2.54	2.84	3.14	3.43	3.73	4.03	4.61	5.18	6.18	6.88	7.71	8.53	10.2	11.0
40	1.78	2.06	2.35	2.63	2.91	3.19	3.47	3.74	4.29	4.83	5.75	6.41	7.18	7.95	9.46	10.2
60	1.69	1.97	2.24	2.51	2.78	3.05	3.32	3.58	4.10	4.62	5.51	6.13	6.87	7.61	9.05	9.77
100	1.58	1.84	2.10	2.36	2.62	2.87	3.12	3.37	3.87	4.36	5.20	5.79	6.49	7.18	8.54	9.21
200	1.43	1.67	1.91	2.15	2.39	2.63	2.86	3.09	3.55	4.00	4.77	5.32	5.96	6.60	7.85	8.46
300	1.34	1.57	1.80	2.03	2.26	2.48	2.71	2.93	3.36	3.79	4.53	5.04	5.65	6.26	7.44	8.02
400	1.28	1.50	1.73	1.95	2.17	2.38	2.60	2.81	3.23	3.64	4.35	4.85	5.44	6.02	7.15	7.71
500	1.23	1.45	1.67	1.88	2.09	2.30	2.51	2.72	3.13	3.53	4.22	4.70	5.27	5.83	6.93	7.47
600	1.19	1.41	1.62	1.83	2.03	2.24	2.44	2.65	3.04	3.43	4.11	4.58	5.13	5.68	6.75	7.27
800	1.13	1.34	1.54	1.74	1.94	2.14	2.34	2.53	2.91	3.29	3.93	4.38	4.91	5.43	6.46	6.96
1000	1.08	1.28	1.48	1.67	1.87	2.06	2.25	2.44	2.81	3.17	3.79	4.23	4.74	5.25	6.23	6.71
1200	1.04	1.24	1.43	1.62	1.81	2.00	2.18	2.36	2.72	3.08	3.68	4.10	4.60	5.09	6.05	6.51
1400	1.01	1.20	1.39	1.57	1.76	1.94	2.12	2.30	2.65	3.00	3.59	4.00	4.48	4.96	5.89	6.34
1600	0.98	1.17	1.35	1.53	1.72	1.89	2.07	2.25	2.59	2.93	3.51	3.91	4.38	4.85	5.75	6.19
1800	0.95	1.14	1.32	1.50	1.68	1.85	2.03	2.20	2.54	2.87	3.43	3.83	4.29	4.75	5.63	6.06
2000	0.93	1.11	1.29	1.47	1.64	1.82	1.99	2.16	2.49	2.81	3.37	3.75	4.21	4.65	5.52	5.94
2400	0.89	1.07	1.24	1.41	1.58	1.75	1.92	2.08	2.40	2.72	3.25	3.63	4.07	4.50	5.33	5.73
2800	0.86	1.03	1.20	1.37	1.53	1.70	1.86	2.02	2.33	2.64	3.16	3.52	3.94	4.36	5.16	5.55
3200	0.83	1.00	1.16	1.33	1.49	1.65	1.81	1.96	2.27	2.57	3.07	3.43	3.84	4.24	5.01	5.39
3600	0.80	0.97	1.13	1.29	1.45	1.61	1.76	1.91	2.21	2.50	3.00	3.34	3.74	4.13	4.88	5.24
4000	0.78	0.94	1.10	1.26	1.42	1.57	1.72	1.87	2.16	2.45	2.93	3.26	3.65	4.03	4.76	5.10
5000	0.73	0.89	1.04	1.19	1.34	1.49	1.63	1.78	2.05	2.33	2.78	3.10	3.46	3.81	4.48	4.80
6000	0.69	0.84	0.99	1.14	1.28	1.42	1.56	1.70	1.96	2.22	2.66	2.95	3.30	3.62	4.23	4.52
8000	0.63	0.77	0.91	1.05	1.18	1.31	1.44	1.57	1.82	2.05	2.45	2.71	3.01	3.29	3.78	4.00
10000	0.57	0.71	0.84	0.97	1.10	1.23	1.35	1.47	1.69	1.91	2.26	2.49	2.75	2.97		
12000	0.53	0.66	0.79	0.91	1.03	1.15	1.26	1.37	1.58	1.78	2.09	2.29				
14000	0.50	0.62	0.74	0.86	0.97	1.08	1.19	1.29	1.48	1.66	1.93					

Length Correction Factor		0.70	0.75	0.80	0.85	0.90	0.95	1.00	1.05	1.10	1.15	1.20	1.25	1.30	1.35	1.40	
For Belt Length	From	Length (mm)	120	129	153	180	213	252	294	348	408	480	567	666	786	924	1092
		# of teeth	40	43	51	60	71	84	98	116	136	160	189	222	262	308	364
	To	Length (mm)	126	150	177	210	249	291	345	405	477	564	663	783	921	1089	1200
		# of teeth	42	50	59	70	83	97	115	135	159	188	221	261	307	363	400

Shaded area indicates drive conditions where reduced service life can be expected. Contact Gates Product Application Engineering for specific recommendations.



# PowerGrip® GT®3 Belt Drives

## Belt Width Selection Tables – 5mm PowerGrip® GT®3 Belts

The following table represents the torque ratings for each belt in its base width at the predetermined number of grooves, pitch diameters and rpm. These ratings must be multiplied by the appropriate width factor and applicable belt length factor to obtain the corrected torque rating. (See Step 4 of Drive Selection Procedure on Page 12.)

<b>Belt Width (mm)</b>	9	15	20	25
<b>Width Multiplier</b>	0.54	1.00	1.40	1.82

### 5MGT Rated Torque (lb-in) For Small Sprocket - 15mm Belt Width\*

Number of Grooves	18	20	22	24	26	28	30	32	34	36	40	44	48	52	56	60	64	68	72	80
<b>Pitch (mm)</b>	28.65	31.82	35.02	38.20	41.37	44.55	47.75	50.92	54.10	57.30	63.65	70.02	76.40	82.75	89.12	95.50	101.85	108.22	114.57	127.33
<b>Diameter (in)</b>	<b>1.128</b>	<b>1.253</b>	<b>1.379</b>	<b>1.504</b>	<b>1.629</b>	<b>1.754</b>	<b>1.880</b>	<b>2.005</b>	<b>2.130</b>	<b>2.256</b>	<b>2.506</b>	<b>2.757</b>	<b>3.008</b>	<b>3.258</b>	<b>3.509</b>	<b>3.760</b>	<b>4.010</b>	<b>4.261</b>	<b>4.511</b>	<b>5.013</b>
10	101.5	120.8	140.1	159.2	178.2	197.1	216.1	234.8	253.5	272.2	309.2	346.1	382.8	419.2	455.6	491.7	527.6	563.5	599.1	670.2
20	94.36	112.9	131.4	149.7	167.9	186.0	204.1	222.1	239.9	257.9	293.3	328.6	363.8	398.5	433.3	467.9	502.2	536.5	570.5	638.4
40	87.21	104.9	122.7	140.1	157.5	174.8	192.2	209.4	226.4	243.6	277.4	311.1	344.7	377.9	411.0	444.0	476.7	509.4	541.9	606.6
60	83.02	100.3	117.5	134.6	151.5	168.3	185.2	201.9	218.5	235.2	268.1	300.9	333.5	365.8	398.0	430.1	461.9	493.6	525.1	588.0
100	77.75	94.41	111.1	127.5	143.9	160.1	176.4	192.5	208.6	224.7	256.4	288.0	319.4	350.6	381.6	412.5	443.1	473.7	504.0	564.6
200	70.59	86.46	102.3	118.0	133.5	149.0	164.5	179.8	195.1	210.3	240.5	270.5	300.4	329.9	359.3	388.6	417.6	446.6	475.4	532.7
300	66.40	81.81	97.22	112.4	127.5	142.5	157.5	172.4	187.1	202.0	231.2	260.3	289.2	317.8	346.3	374.6	402.7	430.8	458.6	514.1
400	63.43	78.51	93.58	108.4	123.2	137.9	152.6	167.1	181.5	196.0	224.6	253.0	281.2	309.2	337.0	364.7	392.1	419.5	446.7	500.8
500	61.13	75.94	90.77	105.4	119.9	134.3	148.7	163.0	177.2	191.4	219.4	247.4	275.1	302.5	329.8	357.0	383.9	410.8	437.4	490.4
600	59.24	73.85	88.46	102.9	117.1	131.3	145.6	159.6	173.6	187.6	215.2	242.7	270.0	297.0	323.9	350.7	377.1	403.6	429.8	482.0
800	56.27	70.55	84.82	98.88	112.8	126.7	140.6	154.3	168.0	181.7	208.6	235.4	262.0	288.3	314.6	340.6	366.4	392.2	417.6	468.4
1000	53.96	67.98	82.00	95.80	109.5	123.1	136.8	150.2	163.6	177.0	203.4	229.7	255.8	281.6	307.3	332.8	358.0	383.2	408.1	457.8
1200	52.07	65.88	79.69	93.28	106.8	120.2	133.6	146.8	160.0	173.2	199.2	225.0	250.7	276.0	301.2	326.3	351.1	375.8	400.2	448.9
1400	50.47	64.11	77.73	91.14	104.4	117.7	130.9	144.0	156.9	170.0	195.6	221.1	246.3	271.2	296.1	320.7	345.1	369.4	393.4	441.2
1600	49.09	62.56	76.03	89.28	102.4	115.5	128.6	141.5	154.3	167.1	192.4	217.6	242.5	267.1	291.6	315.8	339.8	363.8	387.4	434.4
1800	47.86	61.20	74.53	87.64	100.7	113.6	126.5	139.3	151.9	164.6	189.6	214.5	239.1	263.3	287.5	311.5	335.1	358.7	382.0	428.2
2000	46.76	59.98	73.18	86.16	99.05	111.8	124.6	137.3	149.8	162.4	187.1	211.7	236.0	260.0	283.8	307.5	330.8	354.0	377.0	422.5
2400	44.86	57.86	70.83	83.60	96.26	108.8	121.4	133.8	146.1	158.4	182.7	206.7	230.5	254.0	277.3	300.3	323.1	345.7	368.0	412.1
2800	43.24	56.05	68.84	81.41	93.88	106.3	118.6	130.8	142.9	155.0	178.8	202.4	225.8	248.7	271.5	294.0	316.2	338.2	359.9	402.7
3200	41.83	54.48	67.10	79.50	91.80	104.0	116.2	128.2	140.1	152.0	175.4	198.6	221.5	244.0	266.3	288.3	309.9	331.3	352.4	393.8
3600	40.58	53.08	65.54	77.79	89.93	102.0	114.0	125.8	137.6	149.3	172.3	195.1	217.6	239.6	261.4	282.9	304.0	324.8	345.2	385.3
4000	39.45	51.81	64.14	76.25	88.24	100.1	112.0	123.7	135.2	146.8	169.5	191.9	213.9	235.5	256.8	277.8	298.3	318.5	338.3	376.9
5000	37.03	49.09	61.11	72.90	84.56	96.10	107.6	118.9	130.1	141.3	163.1	184.5	205.5	226.0	246.1	265.7	284.8	303.5	321.6	
6000	35.00	46.80	58.55	70.05	81.41	92.63	103.8	114.8	125.6	136.3	157.3	177.8	197.8	217.1	235.9	254.1	271.7			
8000	31.67	43.00	54.24	65.22	76.01	86.63	97.15	107.4	117.5	127.5	146.7	165.2	182.9							
10000	28.89	39.80	50.57	61.03	71.27	81.28	91.13	100.7	110.0											
12000	26.43	36.92	47.21	57.15	66.81	76.18	85.33	94.09												
14000	24.2	34.22	44.02	53.42	62.46	71.15														

### Rated Torque (N-m)\*

10	11.5	13.7	15.8	18.0	20.1	22.3	24.4	26.5	28.6	30.8	34.9	39.1	43.3	47.4	51.5	55.6	59.6	63.7	67.7	75.7
20	10.7	12.8	14.8	16.9	19.0	21.0	23.1	25.1	27.1	29.1	33.1	37.1	41.1	45.0	49.0	52.9	56.7	60.6	64.5	72.1
40	9.85	11.9	13.9	15.8	17.8	19.8	21.7	23.7	25.6	27.5	31.3	35.2	38.9	42.7	46.4	50.2	53.9	57.6	61.2	68.5
60	9.38	11.3	13.3	15.2	17.1	19.0	20.9	22.8	24.7	26.6	30.3	34.0	37.7	41.3	45.0	48.6	52.2	55.8	59.3	66.4
100	8.78	10.7	12.6	14.4	16.3	18.1	19.9	21.8	23.6	25.4	29.0	32.5	36.1	39.6	43.1	46.6	50.1	53.5	56.9	63.8
200	7.98	9.77	11.6	13.3	15.1	16.8	18.6	20.3	22.0	23.8	27.2	30.6	33.9	37.3	40.6	43.9	47.2	50.5	53.7	60.2
300	7.50	9.24	11.0	12.7	14.4	16.1	17.8	19.5	21.1	22.8	26.1	29.4	32.7	35.9	39.1	42.3	45.5	48.7	51.8	58.1
400	7.17	8.87	10.6	12.3	13.9	15.6	17.2	18.9	20.5	22.1	25.4	28.6	31.8	34.9	38.1	41.2	44.3	47.4	50.5	56.6
500	6.91	8.58	10.3	11.9	13.5	15.2	16.8	18.4	20.0	21.6	24.8	27.9	31.1	34.2	37.3	40.3	43.4	46.4	49.4	55.4
600	6.69	8.34	9.99	11.6	13.2	14.8	16.4	18.0	19.6	21.2	24.3	27.4	30.5	33.6	36.6	39.6	42.6	45.6	48.6	54.5
800	6.36	7.97	9.58	11.2	12.7	14.3	15.9	17.4	19.0	20.5	23.6	26.6	29.6	32.6	35.5	38.5	41.4	44.3	47.2	52.9
1000	6.10	7.68	9.26	10.8	12.4	13.9	15.5	17.0	18.5	20.0	23.0	26.0	28.9	31.8	34.7	37.6	40.5	43.3	46.1	51.7
1200	5.88	7.44	9.00	10.5	12.1	13.6	15.1	16.6	18.1	19.6	22.5	25.4	28.3	31.2	34.0	36.9	39.7	42.5	45.2	50.7
1400	5.70	7.24	8.78	10.3	11.8	13.3	14.8	16.3	17.7	19.2	22.1	25.0	27.8	30.6	33.5	36.2	39.0	41.7	44.5	49.9
1600	5.55	7.07	8.59	10.1	11.6	13.0	14.5	16.0	17.4	18.9	21.7	24.6	27.4	30.2	32.9	35.7	38.4	41.1	43.8	49.1
1800	5.41	6.91	8.42	9.90	11.4	12.8	14.3	15.7	17.2	18.6	21.4	24.2	27.0	29.8	32.5	35.2	37.9	40.5	43.2	48.4
2000	5.28	6.78	8.27	9.74	11.2	12.6	14.1	15.5	16.9	18.3	21.1	23.9	26.7	29.4	32.1	34.7	37.4	40.0	42.6	47.7
2400	5.07	6.54	8.00	9.45	10.9	12.3	13.7	15.1	16.5	17.9	20.6	23.4	26.0	28.7	31.3	33.9	36.5	39.1	41.6	46.6
2800	4.89	6.33	7.78	9.20	10.6	12.0	13.4	14.8	16.1	17.5	20.2	22.9	25.5	28.1	30.7	33.2	35.7	38.2	40.7	45.5
3200	4.73	6.15	7.58	8.98	10.4	11.7	13.1	14.5	15.8	17.2	19.8	22.4	25.0	27.6	30.1	32.6	35.0	37.4	39.8	44.5
3600	4.58	6.00	7.41	8.79	10.2	11.5	12.9	14.2	15.5	16.9	19.5	22.0	24.6	27.1	29.5	32.0	34.3	36.7	39.0	43.5
4000	4.46	5.85	7.25	8.62	9.97	11.3	12.7	14.0	15.3	16.6	19.1	21.7	24.2	26.6	29.0	31.4	33.7	36.0	38.2	

# PowerGrip® GT®3 Belt Drives

## Belt Width Selection Tables – 5mm PowerGrip® GT®3 Belts

The following table represents the torque ratings for each belt in its base width at the predetermined number of grooves, pitch diameters and rpm. These ratings must be multiplied by the appropriate width factor and applicable belt length factor to obtain the corrected torque rating. (See Step 4 of Drive Selection Procedure on Page 12.)

<b>Belt Width (mm)</b>	9	15	20	25
<b>Width Multiplier</b>	0.54	1.00	1.40	1.82

### 5MGT Rated Horsepower for Small Sprocket - 15mm Belt Width\*

Number of Grooves	18	20	22	24	26	28	30	32	34	36	40	44	48	52	56	60	64	68	72	80
<b>Pitch (mm)</b>	28.65	31.82	35.02	38.20	41.37	44.55	47.75	50.92	54.10	57.30	63.65	70.02	76.40	82.75	89.12	95.50	101.85	108.22	114.57	127.33
<b>Diameter (in)</b>	<b>1.128</b>	<b>1.253</b>	<b>1.379</b>	<b>1.504</b>	<b>1.629</b>	<b>1.754</b>	<b>1.880</b>	<b>2.005</b>	<b>2.130</b>	<b>2.256</b>	<b>2.506</b>	<b>2.757</b>	<b>3.008</b>	<b>3.258</b>	<b>3.509</b>	<b>3.760</b>	<b>4.010</b>	<b>4.261</b>	<b>4.511</b>	<b>5.013</b>
10	0.02	0.02	0.02	0.03	0.03	0.03	0.03	0.04	0.04	0.04	0.05	0.05	0.06	0.07	0.07	0.08	0.08	0.09	0.10	0.11
20	0.03	0.04	0.04	0.05	0.05	0.06	0.06	0.07	0.08	0.08	0.09	0.10	0.12	0.13	0.14	0.15	0.16	0.17	0.18	0.20
40	0.06	0.07	0.08	0.09	0.10	0.11	0.12	0.13	0.14	0.15	0.18	0.20	0.22	0.24	0.26	0.28	0.30	0.32	0.34	0.39
60	0.08	0.10	0.11	0.13	0.14	0.16	0.18	0.19	0.21	0.22	0.26	0.29	0.32	0.35	0.38	0.41	0.44	0.47	0.50	0.56
100	0.12	0.15	0.18	0.20	0.23	0.25	0.28	0.31	0.33	0.36	0.41	0.46	0.51	0.56	0.61	0.65	0.70	0.75	0.80	0.90
200	0.22	0.27	0.32	0.37	0.42	0.47	0.52	0.57	0.62	0.67	0.76	0.86	0.95	1.05	1.14	1.23	1.33	1.42	1.51	1.69
300	0.32	0.39	0.46	0.54	0.61	0.68	0.75	0.82	0.89	0.96	1.10	1.24	1.38	1.51	1.65	1.78	1.92	2.05	2.18	2.45
400	0.40	0.50	0.59	0.69	0.78	0.88	0.97	1.06	1.15	1.24	1.43	1.61	1.78	1.96	2.14	2.31	2.49	2.66	2.83	3.18
500	0.48	0.60	0.72	0.84	0.95	1.07	1.18	1.29	1.41	1.52	1.74	1.96	2.18	2.40	2.62	2.83	3.05	3.26	3.47	3.89
600	0.56	0.70	0.84	0.98	1.12	1.25	1.39	1.52	1.65	1.79	2.05	2.31	2.57	2.83	3.08	3.34	3.59	3.84	4.09	4.59
800	0.71	0.90	1.08	1.26	1.43	1.61	1.78	1.96	2.13	2.31	2.65	2.99	3.33	3.66	3.99	4.32	4.65	4.98	5.30	5.95
1000	0.86	1.08	1.30	1.52	1.74	1.95	2.17	2.38	2.60	2.81	3.23	3.65	4.06	4.47	4.88	5.28	5.68	6.08	6.48	7.26
1200	0.99	1.25	1.52	1.78	2.03	2.29	2.54	2.80	3.05	3.30	3.79	4.28	4.77	5.26	5.74	6.21	6.68	7.15	7.62	8.55
1400	1.12	1.42	1.73	2.02	2.32	2.61	2.91	3.20	3.49	3.78	4.34	4.91	5.47	6.03	6.58	7.12	7.67	8.21	8.74	9.80
1600	1.25	1.59	1.93	2.27	2.60	2.93	3.26	3.59	3.92	4.24	4.89	5.52	6.16	6.78	7.40	8.02	8.63	9.23	9.84	11.0
1800	1.37	1.75	2.13	2.50	2.87	3.24	3.61	3.98	4.34	4.70	5.42	6.13	6.83	7.52	8.21	8.90	9.57	10.2	10.91	12.2
2000	1.48	1.90	2.32	2.73	3.14	3.55	3.96	4.36	4.75	5.15	5.94	6.72	7.49	8.25	9.01	9.76	10.5	11.2	11.96	13.4
2400	1.71	2.20	2.70	3.18	3.67	4.14	4.62	5.09	5.56	6.03	6.96	7.87	8.78	9.67	10.6	11.4	12.3	13.2	14.01	15.7
2800	1.92	2.49	3.06	3.62	4.17	4.72	5.27	5.81	6.35	6.89	7.95	8.99	10.0	11.0	12.1	13.1	14.0	15.0	15.99	17.9
3200	2.12	2.77	3.41	4.04	4.66	5.28	5.90	6.51	7.11	7.72	8.91	10.1	11.2	12.4	13.5	14.6	15.7	16.8	17.89	20.0
3600	2.32	3.03	3.74	4.44	5.14	5.82	6.51	7.19	7.86	8.53	9.84	11.1	12.4	13.7	14.9	16.2	17.4	18.6	19.72	22.0
4000	2.50	3.29	4.07	4.84	5.60	6.35	7.11	7.85	8.58	9.32	10.8	12.2	13.6	14.9	16.3	17.6	18.9	20.2	21.47	23.9
5000	2.94	3.89	4.85	5.78	6.71	7.62	8.54	9.43	10.3	11.2	12.9	14.6	16.3	17.9	19.5	21.1	22.6	24.1		
6000	3.33	4.46	5.57	6.67	7.75	8.82	9.88	10.9	12.0	13.0	15.0	16.9	18.8	20.7	22.5	24.2	25.9			
8000	4.02	5.46	6.89	8.28	9.65	11.0	12.3	13.6	14.9	16.2	18.6	21.0	23.2							
10000	4.58	6.31	8.02	9.68	11.3	12.9	14.5	16.0	17.4	18.9										
12000	5.03	7.03	8.99	10.9	12.7	14.5	16.2	17.9												
14000	5.37	7.60	9.78	11.9	13.9	15.8														

### 5MGT Rated Kilowatts\*

10	0.01	0.01	0.02	0.02	0.02	0.02	0.03	0.03	0.03	0.03	0.04	0.04	0.05	0.05	0.06	0.06	0.07	0.07	0.08	0.08
20	0.02	0.03	0.03	0.04	0.04	0.04	0.05	0.05	0.06	0.06	0.07	0.08	0.09	0.10	0.11	0.12	0.13	0.15	0.16	0.18
40	0.04	0.05	0.06	0.07	0.07	0.08	0.09	0.10	0.11	0.12	0.13	0.15	0.16	0.18	0.21	0.24	0.26	0.28	0.31	0.33
60	0.06	0.07	0.08	0.10	0.11	0.12	0.13	0.14	0.16	0.17	0.19	0.21	0.24	0.26	0.28	0.31	0.33	0.35	0.37	0.42
100	0.09	0.11	0.13	0.15	0.17	0.19	0.21	0.23	0.25	0.27	0.30	0.34	0.38	0.41	0.45	0.49	0.52	0.56	0.60	0.67
200	0.17	0.20	0.24	0.28	0.32	0.35	0.39	0.43	0.46	0.50	0.57	0.64	0.71	0.78	0.85	0.92	0.99	1.06	1.12	1.26
300	0.24	0.29	0.35	0.40	0.45	0.51	0.56	0.61	0.66	0.72	0.82	0.92	1.03	1.13	1.23	1.33	1.43	1.53	1.63	1.82
400	0.30	0.37	0.44	0.51	0.58	0.65	0.72	0.79	0.86	0.93	1.06	1.20	1.33	1.46	1.60	1.73	1.86	1.99	2.11	2.37
500	0.36	0.45	0.54	0.62	0.71	0.79	0.88	0.96	1.05	1.13	1.30	1.46	1.63	1.79	1.95	2.11	2.27	2.43	2.59	2.90
600	0.42	0.52	0.63	0.73	0.83	0.93	1.03	1.13	1.23	1.33	1.53	1.72	1.92	2.11	2.30	2.49	2.68	2.87	3.05	3.42
800	0.53	0.67	0.80	0.94	1.07	1.20	1.33	1.46	1.59	1.72	1.97	2.23	2.48	2.73	2.98	3.22	3.47	3.71	3.95	4.43
1000	0.64	0.80	0.97	1.13	1.30	1.46	1.62	1.78	1.94	2.09	2.41	2.72	3.03	3.33	3.64	3.94	4.24	4.53	4.83	5.42
1200	0.74	0.94	1.13	1.32	1.52	1.71	1.90	2.08	2.27	2.46	2.83	3.20	3.56	3.92	4.28	4.63	4.98	5.34	5.68	6.37
1400	0.84	1.06	1.29	1.51	1.73	1.95	2.17	2.38	2.60	2.82	3.24	3.66	4.08	4.49	4.90	5.31	5.72	6.12	6.52	7.31
1600	0.93	1.18	1.44	1.69	1.94	2.19	2.43	2.68	2.92	3.16	3.64	4.12	4.59	5.06	5.52	5.98	6.43	6.89	7.33	8.22
1800	1.02	1.30	1.59	1.87	2.14	2.42	2.69	2.97	3.24	3.51	4.04	4.57	5.09	5.61	6.12	6.63	7.14	7.64	8.14	9.12
2000	1.11	1.42	1.73	2.04	2.34	2.65	2.95	3.25	3.55	3.84	4.43	5.01	5.58	6.15	6.72	7.28	7.83	8.38	8.92	10.0
2400	1.27	1.64	2.01	2.37	2.73	3.09	3.45	3.80	4.15	4.50	5.19	5.87	6.55	7.21	7.87	8.53	9.17	9.82	10.4	11.7
2800	1.43	1.86	2.28	2.70	3.11	3.52	3.93	4.33	4.73	5.14	5.92	6.71	7.48	8.24	8.99	9.74	10.5	11.2	11.9	13.3
3200	1.58	2.06	2.54	3.01	3.48	3.94	4.40	4.85	5.30	5.76	6.64	7.52	8.39	9.24	10.1	10.9	11.7	12.5	13.3	14.9
3600	1.73	2.26	2.79	3.31	3.83	4.34	4.86	5.36	5.86	6.36	7.34	8.31	9.27	10.2	11.1	12.0	12.9	13.8	14.7	16.4
4000	1.87	2.45	3.04	3.61	4.18	4.74	5.30	5.85	6.40	6.95	8.02	9.08	10.1	11.1	12.2	13.1	14.1	15.1	16.0	17.8
5000	2.19	2.90	3.62	4.31	5.00	5.69	6.37	7.03	7.70	8.36	9.65	10.9	12.2	13.4	14.6	15.7	16.8	18.0		
6000	2.48	3.32	4.16	4.97	5.78	6.58	7.37	8.15	8.91	9.68	11.2	12.6	14.0	15.4	16.7	18.0	19.3			
8000	3.00	4.07	5.13	6.17	7.19	8.20	9.20	1												



## Twin Power Belt Drive Systems

### Belt Construction

Gates Twin Power Belts have teeth on both sides to provide synchronization from both driving surfaces. This special feature makes possible unique drive designs such as multipoint drives, rotation reversal with one belt, serpentine drives, etc. It may also provide solutions to other difficult design problems.

Twin Power Belts are similar in construction to standard synchronous belts, including nylon-faced teeth on both sides. This construction uses essentially the same design parameters as standard synchronous belts. Gates 3mm and 5mm pitch Twin Power PowerGrip® GT®2 belts have helically-wound fiberglass tension members embedded in a Neoprene body with the belt teeth faced with a tough wear-resistant nylon fabric. A unique feature of this construction is that Gates Twin Power belts can transmit their full rated load on either the front or back side.

As shown below, three principal dimensions of a belt (Pitch, Pitch Length and Width) in millimeters are used to specify a Twin Power PowerGrip® GT®2 belt:

TP	3MR	450	09
Twin Power	Pitch	Pitch Length	Width

Belt pitch is the distance in millimeters between two adjacent tooth centers as measured on the pitch line of the belt. Belt pitch length is the total length (circumference) in millimeters as measured along the pitch line. The theoretical pitch line of a GT belt lies within the tensile member.

PowerGrip® GT®2 drives have a higher load capacity than PowerGrip® HTD® and PowerGrip® Timing drives. They also feature equivalent or better backlash characteristics when compared to PowerGrip® Timing drives. These attributes make PowerGrip® GT®2 the drive of choice for today's design engineers.

PowerGrip® GT®2 belts must run in PowerGrip® GT®2 sprockets. PowerGrip® GT®2 belts are not compatible with PowerGrip® HTD® sprockets.

### Made-To-Order Twin Power Belts

Additional sizes of Twin Power PowerGrip® GT®2 Belts are available on a made-to-order basis in pitch lengths from 385mm (15.2 in) up to lengths as great as tooling is available. If a mold is not available for the desired pitch length, tooling will be required.

Belts in nonstandard widths are available on a made-to-order basis.

Contact Customer Service for all made-to-order belt needs.

#### 3M PowerGrip GT2 Twin Power – Reference Dimensions

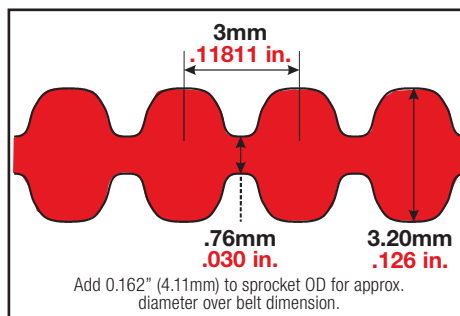

#### 5M PowerGrip GT2 Twin Power – Reference Dimensions

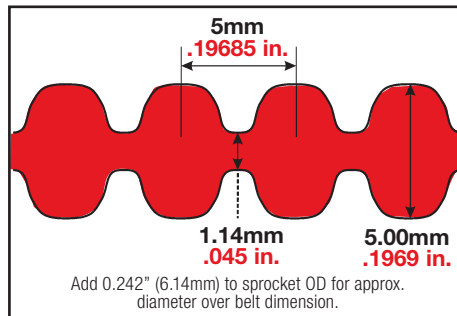

# PowerGrip® GT®2 Belt Drives – Twin Power – continued

## PowerGrip® GT®2 Belt Lengths and Widths

### 3mm Pitch Belt Lengths

Description	Pitch Length		No. of Teeth	Description	Pitch Length		No. of Teeth	Description	Pitch Length		No. of Teeth	Description	Pitch Length		No. of Teeth
	(mm)	(in)			(mm)	(in)			(mm)	(in)			(mm)	(in)	
TP3MR-372	372	14.646	124	TP3MR-483	483	19.016	161	TP3MR-630	630	24.803	210	TP3MR-891	891	35.079	297
TP3MR-375	375	14.764	125	TP3MR-486	486	19.134	162	TP3MR-633	633	24.921	211	TP3MR-900	900	35.433	300
TP3MR-381	381	15.000	127	TP3MR-489	489	19.252	163	TP3MR-639	639	25.157	213	TP3MR-915	915	36.024	305
TP3MR-384	384	15.118	128	TP3MR-492	492	19.370	164	TP3MR-645	645	25.394	215	TP3MR-945	945	37.205	315
TP3MR-387	387	15.236	129	TP3MR-501	501	19.724	167	TP3MR-648	648	25.512	216	TP3MR-951	951	37.441	317
TP3MR-390	390	15.354	130	TP3MR-504	504	19.843	168	TP3MR-654	654	25.748	218	TP3MR-981	981	38.622	327
TP3MR-393	393	15.472	131	TP3MR-510	510	20.079	170	TP3MR-657	657	25.866	219	TP3MR-1002	1002	39.449	334
TP3MR-396	396	15.591	132	TP3MR-513	513	20.197	171	TP3MR-663	663	26.102	221	TP3MR-1026	1026	40.394	342
TP3MR-399	399	15.709	133	TP3MR-519	519	20.433	173	TP3MR-669	669	26.339	223	TP3MR-1035	1035	40.748	345
TP3MR-405	405	15.945	135	TP3MR-525	525	20.669	175	TP3MR-684	684	26.929	228	TP3MR-1050	1050	41.339	350
TP3MR-411	411	16.181	137	TP3MR-528	528	20.787	176	TP3MR-687	687	27.047	229	TP3MR-1056	1056	41.575	352
TP3MR-414	414	16.299	138	TP3MR-531	531	20.906	177	TP3MR-696	696	27.402	232	TP3MR-1062	1062	41.811	354
TP3MR-417	417	16.417	139	TP3MR-537	537	21.142	179	TP3MR-711	711	27.992	237	TP3MR-1080	1080	42.520	360
TP3MR-420	420	16.535	140	TP3MR-552	552	21.732	184	TP3MR-735	735	28.937	245	TP3MR-1125	1125	44.291	375
TP3MR-426	426	16.772	142	TP3MR-558	558	21.969	186	TP3MR-738	738	29.055	246	TP3MR-1155	1155	45.472	385
TP3MR-432	432	17.008	144	TP3MR-564	564	22.205	188	TP3MR-750	750	29.528	250	TP3MR-1191	1191	46.890	397
TP3MR-435	435	17.126	145	TP3MR-570	570	22.441	190	TP3MR-753	753	29.646	251	TP3MR-1263	1263	49.724	421
TP3MR-438	438	17.244	146	TP3MR-576	576	22.677	192	TP3MR-786	786	30.945	262	TP3MR-1335	1335	52.559	445
TP3MR-444	444	17.480	148	TP3MR-585	585	23.031	195	TP3MR-795	795	31.299	265	TP3MR-1500	1500	59.055	500
TP3MR-447	447	17.598	149	TP3MR-591	591	23.268	197	TP3MR-822	822	32.362	274	TP3MR-1512	1512	59.528	504
TP3MR-459	459	18.071	153	TP3MR-597	597	23.504	199	TP3MR-837	837	32.953	279	TP3MR-1536	1536	60.472	512
TP3MR-465	465	18.307	155	TP3MR-600	600	23.622	200	TP3MR-840	840	33.071	280	TP3MR-1587	1587	62.480	529
TP3MR-468	468	18.425	156	TP3MR-606	606	23.858	202	TP3MR-843	843	33.189	281	TP3MR-1956	1956	77.008	652
TP3MR-471	471	18.543	157	TP3MR-609	609	23.976	203	TP3MR-873	873	34.370	291	TP3MR-2004	2004	78.898	668
TP3MR-474	474	18.661	158	TP3MR-612	612	24.094	204	TP3MR-882	882	34.724	294	TP3MR-2061	2061	81.142	687
TP3MR-480	480	18.898	160	TP3MR-627	627	24.685	209								

All sizes are made to order. Contact Gates Customer Service for availability.

### 3mm Pitch Stock Belt Widths

Belt Width Code	Belt Width (mm)	Belt Width (in)
06	6	0.236
09	9	0.354
15	15	0.591

### 5mm Pitch Belt Lengths

Description	Pitch Length		No. of Teeth	Description	Pitch Length		No. of Teeth	Description	Pitch Length		No. of Teeth	Description	Pitch Length		No. of Teeth
	(mm)	(in)			(mm)	(in)			(mm)	(in)			(mm)	(in)	
TP5MR-400	400	15.748	80	TP5MR-765	765	30.118	153	TP5MR-1125	1125	44.291	225	TP5MR-1790	1790	70.472	358
TP5MR-405	405	15.945	81	TP5MR-790	790	31.102	158	TP5MR-1150	1150	45.276	230	TP5MR-1800	1800	70.866	360
TP5MR-425	425	16.732	85	TP5MR-800	800	31.496	160	TP5MR-1195	1195	47.047	239	TP5MR-1895	1895	74.606	379
TP5MR-450	450	17.717	90	TP5MR-815	815	32.087	163	TP5MR-1250	1250	49.213	250	TP5MR-1945	1945	76.575	389
TP5MR-500	500	19.685	100	TP5MR-830	830	32.677	166	TP5MR-1270	1270	50.000	254	TP5MR-1980	1980	77.953	396
TP5MR-535	535	21.063	107	TP5MR-835	835	32.874	167	TP5MR-1295	1295	50.984	259	TP5MR-2000	2000	78.740	400
TP5MR-565	565	22.244	113	TP5MR-850	850	33.465	170	TP5MR-1300	1300	51.181	260	TP5MR-2110	2110	83.071	422
TP5MR-575	575	22.638	115	TP5MR-870	870	34.252	174	TP5MR-1375	1375	54.134	275	TP5MR-2250	2250	88.583	450
TP5MR-580	580	22.835	116	TP5MR-890	890	35.039	178	TP5MR-1420	1420	55.906	284	TP5MR-2525	2525	99.409	505
TP5MR-600	600	23.622	120	TP5MR-900	900	35.433	180	TP5MR-1450	1450	57.087	290	TP5MR-2760	2760	108.661	552
TP5MR-625	625	24.606	125	TP5MR-925	925	36.417	185	TP5MR-1575	1575	62.008	315	TP5MR-3120	3120	122.835	624
TP5MR-650	650	25.591	130	TP5MR-950	950	37.402	190	TP5MR-1595	1595	62.795	319	TP5MR-3170	3170	124.803	634
TP5MR-700	700	27.559	140	TP5MR-975	975	38.386	195	TP5MR-1600	1600	62.992	320	TP5MR-3200	3200	125.984	640
TP5MR-710	710	27.953	142	TP5MR-985	985	38.780	197	TP5MR-1635	1635	64.370	327	TP5MR-3430	3430	135.039	686
TP5MR-740	740	29.134	148	TP5MR-1000	1000	39.370	200	TP5MR-1690	1690	66.535	338	TP5MR-3800	3800	149.606	760
TP5MR-745	745	29.331	149	TP5MR-1050	1050	41.339	210	TP5MR-1720	1720	67.717	344				
TP5MR-750	750	29.528	150	TP5MR-1115	1115	43.898	223	TP5MR-1755	1755	69.094	351				

All sizes are made to order. Contact Gates Customer Service for availability.

### 5mm Pitch Stock Belt Widths

Belt Width Code	Belt Width (mm)	Belt Width (in)
09	9	0.354
15	15	0.591
25	25	0.984



## Drive Selection Procedure – Twin Power

### Step 1. Determine design load.

Service factors between 1.5 and 2.0 are generally recommended when designing small pitch synchronous drives. Knowledge of drive loading characteristics should influence the actual value selected. A higher service factor should be selected for applications with high peak loads, high operating speeds, unusually severe operating conditions, etc. Lower service factors can be used when the loading is smooth, well defined, etc. and the reliability is less critical. Some designs may require service factors outside the 1.5 to 2.0 range, depending upon the nature of the application. Contact Gates Product Application Engineering for additional information.

Stall torque of the driveR, or peak torque of the driveN unit, may be part of the nameplate data. If not, calculate Torque (Q) by using the formulas below. Determine the design torque or design power load for each driveN component in the belt drive system.

$$Q \text{ (lb - in)} = \frac{63,025 \times \text{Shaft HP}}{\text{Shaft RPM,}}$$

$$Q \text{ (lb - in)} = 8.85 \times Q \text{ (N - m) or}$$

$$Q \text{ (oz - in)} = 16 \times Q \text{ (lb - in)}$$

$$\text{Peak Design Load} = \text{Load} \times \text{Service Factor}$$

Sum all design loads from each of the driveN components together for a total design load value.

**NOTE:** When performing drive calculations based upon torque loads, drive input/output power is constant but drive input/output torque is not. Drive input/output torque is a function of the speed ratio. Drive designs should be based upon the smaller, faster sprocket, at the torque load calculated for its operating speed. These critical drive parameters should be used for all engineering calculations. See engineering calculations on Page 103 for additional formulas and unit conversions.

### Step 2. Determine belt pitch and select sprockets.

- A. Select Belt Pitch by using the Belt Pitch Selection Guide on pages 25, 41 and 53.

- B. Determine the speed ratios by dividing the larger speed, Sprocket Pitch Diameter or Sprocket Groove Number by the lesser speed, Sprocket Pitch Diameter or Sprocket Groove Number.
- C. Refer to the appropriate Sprocket Diameter Tables on pages 29-31, pages 44-45 or page 53. Select sprockets based upon speed ratio and drive requirements. Use stock sprocket sizes whenever possible.
- D. Check the Belt Speed, V, of the smaller sprocket selected, using the following formula:

$$V \text{ (fpm)} = 0.262 \times \text{Sprocket PD (in)} \times \text{Sprocket RPM}$$

$$V \text{ (m/s)} = 0.0000524 \times \text{Sprocket PD (mm)} \times \text{Sprocket RPM and,}$$

$$\text{m/s} = 0.00508 \times \text{fpm}$$

**NOTE:** Belt speeds in excess of 6,500 fpm (33.02 m/s) require special sprocket materials and dynamic balancing.

### Step 3. Belt length in a multi-point or serpentine drive layout can be best determined using either graphical methods or computer software. For computer aided belt drive design assistance, contact Gates Product Application Engineering for assistance.

Using the calculated range of pitch lengths, select a belt of the proper length from the appropriate belt length table. Use a standard length as shown in the tables on pages 23, page 45 or 56, if possible.

### Step 4. Determine belt width.

Belt Width Selection Tables on pages 26-28, pages 42-43 and page 54 show the load ratings for the stock widths of each of the stock belt pitches. Locate the critical sprocket in the drive system. It may be the small drive sprocket, or it may be one of the larger driveN sprockets with less than 6 teeth in mesh. Using the critical sprocket groove number and rpm as determined in Step 2, locate a torque or horsepower rating in the Belt Width Selection Tables of the proper belt pitch nearest to, but greater than, the peak design load from Step 1 based upon the critical sprocket. Evaluate each individual driveN sprocket using the same procedure, but with the appropriate design load and speed. The critical

sprocket will yield the greatest belt width. The greatest belt width resulting from this process should be selected for the application.

**NOTE:** The torque or horsepower ratings are based on 6 or more teeth in mesh for the smaller sprocket. Calculate the teeth in mesh for the selected drive design using the Teeth In Mesh Formula on Page 104. If the teeth in mesh is less than 6, the drive must be de-rated as indicated, which may require redesign for additional drive capacity.

Torque or horsepower ratings for various belt widths can be calculated by multiplying the table rating by the appropriate belt width multiplier.

When designing with PowerGrip GT2 or HTD, use the belt length from Step 3 to find the proper belt length factor in the Length Factor Tables included with each Belt Width Selection table. Multiply the torque rating selected above by the belt length factor to obtain the corrected rating. For all designs, the torque or horsepower rating must be equal to, or greater than, the peak design load of Step 1, or the design load of the critical sprocket.

### Step 5. Determine proper belt installation tension.

Procedures to calculate proper belt installation tension for specific applications are included on Pages 65-66.

### Step 6. Check and specify drive components.

After the drive system components have been selected and checked against drive system requirements, contact Gates Product Application Engineering before going into production.

## Belt Pitch Selection Guide

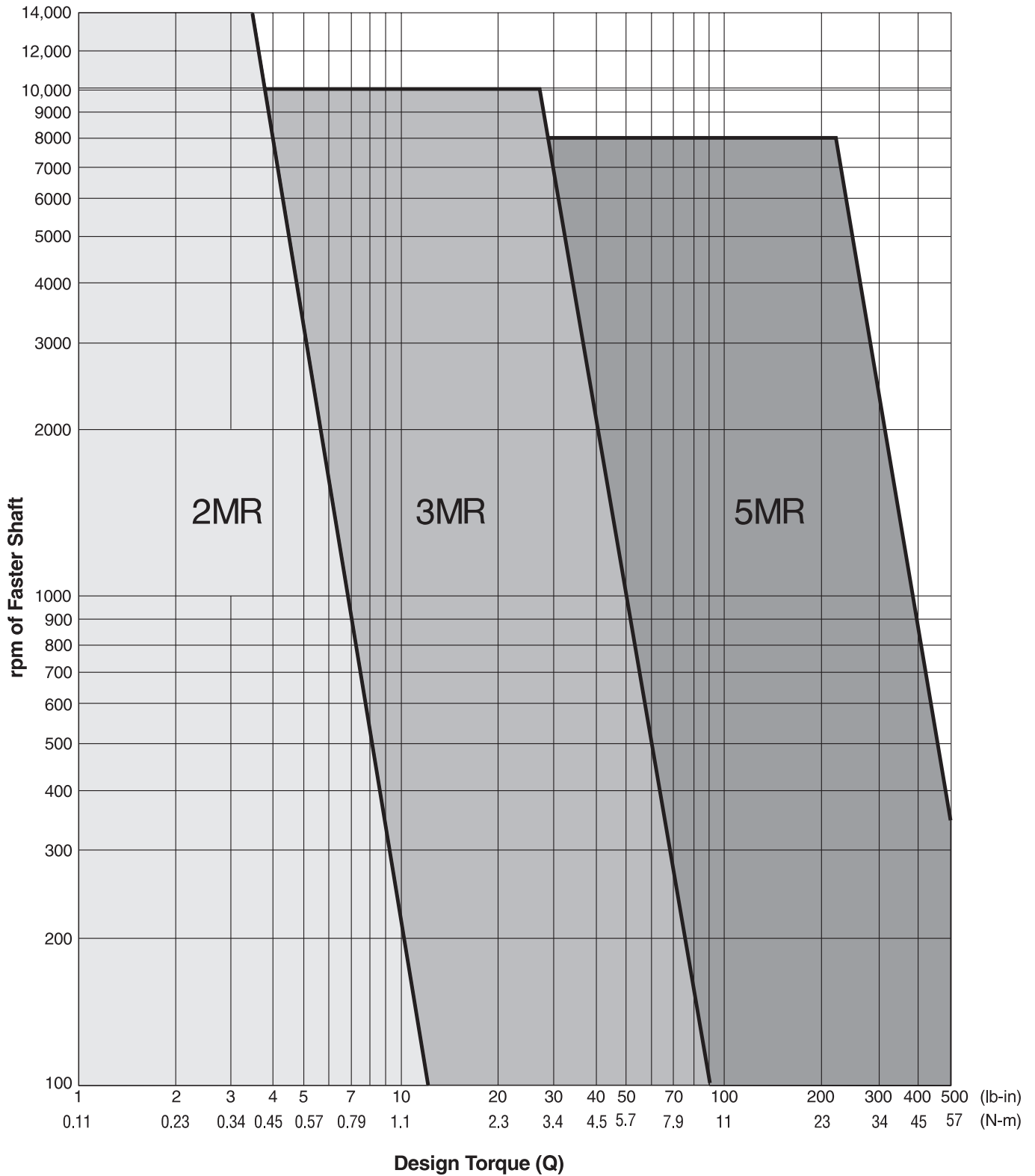

# PowerGrip® GT®2 Belt Drives – Twin Power

## Belt Width Selection Tables – 3mm PowerGrip® GT®2 Belts

The following table represents the torque ratings for each belt in its base width at the predetermined number of grooves, pitch diameters and rpm's. These ratings must be multiplied by the appropriate width factor and applicable belt length factor to obtain the corrected torque rating. (See Step 4 of Drive Selection Procedure on Page 24.)

Belt Width (mm)	6	9	12	15
Width Multiplier	1.00	1.50	2.00	2.50

### Rated Torque (lb-in) For Small Sprocket - 6mm Belt Width

Number of Grooves	16	18	20	22	24	28	30	34	38	45	50	56	62	74	80
Pitch (mm)	15.28	17.19	19.10	21.01	22.92	24.83	28.65	32.47	36.29	42.97	47.75	53.48	59.21	70.66	76.39
Diameter (in)	0.602	0.677	0.752	0.827	0.902	0.977	1.128	1.278	1.429	1.692	1.88	2.105	2.331	2.782	3.008
10	14.02	16.27	18.50	20.70	22.89	25.06	29.38	33.61	37.82	45.04	50.13	56.15	62.13	73.87	79.67
20	12.82	14.92	17.00	19.05	21.09	23.11	27.13	31.06	34.97	41.67	46.38	51.95	57.48	68.32	73.68
40	11.62	13.57	15.50	17.40	19.29	21.16	24.88	28.51	32.12	38.29	42.63	47.75	52.83	62.77	67.68
60	10.91	12.78	14.62	16.44	18.24	20.02	23.56	27.02	30.45	36.32	40.44	45.30	50.11	59.53	64.17
100	10.03	11.78	13.51	15.22	16.91	18.59	21.90	25.14	28.35	33.83	37.67	42.20	46.68	55.44	59.74
200	8.83	10.43	12.01	13.57	15.11	16.64	19.65	22.59	25.50	30.45	33.92	38.00	42.03	49.89	53.74
300	8.12	9.64	11.14	12.61	14.06	15.50	18.34	21.10	23.83	28.48	31.73	35.54	39.31	46.64	50.23
400	7.63	9.08	10.51	11.92	13.32	14.69	17.40	20.04	22.65	27.08	30.17	33.80	37.38	44.33	47.73
500	7.24	8.65	10.03	11.39	12.74	14.06	16.68	19.22	21.73	25.99	28.96	32.45	35.88	42.54	45.79
600	6.92	8.29	9.64	10.96	12.26	13.55	16.09	18.55	20.98	25.10	27.97	31.34	34.65	41.07	44.21
800	6.43	7.73	9.01	10.27	11.52	12.74	15.15	17.49	19.79	23.70	26.41	29.59	32.71	38.75	41.69
1000	6.04	7.30	8.53	9.74	10.94	12.11	14.43	16.67	18.87	22.60	25.20	28.23	31.20	36.94	39.73
1200	5.72	6.94	8.14	9.31	10.46	11.60	13.83	15.99	18.12	21.71	24.20	27.11	29.96	35.45	38.12
1400	5.46	6.64	7.80	8.94	10.06	11.16	13.33	15.42	17.48	20.95	23.36	26.16	28.91	34.19	36.74
1600	5.22	6.38	7.51	8.62	9.71	10.78	12.89	14.93	16.93	20.29	22.62	25.34	27.99	33.08	35.54
1800	5.02	6.15	7.26	8.34	9.40	10.45	12.51	14.49	16.44	19.71	21.97	24.60	27.17	32.09	34.46
2000	4.84	5.94	7.03	8.09	9.13	10.15	12.16	14.10	16.00	19.19	21.39	23.94	26.44	31.20	33.49
2400	4.52	5.59	6.63	7.65	8.65	9.64	11.56	13.42	15.23	18.27	20.37	22.79	25.15	29.63	31.77
2800	4.25	5.28	6.29	7.28	8.25	9.20	11.05	12.84	14.58	17.49	19.49	21.80	24.04	28.26	30.27
3200	4.02	5.02	6.00	6.96	7.90	8.81	10.61	12.33	14.01	16.81	18.72	20.93	23.05	27.04	28.92
3600	3.81	4.79	5.74	6.67	7.58	8.48	10.22	11.88	13.50	16.20	18.03	20.14	22.16	25.92	27.68
4000	3.63	4.58	5.51	6.42	7.30	8.17	9.86	11.48	13.04	15.64	17.40	19.41	21.34	24.89	26.52
5000	3.24	4.14	5.02	5.87	6.71	7.52	9.10	10.60	12.05	14.42	16.02	17.81	19.50	22.52	23.86
6000	2.91	3.77	4.61	5.42	6.21	6.98	8.46	9.86	11.20	13.38	14.81	16.40	17.87	20.36	21.39
8000	2.40	3.19	3.95	4.69	5.40	6.09	7.41	8.63	9.77	11.57	12.70	13.89	14.88	16.27	16.64
10000	1.99	2.72	3.42	4.10	4.74	5.36	6.53	7.59	8.55	9.97	10.79	11.54	12.03		
12000	1.64	2.32	2.97	3.59	4.17	4.73	5.75	6.64	7.41	8.45	8.93				
14000	1.34	1.98	2.57	3.13	3.66	4.15	5.03	5.75	6.33	6.95					

### Rated Torque (N-m)

10	1.58	1.84	2.09	2.34	2.59	2.83	3.32	3.80	4.27	5.09	5.66	6.34	7.02	8.35	9.00
20	1.45	1.69	1.92	2.15	2.38	2.61	3.06	3.51	3.95	4.71	5.24	5.87	6.49	7.72	8.32
40	1.31	1.53	1.75	1.97	2.18	2.39	2.81	3.22	3.63	4.33	4.82	5.40	5.97	7.09	7.65
60	1.23	1.44	1.65	1.86	2.06	2.26	2.66	3.05	3.44	4.10	4.57	5.12	5.66	6.73	7.25
100	1.13	1.33	1.53	1.72	1.91	2.10	2.47	2.84	3.20	3.82	4.26	4.77	5.27	6.26	6.75
200	1.00	1.18	1.36	1.53	1.71	1.88	2.22	2.55	2.88	3.44	3.83	4.29	4.75	5.64	6.07
300	0.92	1.09	1.26	1.42	1.59	1.75	2.07	2.38	2.69	3.22	3.58	4.02	4.44	5.27	5.68
400	0.86	1.03	1.19	1.35	1.50	1.66	1.97	2.26	2.56	3.06	3.41	3.82	4.22	5.01	5.39
500	0.82	0.98	1.13	1.29	1.44	1.59	1.88	2.17	2.45	2.94	3.27	3.67	4.05	4.81	5.17
600	0.78	0.94	1.09	1.24	1.39	1.53	1.82	2.10	2.37	2.84	3.16	3.54	3.92	4.64	4.99
800	0.73	0.87	1.02	1.16	1.30	1.44	1.71	1.98	2.24	2.68	2.98	3.34	3.70	4.38	4.71
1000	0.68	0.82	0.96	1.10	1.24	1.37	1.63	1.88	2.13	2.55	2.85	3.19	3.53	4.17	4.49
1200	0.65	0.78	0.92	1.05	1.18	1.31	1.56	1.81	2.05	2.45	2.73	3.06	3.39	4.01	4.31
1400	0.62	0.75	0.88	1.01	1.14	1.26	1.51	1.74	1.97	2.37	2.64	2.96	3.27	3.86	4.15
1600	0.59	0.72	0.85	0.97	1.10	1.22	1.46	1.69	1.91	2.29	2.56	2.86	3.16	3.74	4.02
1800	0.57	0.69	0.82	0.94	1.06	1.18	1.41	1.64	1.86	2.23	2.48	2.78	3.07	3.63	3.89
2000	0.55	0.67	0.79	0.91	1.03	1.15	1.37	1.59	1.81	2.17	2.42	2.71	2.99	3.53	3.78
2400	0.51	0.63	0.75	0.86	0.98	1.09	1.31	1.52	1.72	2.06	2.30	2.58	2.84	3.35	3.59
2800	0.48	0.60	0.71	0.82	0.93	1.04	1.25	1.45	1.65	1.98	2.20	2.46	2.72	3.19	3.42
3200	0.45	0.57	0.68	0.79	0.89	1.00	1.20	1.39	1.58	1.90	2.12	2.36	2.60	3.06	3.27
3600	0.43	0.54	0.65	0.75	0.86	0.96	1.15	1.34	1.53	1.83	2.04	2.28	2.50	2.93	3.13
4000	0.41	0.52	0.62	0.73	0.83	0.92	1.11	1.30	1.47	1.77	1.97	2.19	2.41	2.81	3.00
5000	0.37	0.47	0.57	0.66	0.76	0.85	1.03	1.20	1.36	1.63	1.81	2.01	2.20	2.55	2.70
6000	0.33	0.43	0.52	0.61	0.70	0.79	0.96	1.11	1.27	1.51	1.67	1.85	2.02	2.30	2.42
8000	0.27	0.36	0.45	0.53	0.61	0.69	0.84	0.97	1.10	1.31	1.44	1.57	1.68	1.84	1.88
10000	0.22	0.31	0.39	0.46	0.54	0.61	0.74	0.86	0.97	1.13	1.22	1.30	1.36		
12000	0.19	0.26	0.34	0.41	0.47	0.53	0.65	0.75	0.84	0.95	1.01				
14000	0.15	0.22	0.29	0.35	0.41	0.47	0.57	0.65	0.72	0.79					

Length Correction Factor		0.70	0.75	0.80	0.85	0.90	0.95	1.00	1.05	1.10	1.15	1.20	1.25	1.30	1.35	1.40	
For Belt Length	From	Length (mm)	120	129	153	180	213	252	294	348	408	480	567	666	786	924	1092
		# of teeth	40	43	51	60	71	84	98	116	136	160	189	222	262	308	364
	To	Length (mm)	126	150	177	210	249	291	345	405	477	564	663	783	921	1089	1200
		# of teeth	42	50	59	70	83	97	115	135	159	188	221	261	307	363	400

Shaded area indicates drive conditions where reduced service life can be expected. Contact Gates Product Application Engineering for specific recommendations.





# PowerGrip® GT®2 Belt Drives – Twin Power

## Belt Width Selection Tables – 5mm PowerGrip® GT®2 Belts

The following table represents the torque ratings for each belt in its base width at the predetermined number of grooves, pitch diameters and rpm's. These ratings must be multiplied by the appropriate width factor and applicable belt length factor to obtain the corrected torque rating. (See Step 4 of Drive Selection Procedure on Page 24.)

Belt Width (mm)	9	15	20	25
Width Multiplier	0.60	1.00	1.33	1.67

### Rated Torque (lb-in) For Small Sprocket - 15mm Belt Width\*

Number of Grooves	18	20	22	24	26	28	32	36	40	45	50	56	62	74	80
Pitch Diameter (mm)	28.65	31.83	35.01	38.20	41.38	44.56	50.93	57.30	63.66	71.62	79.58	89.13	98.68	117.77	127.32
Pitch Diameter (in)	<b>1.128</b>	<b>1.253</b>	<b>1.379</b>	<b>1.504</b>	<b>1.629</b>	<b>1.754</b>	<b>2.005</b>	<b>2.256</b>	<b>2.506</b>	<b>2.820</b>	<b>3.133</b>	<b>3.509</b>	<b>3.885</b>	<b>4.637</b>	<b>5.013</b>
10	78.24	93.61	109.00	124.20	139.30	154.3	184.3	214.10	243.6	280.3	316.6	359.9	403.0	488.3	530.6
20	72.38	87.11	101.80	116.40	130.90	145.2	173.9	202.40	230.6	265.6	300.4	341.7	382.8	464.2	504.6
40	66.53	80.60	94.69	108.60	122.40	136.1	163.5	190.70	217.6	251.0	284.1	323.5	362.7	440.2	478.5
60	63.11	76.80	90.51	104.00	117.50	130.8	157.5	183.90	209.9	242.4	274.6	312.9	350.9	426.1	463.3
100	58.80	72.01	85.23	98.27	111.20	124.1	149.8	175.20	200.4	231.7	262.6	299.5	336.0	408.3	444.1
200	52.94	65.51	78.08	90.46	102.80	115.0	139.4	163.50	187.4	217.0	246.3	281.2	315.8	384.2	418.1
300	49.52	61.70	73.89	85.90	97.83	109.7	133.3	156.70	179.7	208.4	236.8	270.6	304.0	370.1	402.8
400	47.09	59.00	70.92	82.65	94.31	105.9	129.0	151.80	174.3	202.3	230.0	263.0	295.6	360.0	391.8
500	45.20	56.91	68.61	80.14	91.59	103.0	125.6	148.00	170.1	197.6	224.7	257.0	289.0	352.1	383.3
600	43.66	55.19	66.73	78.08	89.36	100.6	122.9	144.90	166.7	193.7	220.4	252.2	283.6	345.6	376.2
800	41.22	52.49	63.74	74.83	85.83	96.76	118.5	140.00	161.2	187.6	213.5	244.4	275.0	335.2	364.9
1000	39.33	50.38	61.43	72.30	83.09	93.80	115.1	136.20	156.9	182.7	208.1	238.3	268.2	326.9	355.9
1200	37.78	48.66	59.53	70.22	80.83	91.37	112.3	133.00	153.4	178.7	203.7	233.3	262.5	320.0	348.2
1400	36.47	47.20	57.92	68.46	78.92	89.31	109.9	130.30	150.4	175.3	199.8	228.9	257.6	313.8	341.4
1600	35.33	45.93	56.51	66.93	77.25	87.50	107.9	128.00	147.8	172.3	196.4	225.0	253.2	308.3	335.3
1800	34.32	44.80	55.27	65.57	75.77	85.90	106.0	125.90	145.4	169.6	193.3	221.5	249.1	303.2	329.6
2000	33.41	43.79	54.16	64.34	74.44	84.46	104.3	124.00	143.2	167.1	190.5	218.2	245.4	298.4	324.2
2400	31.84	42.03	52.20	62.20	72.10	81.92	101.4	120.60	139.4	162.7	185.4	212.3	238.6	289.5	314.1
2800	30.49	40.53	50.53	60.36	70.09	79.73	98.84	117.60	136.0	158.7	180.9	206.9	232.3	281.0	304.4
3200	29.31	39.20	49.06	58.73	68.31	77.79	96.54	115.00	132.9	155.1	176.6	201.8	226.3	272.8	294.9
3600	28.26	38.02	47.74	57.27	66.70	76.02	94.45	112.50	130.1	151.7	172.6	197.0	220.5	264.7	285.3
4000	27.31	36.94	46.53	55.93	65.21	74.39	92.50	110.20	127.4	148.4	168.8	192.3	214.8	256.5	275.7
5000	25.23	34.58	43.88	52.96	61.91	70.74	88.07	104.90	121.1	140.7	159.4	180.6	200.4	235.4	
6000	23.45	32.55	41.56	50.35	58.98	67.46	84.01	99.93	115.1	133.2	150.1	168.7	185.5		
8000	20.43	29.03	37.50	45.69	53.67	61.43	76.33	90.27	103.1	117.8	130.5				
10000	17.77	25.88	33.79	41.35	48.63	55.06	68.66	80.34							
12000	15.29	22.88	30.19	37.07	43.57	49.67	60.63								
14000	12.88	19.91	26.56	32.69	38.34	43.46									

### Rated Torque (N-m)\*

10	8.84	10.58	12.32	14.03	15.74	17.44	20.83	24.19	27.52	30.84	35.77	40.67	45.54	55.17	59.95
20	8.18	9.84	11.51	13.15	14.78	16.41	19.65	22.87	26.05	29.22	33.94	38.61	43.26	52.45	57.01
40	7.52	9.11	10.70	12.27	13.83	15.38	18.48	21.55	24.58	27.60	32.10	36.55	40.98	49.73	54.07
60	7.13	8.68	10.23	11.75	13.27	14.78	17.79	20.77	23.72	26.66	31.03	35.35	39.65	48.14	52.35
100	6.64	8.14	9.63	11.10	12.57	14.02	16.92	19.80	22.64	25.47	29.67	33.83	37.97	46.14	50.18
200	5.98	7.40	8.82	10.22	11.61	12.99	15.75	18.48	21.17	23.85	27.83	31.78	35.69	43.42	47.24
300	5.59	6.97	8.38	9.71	11.05	12.39	15.06	17.70	20.31	22.90	26.76	30.57	34.35	41.82	45.51
400	5.32	6.67	8.01	9.34	10.66	11.96	14.57	17.15	19.70	22.23	25.99	29.71	33.40	40.68	44.27
500	5.11	6.43	7.75	9.05	10.35	11.63	14.19	16.72	19.22	21.71	25.40	29.04	32.66	39.79	43.31
600	4.93	6.24	7.54	8.82	10.10	11.36	13.88	16.37	18.83	21.28	24.91	28.49	32.05	39.05	42.51
800	4.66	5.93	7.20	8.45	9.70	10.93	13.39	15.82	18.21	20.60	24.13	27.62	31.07	37.88	41.23
1000	4.44	5.69	6.94	8.17	9.39	10.60	13.01	15.39	17.73	20.06	23.52	26.93	30.30	36.94	40.21
1200	4.27	5.50	6.73	7.93	9.13	10.32	12.69	15.03	17.33	19.62	23.01	26.36	29.66	36.15	39.34
1400	4.12	5.33	6.54	7.73	8.92	10.09	12.42	14.73	16.99	19.24	22.58	25.86	29.10	35.46	38.58
1600	3.99	5.19	6.39	7.56	8.73	9.89	12.19	14.46	16.69	18.91	22.19	25.42	28.61	34.84	37.89
1800	3.88	5.06	6.24	7.41	8.56	9.71	11.98	14.22	16.43	18.61	21.85	25.02	28.15	34.26	37.24
2000	3.78	4.95	6.12	7.27	8.41	9.54	11.79	14.01	16.18	18.34	21.53	24.65	27.73	33.72	36.63
2400	3.60	4.75	5.90	7.03	8.15	9.26	11.46	13.62	15.75	17.85	20.95	23.98	26.96	32.71	35.49
2800	3.45	4.58	5.71	6.82	7.92	9.01	11.17	13.29	15.37	17.42	20.44	23.38	26.25	31.76	34.39
3200	3.31	4.43	5.54	6.64	7.72	8.79	10.91	12.99	15.02	17.02	19.96	22.80	25.57	30.83	33.32
3600	3.19	4.30	5.39	6.47	7.54	8.59	10.67	12.71	14.70	16.65	19.51	22.26	24.91	29.91	32.24
4000	3.09	4.17	5.26	6.32	7.37	8.41	10.45	12.45	14.40	16.30	19.07	21.72	24.27	28.99	31.15
5000	2.85	3.91	4.96	5.98	7.00	7.99	9.95	11.85	13.68	15.46	18.01	20.41	22.64	26.60	
6000	2.65	3.68	4.70	5.69	6.66	7.62	9.49	11.29	13.01	14.65	16.96	19.06	20.96		
8000	2.31	3.28	4.24	5.16	6.06	6.94	8.62	10.20	11.65	12.99	14.75				
10000	2.01	2.92	3.82	4.67	5.49	6.28	7.76	9.08							
12000	1.73	2.59	3.41	4.19	4.92	5.61	6.85								
14000	1.45	2.25	3.00	3.69	4.33	4.91									

Length Correction Factor		0.65	0.70	0.75	0.80	0.85	0.90	0.95	1.00	1.05	1.10	1.15	1.20	1.25	1.30	
For Belt Length	From	Length (mm)	200	215	260	315	375	450	540	650	780	935	1130	1355	1625	1960
		# of teeth	40	43	52	63	75	90	108	130	156	187	226	271	325	392
	To	Length (mm)	210	255	310	370	445	535	645	775	930	1125	1350	1620	1955	2000
		# of teeth	42	51	62	74	89	107	129	155	186	225	270	324	391	400

Shaded area indicates drive conditions where reduced service life can be expected. Contact Gates Product Application Engineering for specific recommendations.

\*See page 28 for hp or kw ratings.



# PowerGrip® GT®2 Belt Drives – Twin Power

## Belt Width Selection Tables – 5mm PowerGrip® GT®2 Belts

The following table represents the torque ratings for each belt in its base width at the predetermined number of grooves, pitch diameters and rpm. These ratings must be multiplied by the appropriate width factor and applicable belt length factor to obtain the corrected torque rating. (See Step 4 of Drive Selection Procedure on Page 24).

Belt Width (mm)	9	15	20	25
Width Multiplier	0.60	1.00	1.33	1.67

### Rated Horsepower For Small Sprocket - 15mm Belt Width\*

Number of Grooves	18	20	22	24	26	28	32	36	40	45	48	50	62	74	80
<b>Pitch Diameter (mm)</b>	28.65	31.83	35.01	38.20	41.38	44.56	50.93	57.30	63.66	71.62	76.39	79.58	98.68	117.77	127.32
<b>Pitch Diameter (in)</b>	<b>1.128</b>	<b>1.253</b>	<b>1.379</b>	<b>1.504</b>	<b>1.629</b>	<b>1.754</b>	<b>2.005</b>	<b>2.256</b>	<b>2.506</b>	<b>2.820</b>	<b>3.008</b>	<b>3.133</b>	<b>3.885</b>	<b>4.637</b>	<b>5.013</b>
10	0.01	0.01	0.02	0.02	0.02	0.02	0.03	0.03	0.04	0.04	0.05	0.05	0.06	0.08	0.08
20	0.02	0.03	0.03	0.04	0.04	0.05	0.06	0.06	0.07	0.08	0.09	0.10	0.12	0.15	0.16
40	0.04	0.05	0.06	0.07	0.08	0.09	0.10	0.12	0.14	0.16	0.17	0.18	0.23	0.28	0.30
60	0.06	0.07	0.09	0.10	0.11	0.12	0.15	0.18	0.20	0.23	0.25	0.26	0.33	0.41	0.44
100	0.09	0.11	0.14	0.16	0.18	0.20	0.24	0.28	0.32	0.37	0.40	0.42	0.53	0.65	0.70
200	0.17	0.21	0.25	0.29	0.33	0.36	0.44	0.52	0.59	0.69	0.74	0.78	1.00	1.22	1.33
300	0.24	0.29	0.35	0.41	0.47	0.52	0.63	0.75	0.86	0.99	1.07	1.13	1.45	1.76	1.92
400	0.30	0.37	0.45	0.52	0.60	0.67	0.82	0.96	1.11	1.28	1.39	1.46	1.88	2.28	2.49
500	0.36	0.45	0.54	0.64	0.73	0.82	1.00	1.17	1.35	1.57	1.70	1.78	2.29	2.79	3.04
600	0.42	0.53	0.64	0.74	0.85	0.96	1.17	1.38	1.59	1.84	2.00	2.10	2.70	3.29	3.58
800	0.52	0.67	0.81	0.95	1.09	1.23	1.50	1.78	2.05	2.38	2.58	2.71	3.49	4.26	4.63
1000	0.62	0.80	0.97	1.15	1.32	1.49	1.83	2.16	2.49	2.90	3.14	3.30	4.26	5.19	5.65
1200	0.72	0.93	1.13	1.34	1.54	1.74	2.14	2.53	2.92	3.40	3.69	3.88	5.00	6.09	6.63
1400	0.81	1.05	1.29	1.52	1.75	1.98	2.44	2.90	3.34	3.89	4.22	4.44	5.72	6.97	7.58
1600	0.90	1.17	1.43	1.70	1.96	2.22	2.74	3.25	3.75	4.37	4.74	4.99	6.43	7.83	8.51
1800	0.98	1.28	1.58	1.87	2.16	2.45	3.03	3.59	4.15	4.84	5.25	5.52	7.12	8.66	9.41
2000	1.06	1.39	1.72	2.04	2.36	2.68	3.31	3.93	4.55	5.30	5.75	6.05	7.79	9.47	10.29
2400	1.21	1.60	1.99	2.37	2.75	3.12	3.86	4.59	5.31	6.19	6.72	7.06	9.08	11.00	11.96
2800	1.35	1.80	2.24	2.68	3.11	3.54	4.39	5.23	6.04	7.05	7.64	8.04	10.30	12.50	13.52
3200	1.49	1.99	2.49	2.98	3.47	3.95	4.90	5.84	6.75	7.87	8.53	8.97	11.50	13.90	14.97
3600	1.61	2.17	2.73	3.27	3.81	4.34	5.40	6.43	7.43	8.66	9.39	9.86	12.60	15.10	16.30
4000	1.73	2.34	2.95	3.55	4.14	4.72	5.87	6.99	8.09	9.42	10.20	10.70	13.60	16.30	17.50
5000	2.00	2.74	3.48	4.20	4.91	5.61	6.99	8.32	9.61	11.2	12.06	12.60	15.90	18.70	
6000	2.23	3.10	3.96	4.79	5.62	6.42	8.00	9.51	10.96	12.7	13.66	14.30	17.70		
8000	2.59	3.69	4.76	5.80	6.81	7.80	9.69	11.46	13.09	14.9	15.95	16.60			
10000	2.82	4.11	5.36	6.56	7.72	8.82	10.89	12.75							
12000	2.91	4.36	5.75	7.06	8.30	9.46	11.54								
14000	2.86	4.42	5.90	7.26	8.52	9.65									

### Rated Kilowatts\*

10	0.01	0.01	0.01	0.01	0.02	0.02	0.02	0.03	0.03	0.03	0.04	0.04	0.05	0.06	0.06
20	0.02	0.02	0.02	0.03	0.03	0.03	0.04	0.05	0.05	0.06	0.07	0.07	0.09	0.11	0.12
40	0.03	0.04	0.04	0.05	0.06	0.06	0.08	0.09	0.10	0.12	0.13	0.13	0.17	0.21	0.23
60	0.04	0.05	0.06	0.07	0.08	0.09	0.11	0.13	0.15	0.17	0.19	0.19	0.25	0.30	0.33
100	0.07	0.09	0.10	0.12	0.13	0.15	0.18	0.21	0.24	0.27	0.30	0.31	0.40	0.48	0.53
200	0.13	0.16	0.18	0.21	0.24	0.27	0.33	0.39	0.44	0.51	0.56	0.58	0.75	0.91	0.99
300	0.18	0.22	0.26	0.30	0.35	0.39	0.47	0.56	0.64	0.74	0.80	0.84	1.08	1.31	1.43
400	0.22	0.28	0.34	0.39	0.45	0.50	0.61	0.72	0.83	0.96	1.04	1.09	1.40	1.70	1.85
500	0.27	0.34	0.41	0.47	0.54	0.61	0.74	0.88	1.01	1.17	1.27	1.33	1.71	2.08	2.27
600	0.31	0.39	0.47	0.55	0.63	0.71	0.87	1.03	1.18	1.38	1.49	1.56	2.01	2.45	2.67
800	0.39	0.50	0.60	0.71	0.81	0.92	1.12	1.33	1.53	1.78	1.92	2.02	2.60	3.17	3.45
1000	0.47	0.60	0.73	0.86	0.98	1.11	1.36	1.61	1.86	2.16	2.34	2.46	3.17	3.87	4.21
1200	0.54	0.69	0.85	1.00	1.15	1.30	1.59	1.89	2.18	2.54	2.75	2.89	3.73	4.54	4.94
1400	0.60	0.78	0.96	1.13	1.31	1.48	1.82	2.16	2.49	2.90	3.15	3.31	4.27	5.20	5.66
1600	0.67	0.87	1.07	1.27	1.46	1.66	2.04	2.42	2.80	3.26	3.54	3.72	4.79	5.84	6.35
1800	0.73	0.95	1.18	1.40	1.61	1.83	2.26	2.68	3.10	3.61	3.92	4.12	5.31	6.46	7.02
2000	0.79	1.04	1.28	1.52	1.76	2.00	2.47	2.93	3.39	3.95	4.29	4.51	5.81	7.06	7.67
2400	0.90	1.19	1.48	1.77	2.05	2.33	2.88	3.42	3.96	4.62	5.01	5.27	6.77	8.22	8.92
2800	1.01	1.34	1.67	2.00	2.32	2.64	3.27	3.90	4.51	5.26	5.70	5.99	7.70	9.31	10.08
3200	1.11	1.48	1.86	2.22	2.59	2.95	3.66	4.35	5.03	5.87	6.36	6.69	8.57	10.30	11.16
3600	1.20	1.62	2.03	2.44	2.84	3.24	4.02	4.79	5.54	6.46	7.00	7.35	9.39	11.30	12.15
4000	1.29	1.75	2.20	2.65	3.09	3.52	4.38	5.22	6.03	7.02	7.61	7.99	10.20	12.10	13.05
5000	1.49	2.05	2.60	3.13	3.66	4.18	5.21	6.21	7.16	8.32	9.00	9.43	11.90	13.90	
6000	1.67	2.31	2.95	3.57	4.19	4.79	5.96	7.09	8.17	9.45	10.19	10.70	13.20		
8000	1.93	2.75	3.55	4.32	5.08	5.81	7.23	8.54	9.76	11.10	11.89	12.4			
10000	2.10	3.06	4.00	4.89	5.75	6.58	8.12	9.51							
12000	2.17	3.25	4.29	5.26	6.19	7.05	8.61								
14000	2.13	3.30	4.40	5.42	6.35	7.20									

Length Correction Factor		0.65	0.70	0.75	0.80	0.85	0.90	0.95	1.00	1.05	1.10	1.15	1.20	1.25	1.30	
For Belt Length	From	Length (mm)	200	215	260	315	375	450	540	650	780	935	1130	1355	1625	1960
		# of teeth	40	43	52	63	75	90	108	130	156	187	226	271	325	392
	To	Length (mm)	210	255	310	370	445	535	645	775	930	1125	1350	1620	1955	2000
		# of teeth	42	51	62	74	89	107	129	155	186	225	270	324	391	400

Shaded area indicates drive conditions where reduced service life can be expected. Contact Gates Product Application Engineering for specific recommendations.

\*See page 27 for torque ratings.



# PowerGrip® GT®3 Belt Drives

## Sprocket Specification Tables – 2mm Pitch PowerGrip® GT®2 Sprockets

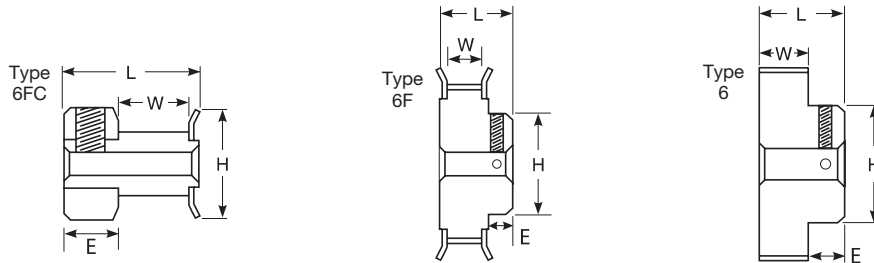

### 6mm (0.236 in) Wide Belts (2MGT-06)

Sprocket Number	No. of Grooves	Diameter (in)			Design Type	Dimensions (in)						Set Screws**	Wt. (lb)	Material***
		Pitch	OD	Flange Ref.		W	L	H	E	Plain Bore* (in)				
										Min	Max			
2MR-12S-06	12	0.301	0.281	0.480	6FC	0.290	0.562	0.480	0.235	0.125	0.125	4-40	0.01	AL
2MR-13S-06	13	0.326	0.306	0.505	6FC	0.290	0.562	0.505	0.235	0.125	0.125	4-40	0.01	AL
2MR-14S-06	14	0.351	0.331	0.530	6FC	0.290	0.562	0.530	0.235	0.125	0.125	4-40	0.01	AL
2MR-15S-06	15	0.376	0.356	0.555	6FC	0.290	0.562	0.555	0.235	0.188	0.188	6-40	0.01	AL
2MR-16S-06	16	0.401	0.381	0.580	6FC	0.290	0.562	0.580	0.235	0.188	0.250	6-40	0.01	AL
2MR-17S-06	17	0.426	0.406	0.635	6F	0.290	0.625	0.312	0.236	0.188	0.188	4-40	0.01	AL
2MR-18S-06	18	0.451	0.431	0.635	6F	0.290	0.625	0.312	0.236	0.188	0.188	4-40	0.01	AL
2MR-19S-06	19	0.476	0.456	0.635	6F	0.290	0.625	0.338	0.236	0.188	0.188	4-40	0.01	AL
2MR-20S-06	20	0.501	0.481	0.685	6F	0.290	0.625	0.364	0.236	0.188	0.188	4-40	0.01	AL
2MR-21S-06	21	0.526	0.506	0.710	6F	0.290	0.625	0.390	0.236	0.188	0.188	4-40	0.01	AL
2MR-22S-06	22	0.551	0.531	0.740	6F	0.290	0.625	0.390	0.236	0.188	0.188	4-40	0.01	AL
2MR-24S-06	24	0.602	0.582	0.790	6F	0.290	0.687	0.442	0.298	0.250	0.250	6-40	0.01	AL
2MR-25S-06	25	0.627	0.607	0.815	6F	0.290	0.687	0.468	0.298	0.250	0.250	6-40	0.01	AL
2MR-26S-06	26	0.652	0.632	0.840	6F	0.290	0.687	0.490	0.298	0.250	0.250	6-40	0.01	AL
2MR-28S-06	28	0.702	0.682	0.895	6F	0.290	0.687	0.494	0.298	0.250	0.250	6-40	0.02	AL
2MR-30S-06	30	0.752	0.732	0.945	6F	0.290	0.687	0.546	0.298	0.250	0.313	8-32	0.02	AL
2MR-32S-06	32	0.802	0.782	1.000	6F	0.290	0.687	0.598	0.298	0.250	0.375	8-32	0.02	AL
2MR-36S-06	36	0.902	0.882	1.105	6F	0.290	0.687	0.676	0.298	0.250	0.438	8-32	0.03	AL
2MR-40S-06	40	1.003	0.983	1.210	6F	0.290	0.719	0.754	0.314	0.250	0.500	8-32	0.04	AL
2MR-42S-06	42	1.053	1.033	1.260	6F	0.290	0.719	0.806	0.314	0.250	0.625	8-32	0.05	AL
2MR-44S-06	44	1.103	1.083	1.315	6F	0.290	0.719	0.858	0.314	0.250	0.688	8-32	0.05	AL
2MR-45S-06	45	1.128	1.108	1.340	6F	0.290	0.719	0.900	0.314	0.250	0.688	8-32	0.06	AL
2MR-48S-06	48	1.203	1.183	1.420	6F	0.290	0.719	0.936	0.314	0.250	0.688	8-32	0.07	AL
2MR-50S-06	50	1.253	1.233	1.470	6F	0.290	0.719	0.936	0.314	0.250	0.688	8-32	0.07	AL
2MR-56S-06	56	1.404	1.384	1.575	6F	0.290	0.719	1.030	0.314	0.250	0.813	8-32	0.08	AL
2MR-60S-06	60	1.504	1.484	1.730	6F	0.290	0.719	1.222	0.314	0.250	0.875	8-32	0.10	AL
2MR-60S-06	60	1.504	1.484	----	6	0.375	0.750	1.148	0.375	0.250	0.875	8-32	0.10	AL
2MR-62S-06	62	1.554	1.534	----	6	0.375	0.750	1.148	0.375	0.250	0.938	8-32	0.10	AL
2MR-68S-06	68	1.704	1.684	----	6	0.375	0.750	1.185	0.375	0.250	0.938	8-32	0.12	AL
2MR-72S-06	72	1.805	1.785	----	6	0.375	0.750	1.195	0.375	0.250	0.938	8-32	0.13	AL
2MR-74S-06	74	1.855	1.835	----	6	0.375	0.750	1.215	0.375	0.250	1.000	8-32	0.13	AL
2MR-80S-06	80	2.005	1.985	----	6	0.375	0.750	1.500	0.375	0.313	1.250	8-32	0.17	AL
2MR-90S-06	90	2.256	2.236	----	6	0.375	0.750	1.500	0.375	0.313	1.250	8-32	0.20	AL
2MR-100S-06	100	2.506	2.486	----	6	0.375	0.750	1.500	0.375	0.313	1.250	8-32	0.24	AL
2MR-120S-06	120	3.008	2.988	----	6	0.375	0.750	1.500	0.375	0.375	1.250	10-32	0.30	AL

\* Plain bore style stocked in smallest bore \*\* 12-16 Groove pulleys have 1 set screw, all others have 2 at 90 degrees \*\*\* Clear Anodize Finish

**NOTE:** See Synchronous Belt Drives – Sprocket Specifications section, Page 73, for a complete table of stock and non-stock sprocket diameters.

For non-standard designs contact Gates Made-To-Order Metals Team at (800)709-6001

# PowerGrip® GT®3 Belt Drives

## Sprocket Specification Tables – 2mm Pitch PowerGrip® GT®2 Sprockets - Continued

### 9mm (0.354 in) Wide Belts (2MGT-09)

Sprocket Number	No. of Grooves	Diameter (in)			Design Type	Dimensions (in)						Set Screws**	Wt. (lb)	Material***
		Pitch	OD	Flange Ref.		Plain Bore' (in)								
						W	L	H	E	Min	Max			
2MR-12S-09	12	0.301	0.281	0.480	6FC	0.410	0.687	0.480	0.234	0.125	0.125	4-40	0.01	AL
2MR-13S-09	13	0.326	0.306	0.505	6FC	0.410	0.687	0.505	0.234	0.125	0.125	4-40	0.01	AL
2MR-14S-09	14	0.351	0.331	0.530	6FC	0.410	0.687	0.530	0.234	0.125	0.125	4-40	0.01	AL
2MR-15S-09	15	0.376	0.356	0.555	6FC	0.410	0.687	0.555	0.234	0.188	0.188	6-40	0.01	AL
2MR-16S-09	16	0.401	0.381	0.580	6FC	0.410	0.687	0.580	0.234	0.188	0.188	6-40	0.01	AL
2MR-17S-09	17	0.426	0.406	0.635	6F	0.410	0.750	0.312	0.236	0.188	0.188	4-40	0.01	AL
2MR-18S-09	18	0.451	0.431	0.635	6F	0.410	0.750	0.312	0.236	0.188	0.188	4-40	0.01	AL
2MR-19S-09	19	0.476	0.456	0.635	6F	0.410	0.750	0.338	0.236	0.188	0.188	4-40	0.01	AL
2MR-20S-09	20	0.501	0.481	0.685	6F	0.410	0.750	0.364	0.236	0.188	0.188	4-40	0.01	AL
2MR-21S-09	21	0.526	0.506	0.710	6F	0.410	0.750	0.390	0.236	0.188	0.188	4-40	0.01	AL
2MR-22S-09	22	0.551	0.531	0.740	6F	0.410	0.750	0.390	0.236	0.188	0.188	4-40	0.02	AL
2MR-24S-09	24	0.602	0.582	0.790	6F	0.410	0.812	0.442	0.298	0.250	0.250	6-40	0.01	AL
2MR-25S-09	25	0.627	0.607	0.815	6F	0.410	0.812	0.468	0.298	0.250	0.250	6-40	0.02	AL
2MR-26S-09	26	0.652	0.632	0.840	6F	0.410	0.812	0.490	0.298	0.250	0.250	6-40	0.02	AL
2MR-28S-09	28	0.702	0.682	0.895	6F	0.410	0.812	0.494	0.298	0.250	0.250	6-40	0.02	AL
2MR-30S-09	30	0.752	0.732	0.945	6F	0.410	0.812	0.546	0.298	0.250	0.313	8-32	0.02	AL
2MR-32S-09	32	0.802	0.782	1.000	6F	0.410	0.812	0.598	0.298	0.250	0.375	8-32	0.03	AL
2MR-36S-09	36	0.902	0.882	1.105	6F	0.410	0.812	0.676	0.298	0.250	0.438	8-32	0.04	AL
2MR-40S-09	40	1.003	0.983	1.210	6F	0.410	0.843	0.754	0.313	0.250	0.500	8-32	0.05	AL
2MR-42S-09	42	1.053	1.033	1.260	6F	0.410	0.843	0.806	0.313	0.250	0.625	8-32	0.06	AL
2MR-44S-09	44	1.103	1.083	1.315	6F	0.410	0.843	0.858	0.313	0.250	0.688	8-32	0.06	AL
2MR-45S-09	45	1.128	1.108	1.340	6F	0.410	0.843	0.900	0.313	0.250	0.688	8-32	0.07	AL
2MR-48S-09	48	1.203	1.183	1.420	6F	0.410	0.843	0.936	0.313	0.250	0.688	8-32	0.08	AL
2MR-50S-09	50	1.253	1.233	1.470	6F	0.410	0.843	0.936	0.313	0.250	0.688	8-32	0.08	AL
2MR-56S-09	56	1.404	1.384	1.575	6F	0.410	0.843	1.030	0.313	0.250	0.813	8-32	0.10	AL
2MR-60S-09	60	1.504	1.484	1.730	6F	0.410	0.843	1.222	0.313	0.250	0.875	8-32	0.12	AL
2MR-60S-09	60	1.504	1.484	----	6	0.500	0.875	1.148	0.375	0.250	0.875	8-32	0.12	AL
2MR-62S-09	62	1.554	1.534	----	6	0.500	0.875	1.148	0.375	0.250	0.938	8-32	0.12	AL
2MR-68S-09	68	1.704	1.684	----	6	0.500	0.875	1.185	0.375	0.250	0.938	8-32	0.14	AL
2MR-72S-09	72	1.805	1.785	----	6	0.500	0.875	1.195	0.375	0.250	0.938	8-32	0.16	AL
2MR-74S-09	74	1.855	1.835	----	6	0.500	0.875	1.215	0.375	0.250	1.000	8-32	0.17	AL
2MR-80S-09	80	2.005	1.985	----	6	0.500	0.875	1.500	0.375	0.313	1.250	8-32	0.21	AL
2MR-90S-09	90	2.256	2.236	----	6	0.500	0.875	1.500	0.375	0.313	1.250	8-32	0.25	AL
2MR-100S-09	100	2.506	2.486	----	6	0.500	0.875	1.500	0.375	0.313	1.250	8-32	0.29	AL
2MR-120S-09	120	3.008	2.988	----	6	0.500	0.875	1.500	0.375	0.313	1.250	10-32	0.31	AL

\* Plain bore style stocked in smallest bore \*\* 12-16 Groove pulleys have 1 set screw, all others have 2 at 90 degrees \*\*\* Clear Anodize Finish

**NOTE:** See Synchronous Belt Drives – Sprocket Specifications section, Page 73, for a complete table of stock and non-stock sprocket diameters.

For non-standard designs contact Gates Made-To-Order Metals Team at (800)709-6001

# PowerGrip® GT®3 Belt Drives

## Sprocket Specification Tables – 3mm Pitch PowerGrip® GT®2 Sprockets

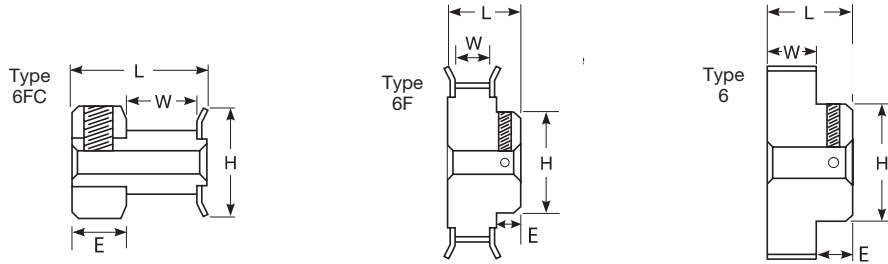

### 6mm (0.236 in) Wide Belts (3MGT-06)

Sprocket Number	No. of Grooves	Diameter (in)			Design Type	Dimensions (in)						Set Screws**	Wt. (lb)	Material***
		Pitch	OD	Flange Ref.		W	L	H	E	Plain Bore* (in)				
										Min	Max			
3MR-16S-06	16	0.602	0.572	0.710	6FC	0.280	0.562	0.710	0.230	0.188	0.250	6-40	0.01	AL
3MR-17S-06	17	0.639	0.609	0.740	6FC	0.280	0.562	0.740	0.230	0.188	0.250	6-40	0.01	AL
3MR-18S-06	18	0.677	0.647	0.790	6F	0.280	0.691	0.442	0.305	0.250	0.250	8-32	0.01	AL
3MR-19S-06	19	0.714	0.684	0.815	6F	0.280	0.691	0.468	0.305	0.250	0.250	8-32	0.02	AL
3MR-20S-06	20	0.752	0.722	0.895	6F	0.280	0.691	0.500	0.305	0.250	0.250	8-32	0.02	AL
3MR-21S-06	21	0.790	0.760	0.895	6F	0.280	0.691	0.500	0.305	0.250	0.250	8-32	0.02	AL
3MR-22S-06	22	0.827	0.797	0.945	6F	0.280	0.691	0.562	0.305	0.250	0.313	8-32	0.02	AL
3MR-24S-06	24	0.902	0.872	1.025	6F	0.280	0.691	0.625	0.305	0.250	0.375	8-32	0.03	AL
3MR-25S-06	25	0.940	0.910	1.060	6F	0.280	0.691	0.625	0.305	0.250	0.375	8-32	0.03	AL
3MR-26S-06	26	0.977	0.947	1.105	6F	0.280	0.691	0.625	0.305	0.250	0.375	8-32	0.03	AL
3MR-28S-06	28	1.053	1.023	1.173	6F	0.280	0.691	0.701	0.305	0.250	0.500	8-32	0.04	AL
3MR-30S-06	30	1.128	1.098	1.250	6F	0.280	0.691	0.776	0.305	0.250	0.563	8-32	0.04	AL
3MR-32S-06	32	1.203	1.173	1.323	6F	0.280	0.691	0.851	0.305	0.250	0.625	8-32	0.04	AL
3MR-34S-06	34	1.278	1.248	1.398	6F	0.280	0.713	0.921	0.306	0.250	0.688	8-32	0.06	AL
3MR-36S-06	36	1.353	1.323	1.473	6F	0.280	0.713	1.000	0.306	0.250	0.750	8-32	0.07	AL
3MR-38S-06	38	1.429	1.399	1.549	6F	0.280	0.713	1.075	0.306	0.250	0.875	8-32	0.08	AL
3MR-40S-06	40	1.504	1.474	1.625	6F	0.280	0.713	1.150	0.306	0.250	0.938	8-32	0.08	AL
3MR-44S-06	44	1.654	1.624	1.775	6F	0.280	0.713	1.300	0.306	0.250	1.000	8-32	0.12	AL
3MR-45S-06	45	1.692	1.662	1.775	6F	0.28	0.713	1.300	0.306	0.250	1.000	8-32	0.12	AL
3MR-48S-06	48	1.805	1.775	---	6	0.407	0.734	1.250	0.327	0.313	1.000	8-32	0.13	AL
3MR-50S-06	50	1.880	1.850	---	6	0.407	0.734	1.250	0.327	0.313	1.000	8-32	0.14	AL
3MR-56S-06	56	2.105	2.075	---	6	0.407	0.734	1.250	0.327	0.313	1.000	8-32	0.16	AL
3MR-60S-06	60	2.256	2.226	---	6	0.407	0.734	1.250	0.327	0.313	1.000	8-32	0.18	AL
3MR-62S-06	62	2.331	2.301	---	6	0.407	0.734	1.250	0.327	0.313	1.000	8-32	0.19	AL
3MR-68S-06	68	2.557	2.527	---	6	0.407	0.734	1.250	0.327	0.313	1.000	8-32	0.23	AL
3MR-72S-06	72	2.707	2.677	---	6	0.407	0.734	1.250	0.327	0.313	1.000	8-32	0.25	AL
3MR-74S-06	74	2.782	2.752	---	6	0.407	0.734	1.250	0.327	0.313	1.000	8-32	0.26	AL
3MR-80S-06	80	3.008	2.978	---	6	0.407	0.734	1.250	0.327	0.313	1.000	8-32	0.31	AL

\* Plain bore style stocked in smallest bore \*\* 2 ea. set screws at 90 degrees \*\*\* Clear Anodize Finish

**NOTE:** See Synchronous Belt Drives – Sprocket Specifications section, Page 74, for a complete table of stock and non-stock sprocket diameters.

For non-standard designs contact Gates Made-To-Order Metals Team at (800)709-6001



# PowerGrip® GT®3 Belt Drives

## Sprocket Specification Tables – 3mm Pitch PowerGrip® GT®2 Sprockets - Continued

### 9mm (0.354 in) Wide Belts (3MGT-09)

Sprocket Number	No. of Grooves	Diameter (in)			Design Type	Dimensions (in)						Set Screws**	Wt. (lb)	Material***
		Pitch	OD	Flange Ref.						Plain Bore* (in)				
						W	L	H	E	Min	Max			
3MR-16S-09	16	0.602	0.572	0.710	6C	0.400	0.691	0.710	0.238	0.188	0.250	6-40	0.02	AL
3MR-17S-09	17	0.639	0.609	0.740	6C	0.400	0.691	0.740	0.238	0.188	0.250	6-40	0.02	AL
3MR-18S-09	18	0.677	0.647	0.790	6F	0.400	0.812	0.442	0.306	0.250	0.250	8-32	0.02	AL
3MR-19S-09	19	0.714	0.684	0.815	6F	0.400	0.812	0.468	0.306	0.250	0.250	8-32	0.02	AL
3MR-20S-09	20	0.752	0.722	0.895	6F	0.400	0.812	0.500	0.306	0.250	0.250	8-32	0.02	AL
3MR-21S-09	21	0.790	0.760	0.895	6F	0.400	0.812	0.500	0.306	0.250	0.250	8-32	0.03	AL
3MR-22S-09	22	0.827	0.797	0.945	6F	0.400	0.812	0.562	0.306	0.250	0.313	8-32	0.03	AL
3MR-24S-09	24	0.902	0.872	1.025	6F	0.400	0.812	0.625	0.306	0.250	0.375	8-32	0.03	AL
3MR-25S-09	25	0.940	0.910	1.060	6F	0.400	0.812	0.625	0.306	0.250	0.375	8-32	0.04	AL
3MR-26S-09	26	0.977	0.947	1.105	6F	0.400	0.812	0.625	0.306	0.250	0.375	8-32	0.04	AL
3MR-28S-09	28	1.053	1.023	1.173	6F	0.400	0.812	0.701	0.306	0.250	0.500	8-32	0.05	AL
3MR-30S-09	30	1.128	1.098	1.250	6F	0.400	0.812	0.776	0.306	0.250	0.563	8-32	0.05	AL
3MR-32S-09	32	1.203	1.173	1.323	6F	0.400	0.812	0.851	0.306	0.250	0.625	8-32	0.06	AL
3MR-34S-09	34	1.278	1.248	1.398	6F	0.400	0.833	0.921	0.306	0.250	0.688	8-32	0.08	AL
3MR-36S-09	36	1.353	1.323	1.473	6F	0.400	0.833	1.000	0.306	0.250	0.750	8-32	0.09	AL
3MR-38S-09	38	1.429	1.399	1.549	6F	0.400	0.833	1.075	0.306	0.250	0.875	8-32	0.10	AL
3MR-40S-09	40	1.504	1.474	1.625	6F	0.400	0.833	1.150	0.306	0.250	0.938	8-32	0.11	AL
3MR-44S-09	44	1.654	1.624	1.775	6F	0.400	0.833	1.300	0.306	0.250	1.000	8-32	0.12	AL
3MR-45S-09	45	1.692	1.662	1.775	6	0.400	0.833	1.300	0.306	0.250	1.000	8-32	0.14	AL
3MR-48S-09	48	1.805	1.775	---	6	0.500	0.875	1.250	0.375	0.313	1.000	8-32	0.15	AL
3MR-50S-09	50	1.880	1.850	---	6	0.500	0.875	1.250	0.375	0.313	1.000	8-32	0.16	AL
3MR-56S-09	56	2.105	2.075	---	6	0.500	0.875	1.250	0.375	0.313	1.000	8-32	0.20	AL
3MR-60S-09	60	2.256	2.226	---	6	0.500	0.875	1.250	0.375	0.313	1.000	8-32	0.22	AL
3MR-62S-09	62	2.331	2.301	---	6	0.500	0.875	1.250	0.375	0.313	1.000	8-32	0.23	AL
3MR-68S-09	68	2.557	2.527	---	6	0.500	0.875	1.250	0.375	0.313	1.000	8-32	0.28	AL
3MR-72S-09	72	2.707	2.677	---	6	0.500	0.875	1.250	0.375	0.313	1.000	8-32	0.31	AL
3MR-74S-09	74	2.782	2.752	---	6	0.500	0.875	1.250	0.375	0.313	1.000	8-32	0.32	AL
3MR-80S-09	80	3.008	2.978	---	6	0.500	0.875	1.250	0.375	0.313	1.000	8-32	0.37	AL
3MR-90S-09	90	3.384	3.354	---	6	0.500	0.875	1.250	0.375	0.313	1.000	8-32	0.42	AL
3MR-100S-09	100	3.760	3.730	---	6	0.500	0.875	1.250	0.375	0.313	1.000	8-32	0.50	AL
3MR-120S-09	120	4.511	4.481	---	6	0.500	0.875	1.250	0.375	0.313	1.000	8-32	0.62	AL

\* Plain bore style stocked in smallest bore \*\* 2 ea. set screws at 90 degrees \*\*\* Clear Anodize Finish

**NOTE:** See Synchronous Belt Drives – Sprocket Specifications section, Page 74, for a complete table of stock and non-stock sprocket diameters.

For non-standard designs contact Gates Made-To-Order Metals Team at (800)709-6001

# PowerGrip® GT®3 Belt Drives

## Sprocket Specification Tables – 3mm Pitch PowerGrip® GT®2 Sprockets - Continued

15mm (0.591 in) Wide Belts (3MGT-15)														
Sprocket Number	No. of Grooves	Diameter (in)			Design Type	Dimensions (in)						Set Screws**	Wt. (lb)	Material***
		Pitch	OD	Flange Ref.		W	L	H	E	Plain Bore* (in)				
										Min	Max			
3MR-16S-15	16	0.602	0.572	0.710	6FC	0.583	0.927	0.710	0.238	0.188	0.250	6-40	0.02	AL
3MR-17S-15	17	0.639	0.609	0.740	6FC	0.583	0.927	0.710	0.238	0.188	0.250	6-40	0.02	AL
3MR-18S-15	18	0.677	0.647	0.790	6F	0.636	1.057	0.442	0.315	0.250	0.250	8-32	0.02	AL
3MR-19S-15	19	0.714	0.684	0.815	6F	0.636	1.057	0.468	0.315	0.250	0.250	8-32	0.02	AL
3MR-20S-15	20	0.752	0.722	0.895	6F	0.636	1.057	0.500	0.315	0.250	0.250	8-32	0.03	AL
3MR-21S-15	21	0.790	0.760	0.895	6F	0.636	1.057	0.500	0.315	0.250	0.250	8-32	0.03	AL
3MR-22S-15	22	0.827	0.797	0.945	6F	0.636	1.057	0.562	0.315	0.250	0.313	8-32	0.04	AL
3MR-24S-15	24	0.902	0.872	1.025	6F	0.636	1.057	0.625	0.315	0.250	0.375	8-32	0.04	AL
3MR-25S-15	25	0.940	0.910	1.060	6F	0.636	1.057	0.625	0.315	0.250	0.375	8-32	0.05	AL
3MR-26S-15	26	0.977	0.947	1.105	6F	0.636	1.057	0.625	0.315	0.250	0.375	8-32	0.05	AL
3MR-28S-15	28	1.053	1.023	1.173	6F	0.636	1.057	0.701	0.315	0.250	0.500	8-32	0.06	AL
3MR-30S-15	30	1.128	1.098	1.250	6F	0.636	1.057	0.776	0.315	0.250	0.563	8-32	0.07	AL
3MR-32S-15	32	1.203	1.173	1.323	6F	0.636	1.057	0.851	0.315	0.250	0.625	8-32	0.09	AL
3MR-34S-15	34	1.278	1.248	1.398	6F	0.657	1.069	0.921	0.306	0.250	0.688	8-32	0.10	AL
3MR-36S-15	36	1.353	1.323	1.473	6F	0.657	1.069	1.000	0.306	0.250	0.750	8-32	0.12	AL
3MR-38S-15	38	1.429	1.399	1.549	6F	0.657	1.069	1.075	0.306	0.250	0.875	8-32	0.13	AL
3MR-40S-15	40	1.504	1.474	1.625	6F	0.657	1.069	1.150	0.306	0.250	0.938	8-32	0.15	AL
3MR-44S-15	44	1.654	1.624	1.775	6F	0.657	1.069	1.300	0.306	0.250	1.000	8-32	0.18	AL
3MR-45S-15	45	1.692	1.662	1.775	6	0.657	1.069	1.250	0.306	0.250	1.000	8-32	0.19	AL
3MR-48S-15	48	1.805	1.775	---	6	0.736	1.111	1.250	0.375	0.313	1.000	8-32	0.21	AL
3MR-50S-15	50	1.880	1.850	---	6	0.736	1.111	1.250	0.375	0.313	1.000	8-32	0.22	AL
3MR-56S-15	56	2.105	2.075	---	6	0.736	1.111	1.250	0.375	0.313	1.000	8-32	0.27	AL
3MR-60S-15	60	2.256	2.226	---	6	0.736	1.111	1.250	0.375	0.313	1.000	8-32	0.30	AL
3MR-62S-15	62	2.331	2.301	---	6	0.736	1.111	1.250	0.375	0.313	1.000	8-32	0.32	AL
3MR-68S-15	68	2.557	2.527	---	6	0.736	1.111	1.250	0.375	0.313	1.000	8-32	0.38	AL
3MR-72S-15	72	2.707	2.677	---	6	0.736	1.111	1.250	0.375	0.313	1.000	8-32	0.43	AL
3MR-74S-15	74	2.782	2.752	---	6	0.736	1.111	1.250	0.375	0.313	1.000	8-32	0.45	AL
3MR-80S-15	80	3.008	2.978	---	6	0.736	1.111	1.250	0.375	0.313	1.000	8-32	0.52	AL
3MR-90S-15	90	3.384	3.354	---	6	0.736	1.111	1.250	0.375	0.313	1.000	8-32	0.60	AL
3MR-100S-15	100	3.760	3.730	---	6	0.736	1.111	1.250	0.375	0.313	1.000	8-32	0.73	AL
3MR-120S-15	120	4.511	4.481	---	6	0.736	1.111	1.250	0.375	0.313	1.000	8-32	0.85	AL

\* Plain bore style stocked in smallest bore \*\* 2 ea. set screws at 90 degrees \*\*\* Clear Anodize Finish

**NOTE:** See Synchronous Belt Drives – Sprocket Specifications section, Page 74, for a complete table of stock and non-stock sprocket diameters.

For non-standard designs contact Gates Made-To-Order Metals Team at (800)709-6001

# PowerGrip® GT®3 Belt Drives

## Sprocket Specification Tables – 5mm Pitch PowerGrip® GT®2 Sprockets

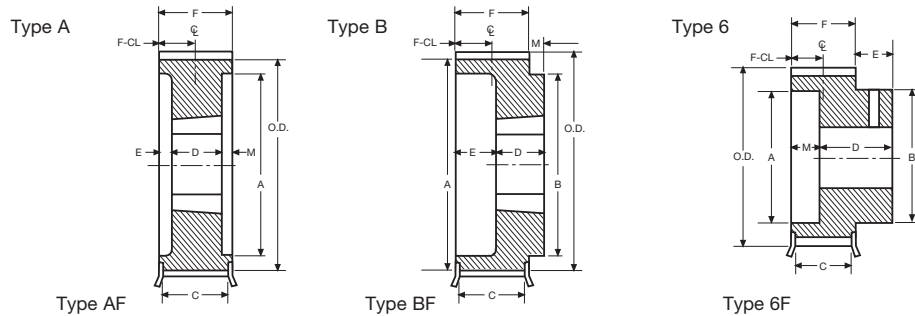

### 15mm (0.591 in) Wide Belts (5MGT-15)

Sprocket Number	No. of Grooves	Diameter (in)			Design Type	Dimensions (in)								Bushing Size	Bore Sizes (in)		Approx. Wt. (lb)	Approx. WR2	Material
		Pitch	OD	Flange Ref.		A	B	C	D	E	F	M	F-CL		Min	Max			
P18-5MGT-15-MPB	18	1.128	1.083	1.375	6F	---	0.68	0.71	1.25	0.36	0.89	0.00	0.81	MPB	0.250	0.375	0.24	0.0000	S
P19-5MGT-15-MPB	19	1.191	1.146	1.438	6F	---	0.88	0.71	1.25	0.36	0.89	0.00	0.81	MPB	0.250	0.437	0.28	0.0000	S
P20-5MGT-15-MPB	20	1.253	1.208	1.531	6F	---	0.90	0.71	1.25	0.36	0.89	0.00	0.81	MPB	0.250	0.500	0.32	0.0000	S
P21-5MGT-15-MPB	21	1.316	1.271	1.531	6F	---	0.90	0.71	1.25	0.36	0.89	0.00	0.81	MPB	0.250	0.500	0.36	0.0010	S
P22-5MGT-15-MPB	22	1.379	1.334	1.656	6F	---	0.94	0.71	1.28	0.39	0.89	0.00	0.84	MPB	0.250	0.500	0.40	0.0010	S
P23-5MGT-15-MPB	23	1.441	1.396	1.656	6F	---	1.15	0.71	1.28	0.39	0.89	0.00	0.84	MPB	0.375	0.625	0.44	0.0010	S
P24-5MGT-15-MPB	24	1.504	1.459	1.781	6F	---	1.18	0.71	1.28	0.39	0.89	0.00	0.84	MPB	0.375	0.625	0.47	0.0010	S
P25-5MGT-15-MPB	25	1.566	1.521	1.781	6F	---	1.18	0.71	1.28	0.39	0.89	0.00	0.84	MPB	0.375	0.625	0.51	0.0010	S
P26-5MGT-15-MPB	26	1.629	1.584	1.906	6F	---	1.21	0.71	1.28	0.39	0.89	0.00	0.84	MPB	0.375	0.687	0.57	0.0010	S
P28-5MGT-15-MPB	28	1.754	1.709	2.031	6F	---	1.37	0.71	1.34	0.45	0.89	0.00	0.90	MPB	0.500	0.750	0.67	0.0020	S
P30-5MGT-15-MPB	30	1.880	1.835	2.125	6F	---	1.44	0.71	1.34	0.45	0.89	0.00	0.90	MPB	0.500	0.937	0.75	0.0020	S
P32-5MGT-15-MPB	32	2.005	1.960	2.125	6F	---	1.44	0.71	1.34	0.45	0.89	0.00	0.90	MPB	0.500	0.937	0.88	0.0030	S
P34-5MGT-15-MPB	34	2.130	2.085	2.375	6F	---	1.69	0.71	1.34	0.45	0.89	0.00	0.90	MPB	0.500	1.000	1.04	0.0040	S
P36-5MGT-15-MPB	36	2.256	2.211	2.375	6F	---	1.69	0.71	1.34	0.45	0.89	0.00	0.90	MPB	0.500	1.125	1.12	0.0050	S
P36-5MGT-15	36	2.256	2.211	2.375	AF	---	---	0.71	0.88	0.00	0.88	0.00	0.44	1108	0.500	1.000	0.50	0.0020	S
P38-5MGT-15-MPB	38	2.381	2.336	2.625	6F	---	1.96	0.71	1.34	0.45	0.89	0.00	0.90	MPB	0.500	1.250	1.35	0.0060	S
P38-5MGT-15	38	2.381	2.336	2.625	AF	---	---	0.71	0.88	0.00	0.89	0.00	0.45	1108	0.500	1.000	0.61	0.0030	S
P40-5MGT-15-MPB	40	2.506	2.461	2.750	6F	---	2.09	0.71	1.38	0.49	0.89	0.00	0.94	MPB	0.500	1.312	1.55	0.0080	S
P40-5MGT-15	40	2.506	2.461	2.750	AF	---	---	0.71	0.88	0.00	0.89	0.00	0.45	1108	0.500	1.000	0.72	0.0040	S
P44-5MGT-15	44	2.757	2.712	3.094	AF	---	---	0.71	0.88	0.00	0.89	0.00	0.45	1108	0.500	1.000	0.95	0.0060	S
P45-5MGT-15-MPB	45	2.820	2.775	3.094	6F	---	2.34	0.71	1.38	0.49	0.89	0.00	0.94	MPB	0.500	1.500	2.00	0.0130	S
P48-5MGT-15	48	3.008	2.963	3.330	BF	---	2.65	0.71	1.00	0.00	0.89	0.13	0.58	1210	0.500	1.250	0.97	0.0070	D
P50-5MGT-15-MPB	50	3.133	3.088	3.330	6F	---	2.50	0.71	1.38	0.49	0.89	0.00	0.94	MPB	0.500	1.750	2.30	0.0190	D
P52-5MGT-15	52	3.258	3.213	3.566	BF	---	2.88	0.71	1.00	0.00	0.89	0.13	0.58	1210	0.500	1.250	1.17	0.0110	D
P56-5MGT-15	56	3.509	3.464	3.800	BF	---	3.03	0.71	1.00	0.00	0.89	0.13	0.58	1610	0.500	1.688	1.37	0.0140	D
P60-5MGT-15	60	3.760	3.715	4.044	BF	---	3.21	0.71	1.00	0.00	0.89	0.13	0.58	1610	0.500	1.688	1.68	0.0200	D
P64-5MGT-15	64	4.010	3.965	4.170	BF	---	3.25	0.71	1.00	0.00	0.89	0.13	0.58	1610	0.500	1.688	1.80	0.0270	D
P68-5MGT-15	68	4.261	4.216	4.520	BF	---	3.25	0.71	1.00	0.00	0.89	0.13	0.58	1610	0.500	1.688	2.10	0.0370	D
P72-5MGT-15	72	4.511	4.466	4.670	BF	---	3.25	0.71	1.00	0.00	0.89	0.13	0.58	1610	0.500	1.688	2.43	0.0470	D
P80-5MGT-15	80	5.013	4.968	---	B	---	3.25	---	1.00	0.00	0.89	0.11	0.56	1610	0.500	1.688	3.15	0.0770	D
P90-5MGT-15	90	5.639	5.594	---	B	---	3.25	---	1.00	0.00	0.89	0.11	0.56	1610	0.500	1.688	4.17	0.0140	D
P112-5MGT-15	112	7.018	6.973	---	B	---	4.38	---	1.25	0.00	0.89	0.36	0.81	2012	0.500	2.125	5.16	0.3500	D

Material Spec: S - Steel D - Ductile Iron

**NOTE:** See Synchronous Belt Drives – Sprocket Specifications section, Page 75, for a complete table of stock and non-stock sprocket diameters.

For non-standard designs contact Gates Made-To-Order Metals Team at (800)709-6001

# PowerGrip® GT®3 Belt Drives

## Sprocket Specification Tables – 5mm Pitch PowerGrip® GT®2 Sprockets - Continued

### 25mm (0.984 in) Wide Belts (5MGT-25)

Sprocket Number	No. of Grooves	Diameter (in)			Design Type	Dimensions (in)										Bushing Size		Bore Sizes (in)		Approx. Wt. (lb)	Approx. WR2	Material
		Pitch	OD	Flange Ref.		A	B	C	D	E	F	M	F-CL	Min	Max							
P18-5MGT-25-MPB	18	1.128	1.083	1.375	6F	---	0.68	1.1	1.65	0.37	1.28	0.00	1.01	MPB	0.250	0.375	0.39	0.0000	S			
P19-5MGT-25-MPB	19	1.191	1.146	1.438	6F	---	0.88	1.1	1.65	0.37	1.28	0.00	1.01	MPB	0.250	0.437	0.43	0.0000	S			
P20-5MGT-25-MPB	20	1.253	1.208	1.531	6F	---	0.90	1.1	1.65	0.37	1.28	0.00	1.01	MPB	0.250	0.500	0.43	0.0000	S			
P21-5MGT-25-MPB	21	1.316	1.271	1.531	6F	---	0.90	1.1	1.65	0.37	1.28	0.00	1.01	MPB	0.250	0.500	0.47	0.0010	S			
P22-5MGT-25-MPB	22	1.379	1.334	1.656	6F	---	0.94	1.1	1.68	0.40	1.28	0.00	1.04	MPB	0.250	0.500	0.55	0.0010	S			
P23-5MGT-25-MPB	23	1.441	1.396	1.656	6F	---	1.15	1.1	1.68	0.40	1.28	0.00	1.04	MPB	0.375	0.625	0.58	0.0010	S			
P24-5MGT-25-MPB	24	1.504	1.459	1.781	6F	---	1.18	1.1	1.68	0.40	1.28	0.00	1.04	MPB	0.375	0.625	0.64	0.0010	S			
P25-5MGT-25-MPB	25	1.566	1.521	1.781	6F	---	1.18	1.1	1.68	0.40	1.28	0.00	1.04	MPB	0.375	0.625	0.69	0.0010	S			
P26-5MGT-25-MPB	26	1.629	1.584	1.906	6F	---	1.21	1.1	1.68	0.40	1.28	0.00	1.04	MPB	0.375	0.687	0.76	0.0010	S			
P28-5MGT-25-MPB	28	1.754	1.709	2.031	6F	---	1.37	1.1	1.73	0.45	1.28	0.00	1.09	MPB	0.500	0.750	0.88	0.0020	S			
P30-5MGT-25-MPB	30	1.880	1.835	2.125	6F	---	1.44	1.1	1.73	0.45	1.28	0.00	1.09	MPB	0.500	0.937	1.00	0.0020	S			
P32-5MGT-25-MPB	32	2.005	1.960	2.125	6F	---	1.44	1.1	1.73	0.45	1.28	0.00	1.09	MPB	0.500	0.937	1.16	0.0030	S			
P34-5MGT-25-MPB	34	2.130	2.085	2.375	6F	---	1.69	1.1	1.73	0.45	1.28	0.00	1.09	MPB	0.500	1.000	1.36	0.0040	S			
P36-5MGT-25-MPB	36	2.256	2.211	2.375	6F	---	1.69	1.1	1.73	0.45	1.28	0.00	1.09	MPB	0.500	1.125	1.48	0.0050	S			
P36-5MGT-25	36	2.256	2.211	2.375	AF	1.72	---	1.1	0.88	0.00	1.29	0.41	1.06	1108	0.500	1.000	0.50	0.0020	S			
P38-5MGT-25-MPB	38	2.381	2.336	2.625	6F	---	1.96	1.1	1.73	0.45	1.28	0.00	1.09	MPB	0.500	1.250	1.70	0.0060	S			
P38-5MGT-25	38	2.381	2.336	2.625	AF	1.75	---	1.1	0.88	0.00	1.29	0.41	1.06	1108	0.500	1.000	0.61	0.0030	S			
P40-5MGT-25-MPB	40	2.506	2.461	2.750	6F	---	2.09	1.1	1.78	0.50	1.28	0.00	1.14	MPB	0.500	1.312	2.10	0.0080	S			
P40-5MGT-25	40	2.506	2.461	2.750	AF	1.75	---	1.1	0.88	0.00	1.29	0.41	1.06	1108	0.500	1.000	0.72	0.0040	S			
P44-5MGT-25	44	2.757	2.712	3.094	AF	1.75	---	1.1	0.88	0.00	1.29	0.41	1.06	1108	0.500	1.000	0.95	0.0060	S			
P45-5MGT-25-MPB	45	2.820	2.775	3.094	6F	---	2.34	1.1	1.78	0.50	1.28	0.00	1.14	MPB	0.500	1.500	2.65	0.0130	S			
P48-5MGT-25	48	3.008	2.963	3.330	AF	2.36	---	1.1	1.00	0.00	1.28	0.28	0.92	1210	0.500	1.250	0.97	0.0070	D			
P50-5MGT-25-MPB	50	3.133	3.088	3.330	6F	---	2.50	1.1	1.78	0.50	1.28	0.00	1.14	MPB	0.500	1.750	3.00	0.0190	D			
P52-5MGT-25	52	3.258	3.213	3.566	AF	2.62	---	1.1	1.00	0.00	1.28	0.28	0.92	1210	0.500	1.250	1.17	0.0110	D			
P56-5MGT-25	56	3.509	3.464	3.800	AF	2.75	---	1.1	1.00	0.00	1.28	0.28	0.92	1610	0.500	1.688	1.37	0.0140	D			
P60-5MGT-25	60	3.760	3.715	4.044	AF	2.90	---	1.1	1.00	0.00	1.28	0.28	0.92	1610	0.500	1.688	1.68	0.0200	D			
P64-5MGT-25	64	4.010	3.965	4.170	AF	3.37	---	1.1	1.00	0.00	1.28	0.28	0.92	1610	0.500	1.688	2.00	0.0270	D			
P68-5MGT-25	68	4.261	4.216	4.520	AF	---	---	1.1	1.25	0.03	1.28	0.00	0.64	2012	0.500	2.125	2.40	0.0370	D			
P72-5MGT-25	72	4.511	4.466	4.670	AF	---	---	1.1	1.25	0.03	1.28	0.00	0.64	2012	0.500	2.125	2.70	0.0470	D			
P80-5MGT-25	80	5.013	4.968	---	A	---	---	---	1.25	0.03	1.28	0.00	0.64	2012	0.500	2.125	3.60	0.0770	D			
P90-5MGT-25	90	5.639	5.594	---	A	---	---	---	1.25	0.03	1.28	0.00	0.64	2012	0.500	2.125	5.00	0.0140	D			
P112-5MGT-25	112	7.018	6.973	---	A	---	---	---	1.25	0.03	1.28	0.00	0.64	2012	0.500	2.125	8.30	0.3500	D			

Material Spec: S - Steel D - Ductile Iron

**NOTE:** See Synchronous Belt Drives – Sprocket Specifications section, Page 75, for a complete table of stock and non-stock sprocket diameters.

For non-standard designs contact Gates Made-To-Order Metals Team at (800)709-6001



# PowerGrip® GT®3 Belt Drives

## Bushing and Shaft Specification Tables – 5mm Pitch PowerGrip® GT®2 Sprockets

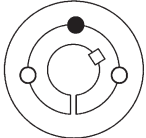

1008 to 2012

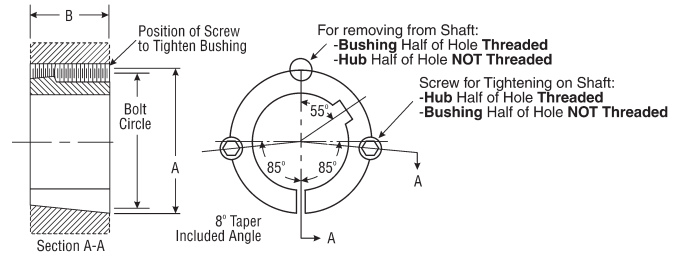

1008 thru 3020

Bushing Size	Torque Capacity (lb-in)	Dimensions (in)		Bolt Circle (in)	Mounting Screws		Bore Range (in)			Weight Range (lb)		Keyseat (in)
		A	B		Qty.	Size	Min. Bore	Max Bore		Max. Bore	Min. Bore	
								Standard Keyseat	Shallow Keyseat*			
1008	1,200	1.386	0.875	1.328	2	1/4 x 1/2	0.500	0.875	1.000	0.2	0.3	Standard 1/4 x 1/16
1108	1,300	1.511	0.875	1.328	2	1/4 x 1/2	0.500	1.000	1.125	0.1	0.3	Standard 1/4 x 1/16
1210	3,600	1.875	1.000	1.750	2	3/8 x 5/8	0.500	1.250	—	0.4	0.6	Standard
1610	4,300	2.250	1.000	2.125	2	3/8 x 5/8	0.500	1.500	1.688	0.5	0.9	Standard 3/8 x 1/8
1615	4,300	2.250	1.500	2.125	2	3/8 x 5/8	0.500	1.500	1.688	0.6	1.3	Standard 3/8 x 1/8
2012	7,150	2.750	1.250	2.625	2	7/16 x 7/8	0.500	1.875	2.125	0.9	1.7	Standard 1/2 x 3/16

\* Key is furnished with each bushing having a shallow keyseat.

### Sprocket Installation

#### To Install TAPER-LOCK® Type Bushings

- Clean the shaft, bore of bushing, outside of bushing and the sprocket hub bore of all oil, paint and dirt. File away any burrs.  
**Note:** The use of lubricants can cause sprocket breakage.  
USE NO LUBRICANTS IN THIS INSTALLATION.

- Insert the bushing into the sprocket hub. Match the hole pattern, not threaded holes (each complete hole will be threaded on one side only).

- LIGHTLY oil the set screws and thread them into those half-threaded holes indicated by on the diagram above.

**Note:** Do not lubricate the bushing taper, hub taper, bushing bore, or the shaft. Doing so could result in sprocket breakage.

- With the key in the shaft keyway, position the assembly onto the shaft allowing for small axial movement of the sprocket which will occur during the tightening process.

**Note:** When mounting sprockets on a vertical shaft, precautions must be taken to positively prevent the sprocket and/or bushing from falling during installation.

- Alternately torque the set screws until the sprocket and bushing tapers are completely seated together (at approximately half of the recommended torque; see table below).

**Note:** Do not use worn hex key wrenches. Doing so may result in a loose assembly or may damage screws.

- Check the alignment and sprocket axial runout (wobble), and correct as necessary.

- Continue alternate tightening of the cap screws to the recommended torque values specified in Table 1 on this page.

\* Taper-Lock® is a Registered trademark of Reliance Electric.

- To increase the bushing gripping force, hammer the face of the bushing using a drift or sleeve (Do Not Hit The Bushing Directly With The Hammer).
- Re-torque the bushing screws after hammering.
- Recheck all screw torque values after the initial drive run-in, and periodically thereafter. Repeat steps 5 through 9 if loose.

#### To Remove

**Table 1 – Sprocket Installation**

Bushing Style	Bolts (in)		Torque Wrench (lb-ft) (lb-in)	
	Qty	Size		
1008	2	1/4-20 x 1/2	4.6	55
1108	2	1/4-20 x 1/2	4.6	55
1210	2	3/8-16 x 5/8	14.6	175
1610	2	3/8-16 x 5/8	14.6	175
1615	2	3/8-16 x 5/8	14.6	175
2012	2	7/16-14 x 7/8	23.3	280

- Loosen and remove all mounting screws.
- Insert screws into all jack screw holes indicated by “•” (see figure at top of page).
- Loosen the bushing by alternately tightening the screws in small but equal increments until the tapered sprocket and bushing surfaces disengage.

### Standard Keyseat Dimensions

Shaft Diam. (in)	Keyseat (in)		Key (in)	
	Width	Depth	Width	Depth
0.313-0.438	3/32	3/64	3/32	3/32
0.500-0.563	1/8	1/16	1/8	1/8
0.625-0.875	3/16	3/32	3/16	3/16
0.938-1.250	1/4	1/8	1/4	1/4
1.313-1.375	5/16	5/32	5/16	5/16
1.438-1.750	3/8	3/16	3/8	3/8
1.813-2.250	1/2	1/4	1/2	1/2

#### For Minimum Plain Bore (MPB) Sprockets

When using MPB PowerGrip® GT®2 sprockets in power transmission systems, important guidelines should be followed for proper product finishing and application. Due to the high load carrying capacity and high operating tensions often found in PowerGrip® GT®3 belt drive systems, it is imperative to use and adhere to industry standard practices.

When finishing MPB sprockets for high performance belt drive systems, care should be taken to ensure proper functionality and performance. General re-bore instructions and specifications are as follows:

- Materials used in PowerGrip® GT®2 sprockets are steel, gray iron, and ductile iron. The materials used may vary with the size of the sprocket. See the Sprocket Specification Tables, page 34-35.
- The maximum bore diameter specified by the manufacturer for each sprocket size should NOT be exceeded, or a keyway used which reduces the hub thickness to less than its minimum allowable value. See the Sprocket Specification Tables for a listing of recommended bore ranges by sprocket size. Bores exceeding the maximum recommended value for a particular sprocket size can adversely affect the structural integrity, thereby reducing their load-carrying capability.

## Bushing and Shaft Specification Tables – 5mm Pitch PowerGrip® GT®2 Sprockets - Continued

The minimum metal thickness between the keyway and hub O.D. should be no less than the set screw diameter specified for the corresponding sprocket size. See Figure 1 below.

1. A listing of minimum set screw diameters is included below.

P18-5MGT: 8-32

P19-5MGT thru P22-5MGT: 10-32

P23-5MGT thru P32-5MGT: 1/4

P34-5MGT thru P38-5MGT: 5/16

P40-5MGT thru P50-5MGT: 3/8

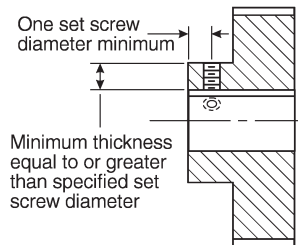

**Figure 1 — Minimum Hub Thickness And Set Screw Placement Guidelines**

3. The fit between a finished sprocket bore and its mating shaft in a power transmission system must not allow relative movement between the bore and the shaft when the drive is subjected to belt tension and torque loads. This is accomplished, in the case of plain bore sprockets, with the use of set screws and keys and by controlling the fit or clearance between the sprocket bore and its mating shaft. Cyclical, pulsating, or reversing loads may wear the sprocket bore and/or keyway due to the relative movement between the contacting surfaces of the shaft and the bore. The resulting wear may increase the clearance further, if an interference fit is not used.

In order to maximize the performance of high capacity belt drives using plain bore style sprockets, the following for recommendations presented in Table 2 should be followed:

Class 1 Clearance Fits should be used when the transmitted load is smooth in nature.

Interference Fits should be used for PowerGrip GT3 curvilinear drives transmitting cyclical, pulsating, or reversing loads.

**Table 2 - Recommended Shaft / Bore Fits (Inches)**

Nominal Bore Range Over - To (Incl.)	Shaft Tol. (minus)	Clearance Fits		Interference Fits			
		Class 1- Smooth Load		Cyclical, Pulsating, Reversing Load			
		Bore Tol. (Plus)	Fit Tol. (Plus)	Bore Tolerance Range (Minus)		Fit Tolerance Range (Minus)	
0.4375 - 0.5626	0.0005	0.0010	0.0015	0.0005	0.0010	0.0000	0.0010
0.5625 - 0.8750	0.0005	0.0010	0.0015	0.0005	0.0010	0.0000	0.0010
0.8750 - 1.2500	0.0005	0.0010	0.0015	0.0005	0.0010	0.0000	0.0010
1.2500 - 1.3750	0.0005	0.0010	0.0015	0.0005	0.0010	0.0000	0.0010
1.3750 - 1.500	0.0005	0.0010	0.0015	0.0005	0.0010	0.0000	0.0010
1.5000 - 1.7500	0.0010	0.0010	0.0020	0.0010	0.0020	0.0000	0.0020

**Table 2 was extracted in part from AGMA Standard for Bores and Keyways for Flexible Couplings (Inch Series) AGMA 9002-A86 Table.**

4. DO NOT chuck or center the sprocket on guide flanges. Soft jaws should be used when chucking on the sprocket teeth. Center (indicate) the sprocket using the sprocket tooth O.D.

If chucked on the Rim I.D. or Hub O.D., the sprocket should be centered with respect to the sprocket tooth O.D. Guide flanges are permanently mounted and should not be re-moved. If original flanges must be removed, they should be replaced with NEW flanges. New guide flanges should be attached securely with care using mechanical fasteners such as screws. Note: Improper guide flange reassembly may cause serious personal injury and/or mechanical damage.

5. Set screw holes in the sprocket hub must be placed properly for maximum holding strength. For both standard and shallow keyseats, two (2) set screws should be used as illustrated in Figure 2. The total holding strength of the set screws is dependent upon their placement and design. Generally, one screw should be placed directly over the keyway, and the other screw at ninety degrees (90°) from the keyway, or at sixty-five degrees (65°) from the keyway—a more recent practice that improves holding power. Sometimes four set screws (or two pair) are used for increased holding strength.

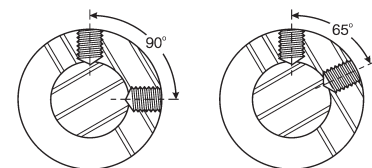

**Figure 2 - Set Screw Angles**

### For Minimum Plain Bore (MPB) Sprockets

Each set screw should be placed axially—a minimum of one set screw diameter from the end of the sprocket hub extension. See Figure 1. For recommended set screw tightening torque values see Table 3 below.

**Table 3—Recommended Tightening Torque Values For Set Screws**

Set Screw Size	Hex Key Size (in)	Approximate Installation Torque Values (lb-in)
8-32	5/64	20
10-32	3/32	35
1/4	1/8	80
5/16	5/32	160
3/8	3/16	275
7/16	7/32	430
1/2	1/4	615
5/8	5/16	1315

6. After re-boring, the sprocket may require rebalancing. Vibration, noise, reduced bearing life, and undue stresses on the mechanical components in the system could result if improper rebalancing practices are used. See Sprocket Specifications, page 77, for recommended sprocket balancing specifications.

7. Standard square or rectangular keys should be used. See page 36 for standard key dimensions.

Refer to Sprocket Specifications, page 77, for specifications and tolerances for sprocket eccentricity, parallelism, and balancing.



## Single Sided Belt Drive Systems

Gates 3mm and 5mm pitch HTD belts have components identical to the larger-sized 8mm and 14mm pitch HTD belts – helically-wound fiberglass tension members embedded in a Neoprene body with the belt teeth faced with a tough wear-resistant nylon fabric.

The three principal dimensions in millimeters, shown below, are used to specify an HTD belt.

300	3M	09
Pitch Length	Pitch	Width

Belt pitch is the distance in millimeters between two adjacent tooth centers as measured on the pitch line of the belt. Belt pitch length is the total length (circumference) in millimeters as measured along the pitch line. The theoretical pitch line of an HTD belt lies within the tensile member.

The three principal dimensions used to specify a sprocket – number of grooves, pitch and belt width in millimeters – are shown below.

P22	3M	09
Number of Grooves	Pitch	Belt Width

**NOTE:** For drive design procedure, see page 12.

Belt tooth to sprocket groove clearance is greater in PowerGrip HTD drives than in PowerGrip Timing drives. If the higher torque capacity of PowerGrip HTD is required together with minimal backlash characteristics, use PowerGrip® GT®3.

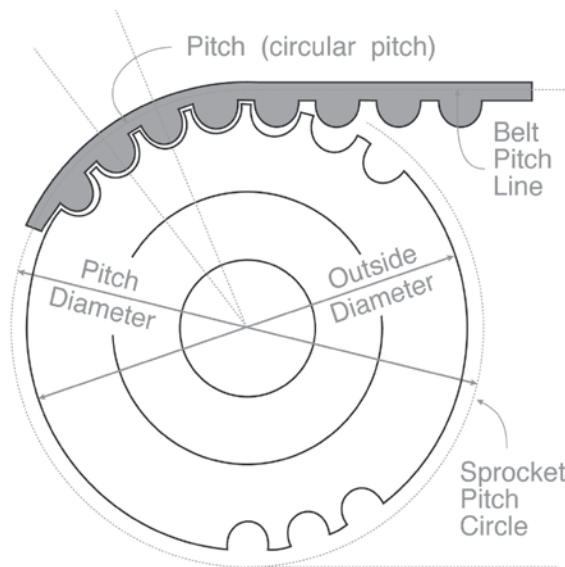

### 3mm Pitch – Reference Dimensions

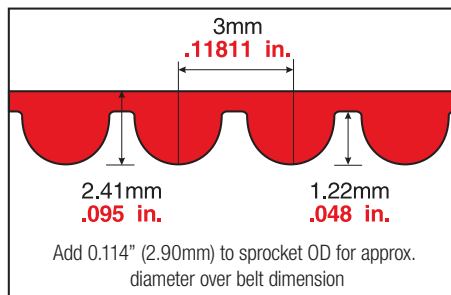

### 5mm Pitch – Reference Dimensions

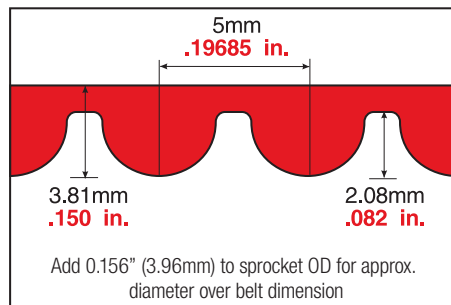

# PowerGrip® HTD® Belt Drives

## PowerGrip HTD Belt Lengths

3mm Pitch Belt Lengths											
Description	Pitch Length		No. of Teeth	Description	Pitch Length		No. of Teeth	Description	Pitch Length		No. of Teeth
	(in)	(mm)			(in)	(mm)			(in)	(mm)	
•87-3M	3.425	87	29	•330-3M	12.992	330	110	•606-3M	23.858	606	202
•102-3M	4.016	102	34	•333-3M	13.110	333	111	•609-3M	23.976	609	203
•105-3M	4.134	105	35	•336-3M	13.228	336	112	•612-3M	24.094	612	204
•111-3M	4.370	111	37	•339-3M	13.346	339	113	•627-3M	24.685	627	209
•123-3M	4.843	123	41	•345-3M	13.583	345	115	•633-3M	24.921	633	211
126-3M	4.961	126	42	•357-3M	14.055	357	119	•639-3M	25.157	639	213
129-3M	5.079	129	43	•360-3M	14.173	360	120	•645-3M	25.394	645	215
141-3M	5.551	141	47	•363-3M	14.291	363	121	•648-3M	25.512	648	216
•144-3M	5.669	144	48	•366-3M	14.409	366	122	•654-3M	25.748	654	218
•147-3M	5.787	147	49	•369-3M	14.528	369	123	•657-3M	25.866	657	219
•150-3M	5.906	150	50	•372-3M	14.646	372	124	•663-3M	26.102	663	221
•156-3M	6.142	156	52	•381-3M	15.000	381	127	•669-3M	26.339	669	223
•159-3M	6.260	159	53	•384-3M	15.118	384	128	672-3M	26.457	672	224
•165-3M	6.496	165	55	•387-3M	15.236	387	129	681-3M	26.811	681	227
•168-3M	6.614	168	56	•390-3M	15.354	390	130	•684-3M	26.929	684	228
•174-3M	6.850	174	58	•396-3M	15.591	396	132	•687-3M	27.047	687	229
•177-3M	6.969	177	59	•399-3M	15.709	399	133	•696-3M	27.402	696	232
•180-3M	7.087	180	60	•405-3M	15.945	405	135	•711-3M	27.992	711	237
•183-3M	7.205	183	61	•411-3M	16.181	411	137	720-3M	28.346	720	240
186-3M	7.323	186	62	•417-3M	16.417	417	139	•735-3M	28.937	735	245
•189-3M	7.441	189	63	•420-3M	16.535	420	140	•738-3M	29.055	738	246
192-3M	7.559	192	64	•426-3M	16.772	426	142	•753-3M	29.646	753	251
•195-3M	7.677	195	65	•432-3M	17.008	432	144	•795-3M	31.299	795	265
•201-3M	7.913	201	67	•435-3M	17.126	435	145	804-3M	31.654	804	268
•204-3M	8.031	204	68	•438-3M	17.244	438	146	•822-3M	32.362	822	274
•207-3M	8.150	207	69	•444-3M	17.480	444	148	•837-3M	32.953	837	279
210-3M	8.268	210	70	•447-3M	17.598	447	149	•843-3M	33.189	843	281
•213-3M	8.386	213	71	•459-3M	18.071	459	153	•873-3M	34.370	873	291
•216-3M	8.504	216	72	462-3M	18.189	462	154	•882-3M	34.724	882	294
219-3M	8.622	219	73	465-3M	18.307	465	155	•891-3M	35.079	891	297
•222-3M	8.740	222	74	•468-3M	18.425	468	156	•900-3M	35.433	900	300
•225-3M	8.858	225	75	•471-3M	18.543	471	157	•915-3M	36.024	915	305
•228-3M	8.976	228	76	•474-3M	18.661	474	158	•945-3M	37.205	945	315
•234-3M	9.213	234	78	477-3M	18.780	477	159	•951-3M	37.441	951	317
•237-3M	9.331	237	79	•480-3M	18.898	480	160	•981-3M	38.622	981	327
•240-3M	9.449	240	80	•486-3M	19.134	486	162	•1002-3M	39.449	1002	334
•246-3M	9.685	246	82	•489-3M	19.252	489	163	•1026-3M	40.394	1026	342
249-3M	9.803	249	83	•492-3M	19.370	492	164	•1035-3M	40.748	1035	345
•252-3M	9.921	252	84	•501-3M	19.724	501	167	1056-3M	41.575	1056	352
•255-3M	10.039	255	85	•510-3M	20.079	510	170	•1062-3M	41.811	1062	354
•258-3M	10.157	258	86	•513-3M	20.197	513	171	1071-3M	42.165	1071	357
•261-3M	10.276	261	87	•519-3M	20.433	519	173	1080-3M	42.520	1080	360
•264-3M	10.394	264	88	522-3M	20.551	522	174	•1125-3M	44.291	1125	375
•267-3M	10.512	267	89	•525-3M	20.669	525	175	•1155-3M	45.472	1155	385
270-3M	10.630	270	90	•528-3M	20.787	528	176	•1191-3M	46.890	1191	397
•276-3M	10.866	276	92	•531-3M	20.906	531	177	1245-3M	49.016	1245	415
•282-3M	11.102	282	94	•537-3M	21.142	537	179	1260-3M	49.606	1260	420
•285-3M	11.220	285	95	552-3M	21.732	552	184	•1263-3M	49.724	1263	421
•288-3M	11.339	288	96	•558-3M	21.969	558	186	•1500-3M	59.055	1500	500
•291-3M	11.457	291	97	•564-3M	22.205	564	188	•1512-3M	59.528	1512	504
294-3M	11.575	294	98	•570-3M	22.441	570	190	1530-3M	60.236	1530	510
•297-3M	11.693	297	99	573-3M	22.559	573	191	•1587-3M	62.480	1587	529
•300-3M	11.811	300	100	•576-3M	22.677	576	192	1863-3M	73.346	1863	621
306-3M	12.047	306	102	•585-3M	23.031	585	195	1926-3M	75.827	1926	642
•312-3M	12.283	312	104	•591-3M	23.268	591	197	1944-3M	76.535	1944	648
•315-3M	12.402	315	105	594-3M	23.386	594	198	•1956-3M	77.008	1956	652
•318-3M	12.520	318	106	•597-3M	23.504	597	199	•2004-3M	78.898	2004	668
•324-3M	12.756	324	108	•600-3M	23.622	600	200				

Stock lengths are denoted by a •. All other sizes, contact Gates Customer Service for availability.

### 3mm Pitch Stock Belt Widths

Belt Width Code	Belt Width (mm)	Belt Width (in)
06	6	0.236
09	9	0.354
15	15	0.591



# PowerGrip® HTD® Belt Drives

## PowerGrip HTD Belt Lengths - Continued

### 5mm Pitch Belt Lengths

Description	Pitch Length		No. of Teeth	Description	Pitch Length		No. of Teeth	Description	Pitch Length		No. of Teeth
	(in)	(mm)			(in)	(mm)			(in)	(mm)	
180-5M	7.087	180	36	•565-5M	22.244	565	113	•1000-5M	39.370	1000	200
•200-5M	7.874	200	40	575-5M	22.638	575	115	1025-5M	40.354	1025	205
225-5M	8.858	225	45	•580-5M	22.835	580	116	1035-5M	40.748	1035	207
•240-5M	9.449	240	48	•585-5M	23.031	585	117	•1050-5M	41.339	1050	210
255-5M	10.039	255	51	590-5M	23.228	590	118	1100-5M	43.307	1100	220
•260-5M	10.236	260	52	•600-5M	23.622	600	120	•1115-5M	43.898	1115	223
265-5M	10.433	265	53	610-5M	24.016	610	122	•1125-5M	44.291	1125	225
•270-5M	10.630	270	54	•615-5M	24.213	615	123	1135-5M	44.685	1135	227
275-5M	10.827	275	55	•635-5M	25.000	635	127	1175-5M	46.260	1175	235
280-5M	11.024	280	56	640-5M	25.197	640	128	•1195-5M	47.047	1195	239
•285-5M	11.220	285	57	645-5M	25.394	645	129	1200-5M	47.244	1200	240
295-5M	11.614	295	59	•655-5M	25.787	655	131	1225-5M	48.228	1225	245
•300-5M	11.811	300	60	•665-5M	26.181	665	133	•1250-5M	49.213	1250	250
305-5M	12.008	305	61	•670-5M	26.378	670	134	•1270-5M	50.000	1270	254
•310-5M	12.205	310	62	•680-5M	26.772	680	136	•1295-5M	50.984	1295	259
•320-5M	12.598	320	64	•685-5M	26.969	685	137	1350-5M	53.150	1350	270
325-5M	12.795	325	65	•695-5M	27.362	695	139	•1375-5M	54.134	1375	275
330-5M	12.992	330	66	700-5M	27.559	700	140	•1420-5M	55.906	1420	284
335-5M	13.189	335	67	•710-5M	27.953	710	142	•1575-5M	62.008	1575	315
340-5M	13.386	340	68	•740-5M	29.134	740	148	•1595-5M	62.795	1595	319
345-5M	13.583	345	69	•745-5M	29.331	745	149	•1635-5M	64.370	1635	327
•350-5M	13.780	350	70	750-5M	29.528	750	150	•1690-5M	66.535	1690	338
360-5M	14.173	360	72	755-5M	29.724	755	151	•1720-5M	67.717	1720	344
365-5M	14.370	365	73	•765-5M	30.118	765	153	•1790-5M	70.472	1790	358
370-5M	14.567	370	74	770-5M	30.315	770	154	•1800-5M	70.866	1800	360
•375-5M	14.764	375	75	775-5M	30.512	775	155	1870-5M	73.622	1870	374
385-5M	15.157	385	77	•790-5M	31.102	790	158	•1895-5M	74.606	1895	379
•400-5M	15.748	400	80	•800-5M	31.496	800	160	•1945-5M	76.575	1945	389
405-5M	15.945	405	81	825-5M	32.480	825	165	•1980-5M	77.953	1980	396
•415-5M	16.339	415	83	•830-5M	32.677	830	166	•2000-5M	78.740	2000	400
•425-5M	16.732	425	85	•835-5M	32.874	835	167	2100-5M	82.677	2100	420
•450-5M	17.717	450	90	•850-5M	33.465	850	170	•2110-5M	83.071	2110	422
•460-5M	18.110	460	92	860-5M	33.858	860	172	•2250-5M	88.583	2250	450
•475-5M	18.701	475	95	•870-5M	34.252	870	174	2350-5M	92.520	2350	470
•480-5M	18.898	480	96	•890-5M	35.039	890	178	•2525-5M	99.409	2525	505
•495-5M	19.488	495	99	900-5M	35.433	900	180	•2760-5M	108.661	2760	552
•500-5M	19.685	500	100	•925-5M	36.417	925	185	•3120-5M	122.835	3120	624
•520-5M	20.472	520	104	935-5M	36.811	935	187	•3170-5M	124.803	3170	634
525-5M	20.669	525	105	940-5M	37.008	940	188	•3430-5M	135.039	3430	686
•535-5M	21.063	535	107	•950-5M	37.402	950	190	3540-5M	139.370	3540	708
550-5M	21.654	550	110	965-5M	37.992	965	193	•3800-5M	149.606	3800	760
•555-5M	21.850	555	111	•975-5M	38.386	975	195				
560-5M	22.047	560	112	•985-5M	38.780	985	197				

Stock lengths are denoted by a •. All other sizes, contact Gates Customer Service for availability.

### 5mm Pitch Stock Belt Widths

Belt Width Code	Belt Width (mm)	Belt Width (in)
09	9	0.354
15	15	0.591
25	25	0.984

## Belt Pitch Selection Guide

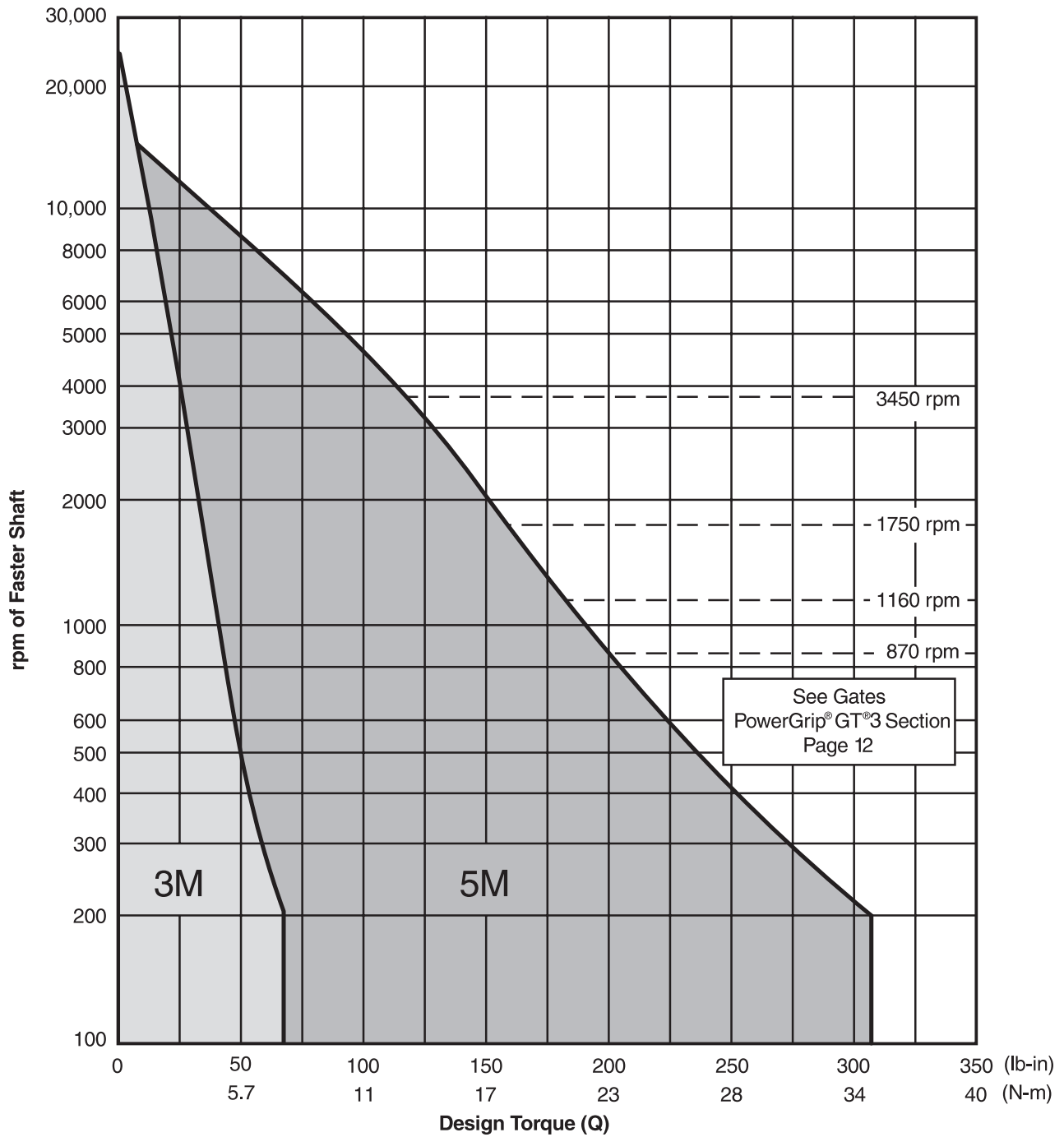

# PowerGrip® HTD® Belt Drives

## Belt Width Selection Tables – 3mm PowerGrip HTD Belts

The following table represents the torque ratings for each belt in its base width at the predetermined number of grooves, pitch diameters and rpm. These ratings must be multiplied by the appropriate width factor and applicable belt length factor to obtain the corrected torque rating. (See Step 4 of Drive Selection Procedure on Page 12).

Belt Width (mm)	6	9	15
Width Multiplier	1.00	1.64	3.03

### Rated Torque (lb-in) For Small Sprocket - 6mm Belt Width

Number of Grooves	10	12	14	16	18	22	26	30	34	38	44	50	56	62	72	80
Pitch Diameter (mm)	9.55	11.46	13.37	15.28	17.19	21.01	24.83	28.65	32.47	36.29	42.02	47.75	53.48	59.21	68.75	76.39
Pitch Diameter (in)	.376	.451	.526	.602	.677	.827	.977	1.128	1.278	1.429	1.654	1.880	2.105	2.331	2.707	3.008
10	3.3	4.0	4.8	5.6	6.5	8.3	10.2	12.3	14.5	16.8	20.5	24.6	27.7	30.7	35.7	39.6
20	3.3	4.0	4.8	5.6	6.5	8.3	10.2	12.3	14.5	16.8	20.5	24.6	27.7	30.7	35.7	39.6
40	3.3	4.0	4.8	5.6	6.5	8.3	10.2	12.3	14.5	16.8	20.5	24.6	27.7	30.7	35.7	39.6
60	3.3	4.0	4.8	5.6	6.5	8.3	10.2	12.3	14.5	16.8	20.5	24.6	27.7	30.7	35.7	39.6
100	3.3	4.0	4.8	5.6	6.5	8.3	10.2	12.3	14.5	16.8	20.5	24.6	27.7	30.7	35.7	39.6
200	3.3	4.0	4.8	5.6	6.5	8.3	10.2	12.3	14.5	16.8	20.5	24.6	27.7	30.7	35.7	39.6
300	3.0	3.7	4.4	5.1	5.9	7.5	9.2	11.1	13.0	15.0	18.3	21.8	24.6	27.3	31.6	35.2
400	2.8	3.4	4.1	4.8	5.5	7.0	8.6	10.3	12.0	13.9	16.9	20.0	22.6	25.0	29.1	32.3
500	2.7	3.3	3.9	4.5	5.2	6.6	8.1	9.7	11.3	13.1	15.8	18.8	21.2	23.4	27.2	30.2
600	2.6	3.1	3.7	4.3	5.0	6.3	7.7	9.2	10.8	12.4	15.0	17.8	20.1	22.2	25.8	28.6
700	2.5	3.0	3.6	4.2	4.8	6.1	7.4	8.9	10.4	11.9	14.4	17.0	19.2	21.2	24.6	27.4
800	2.4	2.9	3.5	4.1	4.7	5.9	7.2	8.6	10.0	11.5	13.9	16.3	18.4	20.4	23.7	26.3
870	2.4	2.9	3.4	4.0	4.6	5.8	7.0	8.4	9.8	11.2	13.5	15.9	18.0	19.9	23.1	25.6
1000	2.3	2.8	3.3	3.9	4.4	5.6	6.8	8.1	9.4	10.8	13.0	15.3	17.2	19.1	22.1	24.6
1160	2.2	2.7	3.2	3.7	4.3	5.4	6.5	7.8	9.1	10.4	12.5	14.6	16.5	18.2	21.2	23.5
1450	2.1	2.6	3.0	3.5	4.0	5.1	6.2	7.3	8.5	9.8	11.7	13.7	15.4	17.1	19.8	22.0
1600	2.0	2.5	3.0	3.4	3.9	5.0	6.0	7.2	8.3	9.5	11.4	13.3	15.0	16.5	19.2	21.3
1750	2.0	2.5	2.9	3.4	3.9	4.9	5.9	7.0	8.1	9.3	11.1	12.9	14.6	16.1	18.7	20.7
2000	1.9	2.4	2.8	3.3	3.7	4.7	5.7	6.7	7.8	8.9	10.7	12.4	14.0	15.4	17.9	19.8
2500	1.9	2.3	2.7	3.1	3.5	4.4	5.4	6.4	7.4	8.4	10.0	11.6	13.0	14.4	16.6	18.4
3000	1.8	2.2	2.6	3.0	3.4	4.2	5.1	6.1	7.0	8.0	9.4	11.0	12.3	13.5	15.6	17.3
3500	1.7	2.1	2.5	2.9	3.3	4.1	4.9	5.8	6.7	7.6	9.0	10.4	11.7	12.8	14.8	16.3
5000	1.6	1.9	2.3	2.6	3.0	3.7	4.5	5.2	6.0	6.8	8.0	9.2	10.2	11.1	12.7	13.8
8000	1.4	1.7	2.0	2.3	2.6	3.3	3.9	4.5	5.1	5.7	6.6	7.3	8.0	8.5	9.1	9.3
10000	1.3	1.6	1.9	2.2	2.5	3.0	3.6	4.1	4.6	5.1	5.7	6.3	6.6	6.8		

### Rated Torque (N-m)

10	.4	.5	.5	.6	.7	.9	1.2	1.4	1.6	1.9	2.3	2.8	3.1	3.5	4.0	4.5
20	.4	.5	.5	.6	.7	.9	1.2	1.4	1.6	1.9	2.3	2.8	3.1	3.5	4.0	4.5
40	.4	.5	.5	.6	.7	.9	1.2	1.4	1.6	1.9	2.3	2.8	3.1	3.5	4.0	4.5
60	.4	.5	.5	.6	.7	.9	1.2	1.4	1.6	1.9	2.3	2.8	3.1	3.5	4.0	4.5
100	.4	.5	.5	.6	.7	.9	1.2	1.4	1.6	1.9	2.3	2.8	3.1	3.5	4.0	4.5
200	.4	.5	.5	.6	.7	.9	1.2	1.4	1.6	1.9	2.3	2.8	3.1	3.5	4.0	4.5
300	.3	.4	.5	.6	.7	.8	1.0	1.2	1.5	1.7	2.1	2.5	2.8	3.1	3.6	4.0
400	.3	.4	.5	.6	.8	.8	1.0	1.2	1.4	1.6	1.9	2.3	2.6	2.8	3.3	3.6
500	.3	.4	.4	.5	.6	.7	.9	1.1	1.3	1.5	1.8	2.1	2.4	2.6	3.1	3.4
600	.3	.4	.4	.5	.6	.7	.9	1.0	1.2	1.4	1.7	2.0	2.3	2.5	2.9	3.2
700	.3	.3	.4	.5	.5	.7	.8	1.0	1.2	1.3	1.6	1.9	2.2	2.4	2.8	3.1
800	.3	.3	.4	.5	.5	.7	.8	1.0	1.1	1.3	1.6	1.8	2.1	2.3	2.7	3.0
870	.3	.3	.4	.4	.5	.7	.8	.9	1.1	1.3	1.5	1.8	2.0	2.2	2.6	2.9
1000	.3	.3	.4	.4	.5	.6	.8	.9	1.1	1.2	1.5	1.7	1.9	2.2	2.5	2.8
1160	.2	.3	.4	.4	.5	.6	.7	.9	1.0	1.2	1.4	1.7	1.9	2.1	2.4	2.7
1450	.2	.3	.3	.4	.5	.6	.7	.8	1.0	1.1	1.3	1.5	1.7	1.9	2.2	2.5
1600	.2	.3	.3	.4	.4	.6	.7	.8	.9	1.1	1.3	1.5	1.7	1.9	2.2	2.4
1750	.2	.3	.3	.4	.4	.5	.7	.8	.9	1.0	1.3	1.5	1.6	1.8	2.1	2.3
2000	.2	.3	.3	.4	.4	.5	.6	.8	.9	1.0	1.2	1.4	1.6	1.7	2.0	2.2
2500	.2	.3	.3	.4	.4	.5	.6	.7	.8	.9	1.1	1.3	1.5	1.6	1.9	2.1
3000	.2	.2	.3	.3	.4	.5	.6	.7	.8	.9	1.1	1.2	1.4	1.5	1.8	1.9
3500	.2	.2	.3	.3	.4	.5	.6	.7	.8	.9	1.0	1.2	1.3	1.5	1.7	1.8
5000	.2	.2	.3	.3	.3	.4	.5	.6	.7	.8	.9	1.0	1.2	1.3	1.4	1.6
8000	.2	.2	.2	.3	.3	.4	.4	.5	.6	.7	.8	.9	.9	1.0	1.0	1.1
10000	.2	.2	.2	.2	.3	.3	.4	.5	.5	.6	.6	.7	.7	.8		

### Length Correction Factor

		0.80	0.90	1.00	1.10	1.20
For Belt Length	From	Length (mm)	144	198	264	408
		# of teeth	48	66	88	136
	To	Length (mm)	195	261	405	597
		# of teeth	65	87	135	199
						603 & up
						201 & up

Shaded area indicates sprocket and rpm that will result in reduced service life. Contact Gates Product Application Engineering for specific recommendations.

# PowerGrip® HTD® Belt Drives

## Belt Width Selection Tables – 5mm PowerGrip HTD Belts

The following table represents the torque ratings for each belt in its base width at the predetermined number of grooves, pitch diameters and rpm. These ratings must be multiplied by the appropriate width factor and applicable belt length factor to obtain the corrected torque rating. (See Step 4 of Drive Selection Procedure on Page 12).

Belt Width (mm)	9	15	25
Width Multiplier	1.00	1.89	3.38

### Rated Torque (lb-in) For Small Sprocket - 9mm Belt Width

Number of Grooves	14	16	18	20	22	24	26	28	32	36	40	44	48	56	64	72
Pitch Diameter (mm)	22.28	25.46	28.65	31.83	35.01	38.20	41.38	44.56	50.93	57.30	63.66	70.03	76.39	89.13	101.86	114.59
Pitch Diameter (in)	<b>0.877</b>	<b>1.003</b>	<b>1.128</b>	<b>1.253</b>	<b>1.379</b>	<b>1.504</b>	<b>1.629</b>	<b>1.754</b>	<b>2.005</b>	<b>2.256</b>	<b>2.506</b>	<b>2.757</b>	<b>3.008</b>	<b>3.509</b>	<b>4.010</b>	<b>4.511</b>
10	19.0	22.3	25.7	29.3	33.0	36.9	40.9	45.1	53.8	63.1	73.0	83.5	94.5	113.3	129.5	145.7
20	19.0	22.3	25.7	29.3	33.0	36.9	40.9	45.1	53.8	63.1	73.0	83.5	94.5	113.3	129.5	145.7
40	19.0	22.3	25.7	29.3	33.0	36.9	40.9	45.1	53.8	63.1	73.0	83.5	94.5	113.3	129.5	145.7
60	19.0	22.3	25.7	29.3	33.0	36.9	40.9	45.1	53.8	63.1	73.0	83.5	94.5	113.3	129.5	145.7
100	19.0	22.3	25.7	29.3	33.0	36.9	40.9	45.1	53.8	63.1	73.0	83.5	94.5	113.3	129.5	145.7
200	19.0	22.3	25.7	29.3	33.0	36.9	40.9	45.1	53.8	63.1	73.0	83.5	94.5	113.3	129.5	145.7
300	17.3	20.2	23.3	26.5	29.9	33.3	36.9	40.6	48.3	56.5	65.2	74.4	84.0	100.4	114.8	129.1
400	16.2	18.9	21.8	24.7	27.8	31.0	34.3	37.7	44.8	52.3	60.2	68.5	77.2	92.2	105.3	118.5
500	15.3	17.9	20.6	23.4	26.3	29.3	32.4	35.6	42.2	49.2	56.5	64.3	72.3	86.2	98.5	110.8
600	14.7	17.2	19.7	22.4	25.1	28.0	30.9	33.9	40.2	46.8	53.7	61.0	68.5	81.7	93.3	104.9
700	14.2	16.5	19.0	21.6	24.2	26.9	29.7	32.6	38.6	44.9	51.5	58.3	65.5	78.0	89.1	100.1
800	13.7	16.0	18.4	20.9	23.4	26.0	28.7	31.5	37.2	43.3	49.6	56.1	63.0	74.9	85.5	96.2
870	13.5	15.7	18.0	20.4	22.9	25.5	28.1	30.8	36.4	42.3	48.4	54.8	61.4	73.0	83.4	93.7
1000	13.0	15.2	17.4	19.8	22.1	24.6	27.1	29.7	35.1	40.7	46.5	52.6	58.9	70.0	79.9	89.8
1160	12.6	14.7	16.8	19.1	21.3	23.7	26.1	28.6	33.7	39.1	44.6	50.4	56.4	66.9	76.3	85.7
1400	12.0	14.0	16.1	18.2	20.4	22.6	24.9	27.2	32.0	37.1	42.3	47.7	53.2	63.1	71.9	80.7
1450	11.9	13.9	15.9	18.0	20.2	22.4	24.6	27.0	31.7	36.7	41.9	47.2	52.7	62.4	71.1	79.8
1600	11.7	13.6	15.6	17.6	19.7	21.8	24.0	26.3	30.9	35.7	40.7	45.8	51.1	60.4	68.9	77.2
1750	11.4	13.3	15.2	17.2	19.2	21.3	23.5	25.6	30.1	34.8	39.6	44.6	49.7	58.7	66.8	74.9
1800	11.3	13.2	15.1	17.1	19.1	21.2	23.3	25.5	29.9	34.5	39.3	44.2	49.2	58.2	66.2	74.1
2000	11.1	12.9	14.7	16.6	18.6	20.6	22.7	24.7	29.0	33.5	38.1	42.8	47.6	56.2	63.9	71.4
2500	10.5	12.2	13.9	15.7	17.6	19.4	21.3	23.3	27.3	31.4	35.6	39.9	44.2	51.9	58.8	65.5
3000	10.0	11.7	13.3	15.0	16.7	18.5	20.3	22.1	25.8	29.7	33.5	37.5	41.5	48.5	54.6	60.5
3600	9.6	11.1	12.7	14.3	15.9	17.6	19.3	21.0	24.4	27.9	31.5	35.1	38.6	44.8	50.1	55.0
5000	8.8	10.2	11.6	13.1	14.5	15.9	17.4	18.9	21.8	24.7	27.6	30.4	33.1	37.4	40.6	43.0
8000	7.8	8.9	10.1	11.2	12.3	13.4	14.4	15.4	17.3	19.0	20.4	21.5	22.3			
10000	7.2	8.2	9.2	10.1	11.0	11.9	12.7	13.4	14.5	15.3						

### Rated Torque (N-m)

10	2.1	2.5	2.9	3.3	3.7	4.2	4.6	5.1	6.1	7.1	8.3	9.4	10.7	12.8	14.6	16.5
20	2.1	2.5	2.9	3.3	3.7	4.2	4.6	5.1	6.1	7.1	8.3	9.4	10.7	12.8	14.6	16.5
40	2.1	2.5	2.9	3.3	3.7	4.2	4.6	5.1	6.1	7.1	8.3	9.4	10.7	12.8	14.6	16.5
60	2.1	2.5	2.9	3.3	3.7	4.2	4.6	5.1	6.1	7.1	8.3	9.4	10.7	12.8	14.6	16.5
100	2.1	2.5	2.9	3.3	3.7	4.2	4.6	5.1	6.1	7.1	8.3	9.4	10.7	12.8	14.6	16.5
200	2.1	2.5	2.9	3.3	3.7	4.2	4.6	5.1	6.1	7.1	8.3	9.4	10.7	12.8	14.6	16.5
300	2.0	2.3	2.6	3.0	3.4	3.8	4.2	4.6	5.5	6.4	7.4	8.4	9.5	11.3	13.0	14.6
400	1.8	2.1	2.5	2.8	3.1	3.5	3.9	4.3	5.1	5.9	6.8	7.7	8.7	10.4	11.9	13.4
500	1.7	2.0	2.3	2.6	3.0	3.3	3.7	4.0	4.8	5.6	6.4	7.3	8.2	9.7	11.1	12.5
600	1.7	1.9	2.2	2.5	2.8	3.2	3.5	3.8	4.5	5.3	6.1	6.9	7.7	9.2	10.5	11.9
700	1.6	1.9	2.1	2.4	2.7	3.0	3.4	3.7	4.4	5.1	5.8	6.6	7.4	8.8	10.1	11.3
800	1.6	1.8	2.1	2.4	2.6	2.9	3.2	3.6	4.2	4.9	5.6	6.3	7.1	8.5	9.7	10.9
870	1.5	1.8	2.0	2.3	2.6	2.9	3.2	3.5	4.1	4.8	5.5	6.2	6.9	8.2	9.4	10.6
1000	1.5	1.7	2.0	2.2	2.5	2.8	3.1	3.4	4.0	4.6	5.3	5.9	6.7	7.9	9.0	10.1
1160	1.4	1.7	1.9	2.2	2.4	2.7	3.0	3.2	3.8	4.4	5.0	5.7	6.4	7.6	8.6	9.7
1400	1.4	1.6	1.8	2.1	2.3	2.6	2.8	3.1	3.6	4.2	4.8	5.4	6.0	7.1	8.1	9.1
1450	1.3	1.6	1.8	2.0	2.3	2.5	2.8	3.0	3.6	4.1	4.7	5.3	6.0	7.0	8.0	9.0
1600	1.3	1.5	1.8	2.0	2.2	2.5	2.7	3.0	3.5	4.0	4.6	5.2	5.8	6.8	7.8	8.7
1750	1.3	1.5	1.7	1.9	2.2	2.4	2.7	2.9	3.4	3.9	4.5	5.0	5.6	6.6	7.6	8.5
1800	1.3	1.5	1.7	1.9	2.2	2.4	2.6	2.9	3.4	3.9	4.4	5.0	5.6	6.6	7.5	8.4
2000	1.3	1.5	1.7	1.9	2.1	2.3	2.6	2.8	3.3	3.8	4.3	4.8	5.4	6.3	7.2	8.1
2500	1.2	1.4	1.6	1.8	2.0	2.2	2.4	2.6	3.1	3.5	4.0	4.5	5.0	5.9	6.6	7.4
3000	1.1	1.3	1.5	1.7	1.9	2.1	2.3	2.5	2.9	3.4	3.8	4.2	4.7	5.5	6.2	6.8
3600	1.1	1.3	1.4	1.6	1.8	2.0	2.2	2.4	2.8	3.2	3.6	4.0	4.4	5.1	5.7	6.2
5000	1.0	1.2	1.3	1.5	1.6	1.8	2.0	2.1	2.5	2.8	3.1	3.4	3.7	4.2	4.6	4.9
8000	.9	1.0	1.1	1.3	1.4	1.5	1.6	1.7	2.0	2.1	2.3	2.4	2.5			
10000	.8	.9	1.0	1.1	1.2	1.3	1.4	1.5	1.6	1.7						

Length Correction Factor		0.80	0.90	1.00	1.10	1.20
For Belt	From	Length (mm)	350	440	555	845
		# of teeth	70	88	111	169
	To	Length (mm)	435	550	840	1090 & up
		# of teeth	87	110	168	220 & up

Shaded area indicates sprocket and rpm that will result in reduced service life. Contact Gates Product Application Engineering for specific recommendations.





## Twin Power Belt Drive Systems

Twin Power Belts are similar in construction to standard synchronous belts, including nylon-faced teeth on both sides. This construction uses essentially the same design parameters as standard synchronous belts. Gates 3mm and 5mm pitch Twin Power PowerGrip® HTD® belts have helically-wound fiberglass tension members embedded in a Neoprene body with the belt teeth faced with a tough wear-resistant nylon fabric. A unique feature of this construction is that Gates Twin Power belts can transmit their full rated load on either the front or back side.

The three principal dimensions, in millimeters, shown below, are used to specify a Twin Power PowerGrip® HTD® belt.:

TP Twin Power	450 Pitch Length	3M Pitch	09 Width
---------------------	------------------------	-------------	-------------

Belt pitch is the distance in millimeters between two adjacent tooth centers as measured on the pitch line of the belt. Belt pitch length is the total length (circumference) in millimeters as measured along the pitch line. The theoretical pitch line of a PowerGrip® HTD® belt lies within the tensile member.

Three principal dimensions of a sprocket — number of grooves, pitch and belt width in millimeters — are used to specify a PowerGrip® HTD® sprocket as shown below:

P22 Number of Grooves	3M Pitch	09 Belt Width
-----------------------------	-------------	---------------------

**NOTE:** For drive design procedure, see Page 24.

Belt tooth to sprocket groove clearance is greater in PowerGrip® HTD® drives than in PowerGrip Timing drives. If the higher torque capacity of PowerGrip® HTD® is required together with minimal backlash characteristics, use PowerGrip® GT®3.

### 3mm Pitch – Reference Dimensions

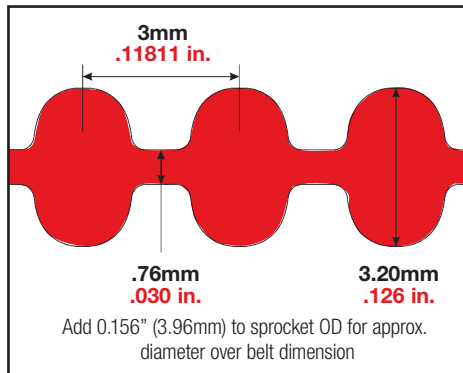

### 5mm Pitch – Reference Dimensions

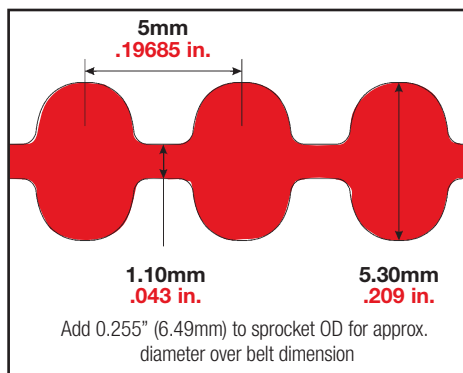

# PowerGrip® HTD® Belt Drives – Twin Power

## PowerGrip HTD Belt Lengths

### 3mm Pitch Belt Lengths

Belt Length Code	Pitch Length		Number of Teeth	Belt Length Code	Pitch Length		Number of Teeth	Belt Length Code	Pitch Length		Number of Teeth
	(mm)	(in)			(mm)	(in)			(mm)	(in)	
TP381-3M	381	15.00	127	TP525-3M	525	20.67	175	TP735-3M	735	28.94	245
TP384-3M	384	15.12	128	TP528-3M	528	20.79	176	TP738-3M	738	29.06	246
TP387-3M	387	15.24	129	TP531-3M	531	20.91	177	TP753-3M	753	29.65	251
TP390-3M	390	15.35	130	TP537-3M	537	21.14	179	TP795-3M	795	31.30	265
TP396-3M	396	15.59	132	TP558-3M	558	21.97	186	TP822-3M	822	32.36	274
TP399-3M	399	15.71	133	TP564-3M	564	22.20	188	TP837-3M	837	32.95	279
TP405-3M	405	15.94	135	TP570-3M	570	22.44	190	TP843-3M	843	33.19	281
TP411-3M	411	16.18	137	TP576-3M	576	22.68	192	TP873-3M	873	34.37	291
TP417-3M	417	16.42	139	TP585-3M	585	23.03	195	TP882-3M	882	34.72	294
TP420-3M	420	16.54	140	TP591-3M	591	23.27	197	TP891-3M	891	35.08	297
TP426-3M	426	16.77	142	TP597-3M	597	23.50	199	TP900-3M	900	35.43	300
TP432-3M	432	17.01	144	TP600-3M	600	23.62	200	TP915-3M	915	36.02	305
TP435-3M	435	17.13	145	TP606-3M	606	23.86	202	TP945-3M	945	37.20	315
TP438-3M	438	17.24	146	TP609-3M	609	23.98	203	TP951-3M	951	37.44	317
TP444-3M	444	17.48	148	TP612-3M	612	24.09	204	TP981-3M	981	38.62	327
TP447-3M	447	17.60	149	TP627-3M	627	24.69	209	TP1002-3M	1002	39.45	334
TP459-3M	459	18.07	153	TP633-3M	633	24.92	211	TP1026-3M	1026	40.39	342
TP468-3M	468	18.43	156	TP639-3M	639	25.16	213	TP1035-3M	1035	40.75	345
TP471-3M	471	18.54	157	TP645-3M	645	25.39	215	TP1062-3M	1062	41.81	354
TP474-3M	474	18.66	158	TP648-3M	648	25.51	216	TP1125-3M	1125	44.29	375
TP480-3M	480	18.90	160	TP654-3M	654	25.75	218	TP1155-3M	1155	45.47	385
TP486-3M	486	19.13	162	TP657-3M	657	25.87	219	TP1191-3M	1191	46.89	397
TP489-3M	489	19.25	163	TP663-3M	663	26.10	221	TP1263-3M	1263	49.72	421
TP492-3M	492	19.37	164	TP669-3M	669	26.34	223	TP1500-3M	1500	59.06	500
TP501-3M	501	19.72	167	TP684-3M	684	26.93	228	TP1512-3M	1512	59.53	504
TP510-3M	510	20.08	170	TP687-3M	687	27.05	229	TP1587-3M	1587	62.48	529
TP513-3M	513	20.20	171	TP696-3M	696	27.40	232	TP1956-3M	1956	77.01	652
TP519-3M	519	20.43	173	TP711-3M	711	27.99	237	TP2004-3M	2004	78.90	668

All sizes are made-to-order. Contact Gates Customer Service for availability.

### 3mm Pitch Stock Belt Widths

Belt Width Code	Belt Width (mm)	Belt Width (in)
06	6	0.236
09	9	0.354
15	15	0.591

### 5mm Pitch Stock Belt Widths

Belt Width Code	Belt Width (mm)	Belt Width (in)
09	9	0.354
15	15	0.591
25	25	0.984

### 5mm Pitch Belt Lengths

Belt Length Code	Pitch Length		Number of Teeth	Belt Length Code	Pitch Length		Number of Teeth	Belt Length Code	Pitch Length		Number of Teeth
	(mm)	(in)			(mm)	(in)			(mm)	(in)	
TP400-5M	400	15.75	80	TP695-5M	695	27.36	139	TP1295-5M	1295	50.98	259
TP415-5M	415	16.34	83	TP710-5M	710	27.95	142	TP1375-5M	1375	54.13	275
TP425-5M	425	16.73	85	TP740-5M	740	29.13	148	TP1420-5M	1420	55.91	284
TP450-5M	450	17.72	90	TP745-5M	745	29.33	149	TP1575-5M	1575	62.01	315
TP460-5M	460	18.11	92	TP765-5M	765	30.12	153	TP1595-5M	1595	62.80	319
TP475-5M	475	18.70	95	TP790-5M	790	31.10	158	TP1635-5M	1635	64.37	327
TP480-5M	480	18.90	96	TP800-5M	800	31.50	160	TP1690-5M	1690	66.54	338
TP495-5M	495	19.49	99	TP830-5M	830	32.68	166	TP1720-5M	1720	67.72	344
TP500-5M	500	19.69	100	TP835-5M	835	32.87	167	TP1790-5M	1790	70.47	358
TP520-5M	520	20.47	104	TP850-5M	850	33.46	170	TP1800-5M	1800	70.87	360
TP535-5M	535	21.06	107	TP870-5M	870	34.25	174	TP1895-5M	1895	74.61	379
TP555-5M	555	21.85	111	TP890-5M	890	35.04	178	TP1945-5M	1945	76.57	389
TP565-5M	565	22.24	113	TP925-5M	925	36.42	185	TP1980-5M	1980	77.95	396
TP580-5M	580	22.83	116	TP950-5M	950	37.40	190	TP2000-5M	2000	78.74	400
TP585-5M	585	23.03	117	TP975-5M	975	38.39	195	TP2110-5M	2110	83.07	422
TP600-5M	600	23.62	120	TP985-5M	985	38.78	197	TP2250-5M	2250	88.58	450
TP615-5M	615	24.21	123	TP1000-5M	1000	39.37	200	TP2525-5M	2525	99.41	505
TP635-5M	635	25.00	127	TP1050-5M	1050	41.34	210	TP2760-5M	2760	108.66	552
TP655-5M	655	25.79	131	TP1115-5M	1115	43.90	223	TP3120-5M	3120	122.83	624
TP665-5M	665	26.18	133	TP1125-5M	1125	44.29	225	TP3170-5M	3170	124.80	634
TP670-5M	670	26.38	134	TP1195-5M	1195	47.05	239	TP3430-5M	3430	135.04	686
TP680-5M	680	26.77	136	TP1250-5M	1250	49.21	250	TP3800-5M	3800	149.61	760
TP685-5M	685	26.97	137	TP1270-5M	1270	50.00	254				

All sizes are made-to-order. Contact Gates Customer Service for availability.



# PowerGrip® HTD® Belt Drives

## Sprocket Specification Tables - 3mm Pitch PowerGrip® HTD® Sprockets

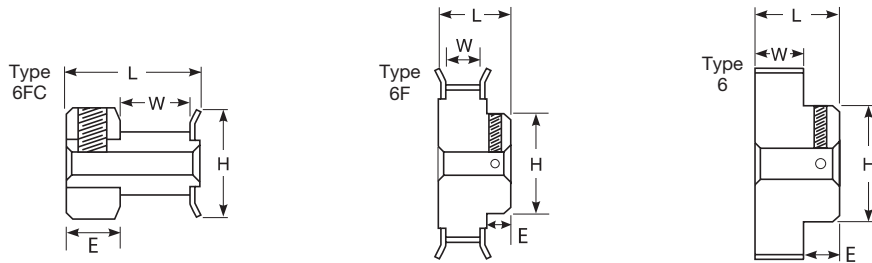

### 6mm (0.236 in) Wide Belts (3M-06)

Sprocket Number	No. of Grooves	Diameter (in)			Design Type	Dimensions (in)						Set Screws**	Wt. (lb)	Material***
		Pitch	OD	Flange Ref.		Plain Bore' (in)								
						W	L	H	E	Min	Max			
P10-3M-06	10	0.376	0.346	0.505	6FC	0.280	0.562	0.505	0.282	0.125	0.125	4-40	0.01	AL
P11-3M-06	11	0.414	0.384	0.530	6FC	0.280	0.562	0.530	0.282	0.125	0.125	4-40	0.01	AL
P12-3M-06	12	0.451	0.421	0.580	6FC	0.280	0.562	0.580	0.282	0.188	0.188	6-40	0.01	AL
P13-3M-06	13	0.489	0.459	0.610	6FC	0.280	0.562	0.610	0.282	0.188	0.188	6-40	0.01	AL
P14-3M-06	14	0.526	0.496	0.635	6FC	0.280	0.562	0.635	0.282	0.188	0.250	6-40	0.01	AL
P15-3M-06	15	0.564	0.534	0.685	6FC	0.280	0.562	0.685	0.282	0.188	0.250	6-40	0.01	AL
P16-3M-06	16	0.602	0.572	0.710	6FC	0.280	0.562	0.710	0.282	0.188	0.250	6-40	0.01	AL
P17-3M-06	17	0.639	0.609	0.740	6FC	0.280	0.562	0.740	0.282	0.188	0.250	6-40	0.02	AL
P18-3M-06	18	0.677	0.647	0.790	6F	0.280	0.688	0.442	0.408	0.250	0.250	8-32	0.01	AL
P19-3M-06	19	0.714	0.684	0.815	6F	0.280	0.688	0.468	0.408	0.250	0.250	8-32	0.02	AL
P20-3M-06	20	0.752	0.722	0.895	6F	0.280	0.688	0.500	0.408	0.250	0.250	8-32	0.02	AL
P22-3M-06	22	0.827	0.797	0.945	6F	0.280	0.688	0.562	0.408	0.250	0.250	8-32	0.02	AL
P24-3M-06	24	0.902	0.872	1.025	6F	0.280	0.688	0.625	0.408	0.250	0.313	8-32	0.03	AL
P25-3M-06	25	0.940	0.910	1.060	6F	0.280	0.688	0.625	0.408	0.250	0.313	8-32	0.03	AL
P26-3M-06	26	0.977	0.947	1.105	6F	0.280	0.688	0.625	0.408	0.250	0.313	8-32	0.03	AL
P28-3M-06	28	1.053	1.023	1.173	6F	0.280	0.688	0.701	0.408	0.250	0.375	8-32	0.04	AL
P30-3M-06	30	1.128	1.098	1.250	6F	0.280	0.688	0.776	0.408	0.250	0.437	8-32	0.05	AL
P32-3M-06	32	1.203	1.173	1.323	6F	0.280	0.688	0.851	0.408	0.250	0.500	8-32	0.05	AL
P34-3M-06	34	1.278	1.248	1.398	6F	0.280	0.719	0.921	0.439	0.250	0.562	8-32	0.07	AL
P36-3M-06	36	1.353	1.323	1.473	6F	0.280	0.719	1.000	0.439	0.250	0.625	8-32	0.08	AL
P38-3M-06	38	1.429	1.399	1.549	6F	0.280	0.719	1.075	0.439	0.250	0.750	8-32	0.09	AL
P40-3M-06	40	1.504	1.474	1.625	6F	0.280	0.719	1.150	0.439	0.250	0.812	8-32	0.10	AL
P44-3M-06	44	1.654	1.624	1.775	6F	0.280	0.719	1.300	0.439	0.250	0.937	8-32	0.12	AL
P48-3M-06	48	1.805	1.775	---	6	0.407	0.734	1.250	0.327	0.313	0.937	8-32	0.13	AL
P50-3M-06	50	1.880	1.850	---	6	0.407	0.734	1.250	0.327	0.313	0.937	8-32	0.14	AL
P56-3M-06	56	2.105	2.075	---	6	0.407	0.734	1.250	0.327	0.313	0.937	8-32	0.16	AL
P60-3M-06	60	2.256	2.226	---	6	0.407	0.734	1.250	0.327	0.313	0.937	8-32	0.18	AL
P62-3M-06	62	2.331	2.301	---	6	0.407	0.734	1.250	0.327	0.313	0.937	8-32	0.19	AL
P72-3M-06	72	2.707	2.677	---	6	0.407	0.734	1.250	0.327	0.313	0.937	8-32	0.25	AL

\*Plain bore style stocked in smallest bore. \*\* 10,11 and 12 groove pulleys supplied with one set screw. All others are supplied with 2 ea. set screws at 90 degrees. \*\*\* Clear Anodize Finish

**NOTE:** See Synchronous Belt Drives – Sprocket Specifications section, Page 74, for a complete table of stock and non-stock sprocket diameters.

For non-standard designs contact Gates Made-To-Order Metals Team at (800)709-6001

# PowerGrip® HTD® Belt Drives

## Sprocket Specification Tables - 3mm Pitch PowerGrip® HTD® Sprockets

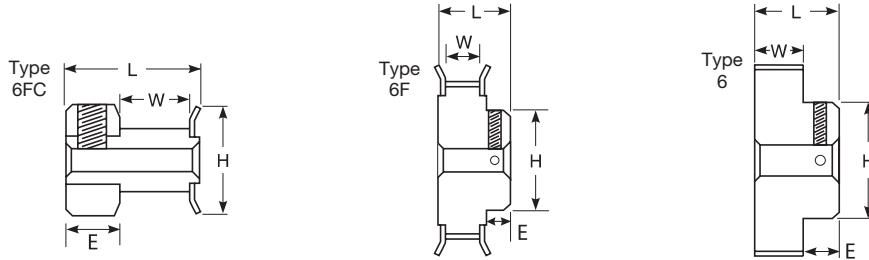

### 9mm (0.354 in) Wide Belts (3M-09)

Sprocket Number	No. of Grooves	Diameter (in)			Design Type	Dimensions (in)						Set Screws**	Wt. (lb)	Material***
		Pitch	OD	Flange Ref.		Plain Bore* (in)								
						W	L	H	E	Min	Max			
P10-3M-09	10	0.376	0.346	0.505	6FC	0.400	0.688	0.505	0.288	0.125	0.125	4-40	0.01	AL
P11-3M-09	11	0.414	0.384	0.530	6FC	0.400	0.688	0.530	0.288	0.125	0.125	4-40	0.01	AL
P12-3M-09	12	0.451	0.421	0.580	6FC	0.400	0.688	0.580	0.288	0.188	0.188	6-40	0.01	AL
P13-3M-09	13	0.489	0.459	0.610	6FC	0.400	0.688	0.610	0.288	0.188	0.188	6-40	0.01	AL
P14-3M-09	14	0.526	0.496	0.635	6FC	0.400	0.688	0.635	0.288	0.188	0.250	6-40	0.01	AL
P15-3M-09	15	0.564	0.534	0.685	6FC	0.400	0.688	0.685	0.288	0.188	0.250	6-40	2.00	AL
P16-3M-09	16	0.602	0.572	0.710	6FC	0.400	0.688	0.710	0.288	0.188	0.250	6-40	0.02	AL
P17-3M-09	17	0.639	0.609	0.740	6FC	0.400	0.688	0.740	0.288	0.188	0.250	6-40	0.02	AL
P18-3M-09	18	0.677	0.647	0.790	6F	0.400	0.812	0.442	0.412	0.250	0.250	8-32	0.02	AL
P19-3M-09	19	0.714	0.684	0.815	6F	0.400	0.812	0.468	0.412	0.250	0.250	8-32	0.02	AL
P20-3M-09	20	0.752	0.722	0.895	6F	0.400	0.812	0.500	0.412	0.250	0.250	8-32	0.02	AL
P22-3M-09	22	0.827	0.797	0.945	6F	0.400	0.812	0.562	0.412	0.250	0.250	8-32	0.03	AL
P24-3M-09	24	0.902	0.872	1.025	6F	0.400	0.812	0.625	0.412	0.250	0.313	8-32	0.03	AL
P25-3M-09	25	0.940	0.910	1.060	6F	0.400	0.812	0.625	0.412	0.250	0.313	8-32	0.04	AL
P26-3M-09	26	0.977	0.947	1.105	6F	0.400	0.812	0.625	0.412	0.250	0.313	8-32	0.04	AL
P28-3M-09	28	1.053	1.023	1.173	6F	0.400	0.812	0.701	0.412	0.250	0.375	8-32	0.05	AL
P30-3M-09	30	1.128	1.098	1.250	6F	0.400	0.812	0.776	0.412	0.250	0.437	8-32	0.05	AL
P32-3M-09	32	1.203	1.173	1.323	6F	0.400	0.812	0.851	0.412	0.250	0.500	8-32	0.07	AL
P34-3M-09	34	1.278	1.248	1.398	6F	0.400	0.843	0.921	0.443	0.250	0.562	8-32	0.08	AL
P36-3M-09	36	1.353	1.323	1.473	6F	0.400	0.843	1.000	0.443	0.250	0.625	8-32	0.09	AL
P38-3M-09	38	1.429	1.399	1.549	6F	0.400	0.843	1.075	0.443	0.250	0.750	8-32	0.10	AL
P40-3M-09	40	1.504	1.474	1.625	6F	0.400	0.843	1.150	0.443	0.250	0.812	8-32	0.11	AL
P44-3M-09	44	1.654	1.624	1.775	6F	0.400	0.843	1.300	0.443	0.250	0.937	8-32	0.14	AL
P48-3M-09	48	1.805	1.775	---	6	0.500	0.875	1.250	0.375	0.313	0.937	8-32	0.16	AL
P50-3M-09	50	1.880	1.850	---	6	0.500	0.875	1.250	0.375	0.313	0.937	8-32	0.18	AL
P56-3M-09	56	2.105	2.075	---	6	0.500	0.875	1.250	0.375	0.313	0.937	8-32	0.20	AL
P60-3M-09	60	2.256	2.226	---	6	0.500	0.875	1.250	0.375	0.313	0.937	8-32	0.22	AL
P62-3M-09	62	2.331	2.301	---	6	0.500	0.875	1.250	0.375	0.313	0.937	8-32	0.23	AL
P72-3M-09	72	2.707	2.677	---	6	0.500	0.875	1.250	0.375	0.313	0.937	8-32	0.30	AL

\*Plain bore style stocked in smallest bore. \*\* 10,11 and 12 groove pulleys supplied with one set screw. All others are supplied with 2 ea. set screws at 90 degrees. \*\*\* Clear Anodize Finish

**NOTE:** See Synchronous Belt Drives – Sprocket Specifications section, Page 74, for a complete table of stock and non-stock sprocket diameters.

For non-standard designs contact Gates Made-To-Order Metals Team at (800)709-6001

# PowerGrip® HTD® Belt Drives

## Sprocket Specification Tables - 5mm PowerGrip® HTD® Sprockets

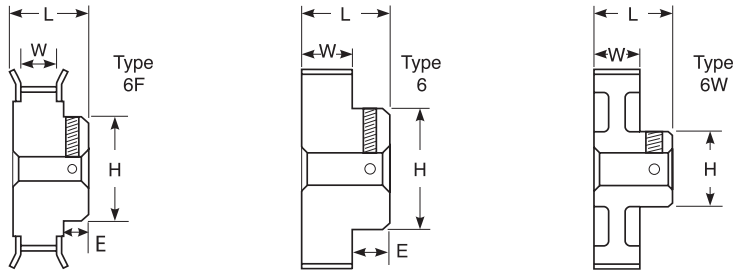

### 9mm (0.354 in) Wide Belts (5M-09)

Sprocket Number	No. of Grooves	Diameter (in)			Design Type	Dimensions (in)						Set Screws**	Wt. (lb)	Material***
		Pitch	OD	Flange Ref.		Plain Bore* (in)		W	L	H	E			
						Min	Max							
P12-5M-09	12	0.752	0.707	0.875	6F	0.420	0.796	0.438	0.376	0.250	0.250	8-32	0.02	AL
P13-5M-09	13	0.815	0.770	0.938	6F	0.420	0.796	0.500	0.376	0.250	0.250	8-32	0.02	AL
P14-5M-09	14	0.877	0.832	1.000	6F	0.420	0.796	0.500	0.376	0.250	0.250	8-32	0.03	AL
P15-5M-09	15	0.940	0.895	1.063	6F	0.420	0.796	0.563	0.376	0.250	0.250	8-32	0.03	AL
P16-5M-09	16	1.003	0.958	1.094	6F	0.420	0.796	0.563	0.376	0.250	0.313	8-32	0.04	AL
P17-5M-09	17	1.065	1.020	1.188	6F	0.420	0.796	0.625	0.376	0.250	0.313	8-32	0.04	AL
P18-5M-09	18	1.128	1.083	1.250	6F	0.420	0.796	0.688	0.376	0.250	0.375	8-32	0.05	AL
P19-5M-09	19	1.191	1.146	1.313	6F	0.420	0.796	0.750	0.376	0.250	0.437	8-32	0.06	AL
P20-5M-09	20	1.253	1.208	1.375	6F	0.420	0.796	0.813	0.376	0.250	0.500	8-32	0.06	AL
P22-5M-09	22	1.379	1.334	1.500	6F	0.420	0.796	0.938	0.376	0.250	0.625	8-32	0.08	AL
P24-5M-09	24	1.504	1.459	1.625	6F	0.420	0.859	1.000	0.439	0.250	0.687	8-32	0.10	AL
P25-5M-09	25	1.566	1.521	1.688	6F	0.420	0.859	1.000	0.439	0.250	0.687	8-32	0.11	AL
P26-5M-09	26	1.629	1.584	1.750	6F	0.420	0.859	1.063	0.439	0.250	0.750	8-32	0.12	AL
P28-5M-09	28	1.754	1.709	1.875	6F	0.420	0.859	1.188	0.439	0.250	0.875	8-32	0.14	AL
P30-5M-09	30	1.880	1.835	2.000	6F	0.420	0.859	1.188	0.439	0.250	0.875	8-32	0.16	AL
P32-5M-09	32	2.005	1.960	2.125	6F	0.420	0.859	1.250	0.439	0.250	0.937	8-32	0.18	AL
P34-5M-09	34	2.130	2.085	2.250	6F	0.420	0.859	1.375	0.439	0.250	1.062	8-32	0.21	AL
P36-5M-09	36	2.256	2.211	---	6	0.546	0.937	1.500	0.391	0.313	1.062	8-32	0.25	AL
P38-5M-09	38	2.381	2.336	---	6	0.546	0.937	1.500	0.391	0.313	1.187	8-32	0.28	AL
P40-5M-09	40	2.506	2.461	---	6	0.546	0.937	1.500	0.391	0.313	1.187	8-32	0.30	AL
P44-5M-09	44	2.757	2.712	---	6	0.546	0.937	1.500	0.391	0.313	1.187	8-32	0.35	AL
P48-5M-09	48	3.008	2.963	---	6	0.546	0.937	1.500	0.391	0.375	1.187	10-32	0.40	AL
P50-5M-09	50	3.133	3.088	---	6	0.546	0.937	1.500	0.391	0.375	1.187	10-32	0.43	AL
P56-5M-09	56	3.509	3.464	---	6	0.546	0.937	1.500	0.391	0.375	1.187	10-32	0.54	AL
P60-5M-09	60	3.760	3.715	---	6	0.546	0.937	1.500	0.391	0.375	1.187	10-32	0.62	AL
P62-5M-09	62	3.885	3.840	---	6	0.546	0.937	1.500	0.391	0.375	1.187	10-32	0.64	AL
P70-5M-09	70	4.386	4.341	---	6	0.546	0.937	1.500	0.391	0.375	1.187	10-32	0.80	AL
P72-5M-09	72	4.511	4.466	---	6	0.546	0.937	1.500	0.391	0.375	1.187	10-32	0.84	AL

\*Plain bore style stocked in smallest bore. \*\* 10,11 and 12 groove pulleys supplied with one set screw. All others are supplied with 2 ea. set screws at 90 degrees. \*\*\* Clear Anodize Finish

**NOTE:** See Synchronous Belt Drives – Sprocket Specifications section, Page 74, for a complete table of stock and non-stock sprocket diameters.

For non-standard designs contact Gates Made-To-Order Metals Team at (800)709-6001

# PowerGrip® HTD® Belt Drives

## Sprocket Specification Tables - 5mm PowerGrip® HTD® Sprockets

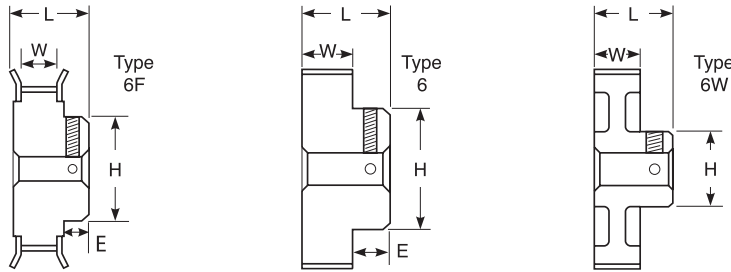

### 15mm (0.591 in) Wide Belts (5M-15)

Sprocket Number	No. of Grooves	Diameter (in)			Design Type	Dimensions (in)						Set Screws**	Wt. (lb)	Material***
		Pitch	OD	Flange Ref.		W	L	H	E	Plain Bore* (in)				
										Min	Max			
P12-5M-15	12	0.752	0.707	0.875	6F	0.547	1.031	0.438	0.484	0.250	0.250	8-32	0.02	AL
P13-5M-15	13	0.815	0.770	0.938	6F	0.547	1.031	0.500	0.484	0.250	0.250	8-32	0.03	AL
P14-5M-15	14	0.877	0.832	1.000	6F	0.547	1.031	0.500	0.484	0.250	0.250	8-32	0.04	AL
P15-5M-15	15	0.940	0.895	1.063	6F	0.547	1.031	0.563	0.484	0.250	0.250	8-32	0.04	AL
P16-5M-15	16	1.003	0.958	1.094	6F	0.547	1.031	0.563	0.484	0.250	0.313	8-32	0.05	AL
P17-5M-15	17	1.065	1.020	1.188	6F	0.547	1.031	0.625	0.484	0.250	0.313	8-32	0.06	AL
P18-5M-15	18	1.128	1.083	1.250	6F	0.547	1.031	0.688	0.484	0.250	0.375	8-32	0.07	AL
P19-5M-15	19	1.191	1.146	1.313	6F	0.547	1.031	0.750	0.484	0.250	0.437	8-32	0.08	AL
P20-5M-15	20	1.253	1.208	1.375	6F	0.547	1.031	0.813	0.484	0.250	0.500	8-32	0.08	AL
P22-5M-15	22	1.379	1.334	1.500	6F	0.547	1.031	0.938	0.484	0.250	0.625	8-32	0.11	AL
P24-5M-15	24	1.504	1.459	1.625	6F	0.547	1.094	1.000	0.547	0.250	0.687	8-32	0.13	AL
P25-5M-15	25	1.566	1.521	1.688	6F	0.547	1.094	1.000	0.547	0.250	0.687	8-32	0.14	AL
P26-5M-15	26	1.629	1.584	1.750	6F	0.547	1.094	1.063	0.547	0.250	0.750	8-32	0.16	AL
P28-5M-15	28	1.754	1.709	1.875	6F	0.547	1.094	1.188	0.547	0.250	0.875	8-32	0.18	AL
P30-5M-15	30	1.880	1.835	2.000	6F	0.547	1.094	1.188	0.547	0.250	0.875	8-32	0.21	AL
P32-5M-15	32	2.005	1.960	2.125	6F	0.547	1.094	1.250	0.547	0.250	0.937	8-32	0.24	AL
P34-5M-15	34	2.130	2.085	2.250	6F	0.547	1.094	1.375	0.547	0.250	1.062	8-32	0.28	AL
P36-5M-15	36	2.256	2.211	---	6	0.781	1.187	1.500	0.406	0.313	1.062	8-32	0.33	AL
P38-5M-15	38	2.381	2.336	---	6	0.781	1.187	1.500	0.406	0.313	1.187	8-32	0.36	AL
P40-5M-15	40	2.506	2.461	---	6	0.781	1.187	1.500	0.406	0.313	1.187	8-32	0.40	AL
P44-5M-15	44	2.757	2.712	---	6	0.781	1.187	1.500	0.406	0.313	1.187	8-32	0.47	AL
P48-5M-15	48	3.008	2.963	---	6	0.781	1.187	1.500	0.406	0.375	1.187	10-32	0.58	AL
P50-5M-15	50	3.133	3.088	---	6	0.781	1.187	1.500	0.406	0.375	1.187	10-32	0.62	AL
P56-5M-15	56	3.509	3.464	---	6	0.781	1.187	1.500	0.406	0.375	1.187	10-32	0.74	AL
P60-5M-15	60	3.760	3.715	---	6	0.781	1.187	1.500	0.406	0.375	1.187	10-32	0.84	AL
P62-5M-15	62	3.885	3.840	---	6	0.781	1.187	1.500	0.406	0.375	1.187	10-32	0.91	AL
P70-5M-15	70	4.386	4.341	---	6	0.781	1.187	1.500	0.406	0.375	1.187	10-32	1.14	AL
P72-5M-15	72	4.511	4.466	---	6	0.781	1.187	1.500	0.406	0.375	1.187	10-32	1.21	AL

\*Plain bore style stocked in smallest bore. \*\* 10, 11 and 12 groove pulleys supplied with one set screw. All others are supplied with 2 ea. set screws at 90 degrees. \*\*\* Clear Anodize Finish

**NOTE:** See Synchronous Belt Drives – Sprocket Specifications section, Page 74, for a complete table of stock and non-stock sprocket diameters.

For non-standard designs contact Gates Made-To-Order Metals Team at (800)709-6001



# PowerGrip® Timing Belt Drives

## Single Sided Belt Drive Systems

PowerGrip® Timing Belt drives operate on the tooth-grip principle, with the molded teeth of the belt designed to make positive engagement with the matching grooves on the pulleys. Gates PowerGrip® Timing belts have helically-wound fiberglass tension members embedded in a Neoprene body with the belt teeth faced with a tough wear-resistant nylon fabric.

The three principal dimensions in inches, shown below, are used to specify a timing belt.

<b>330</b>	<b>XL</b>	<b>025</b>
<b>33.0" Pitch Length</b>	<b>.200" Pitch</b>	<b>.25" Wide</b>

Belt pitch is the distance in inches between two adjacent tooth centers as measured on the pitch line of the belt. Belt pitch length is the total length (circumference) in inches as measured along the pitch line. The theoretical pitch line of a Timing belt lies within the tensile member.

The three principal dimensions used to specify a pulley—number of grooves, pitch and belt width in inches—are shown below.

<b>20</b>	<b>XL</b>	<b>025</b>
<b>Number of grooves</b>	<b>Pitch</b>	<b>Belt Width (0.25")</b>

**NOTE:** For drive design procedure, see page 12. When ordering MXL Timing belts, please specify pitch and number of teeth.

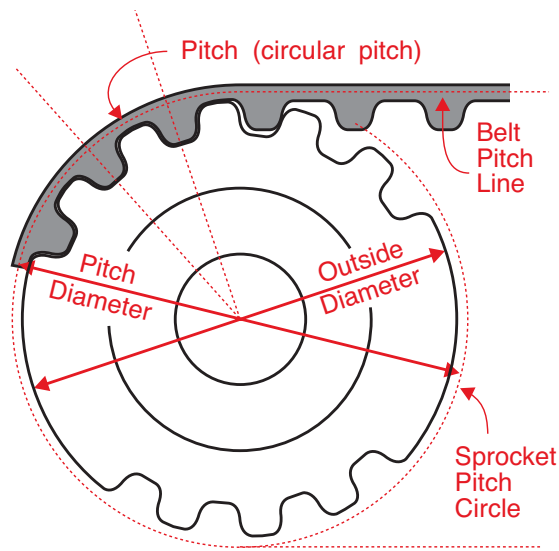

### MXL Pitch – Reference Dimensions

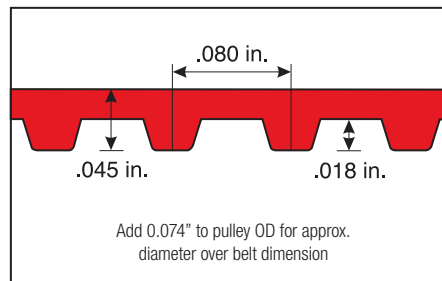

### XL Pitch – Reference Dimensions

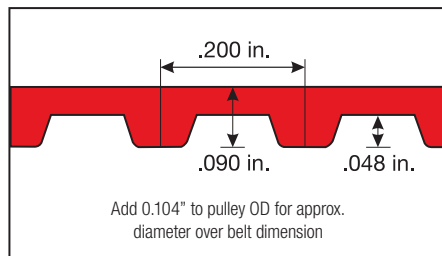

# PowerGrip® Timing Belt Drives

## PowerGrip Belt Lengths and Widths

MXL (.080 in) Belt Lengths														
Description	Pitch Length (in)	No. of Teeth	Description	Pitch Length (in)	No. of Teeth	Description	Pitch Length (in)	No. of Teeth	Description	Pitch Length (in)	No. of Teeth	Description	Pitch Length (in)	No. of Teeth
29MXL	2.880	36	• 62MXL	6.160	77	94MXL	9.440	118	• 160MXL	16.000	200	286MXL	28.640	358
• 32MXL	3.200	40	• 63MXL	6.320	79	• 96MXL	9.600	120	• 166MXL	16.640	208	288MXL	28.800	360
• 34MXL	3.360	42	• 64MXL	6.400	80	98MXL	9.760	122	• 168MXL	16.800	210	• 297MXL	29.680	371
• 36MXL	3.600	45	65MXL	6.480	81	• 98MXL	9.840	123	• 170MXL	16.960	212	• 298MXL	29.760	372
• 38MXL	3.760	47	66MXL	6.560	82	• 100MXL	10.000	125	• 177MXL	17.680	221	312MXL	31.200	390
• 40MXL	4.000	50	• 66MXL	6.640	83	• 101MXL	10.080	126	• 178MXL	17.760	222	• 320MXL	32.000	400
42MXL	4.240	53	67MXL	6.720	84	102MXL	10.160	127	• 180MXL	18.000	225	326MXL	32.640	408
• 43MXL	4.320	54	• 68MXL	6.800	85	103MXL	10.320	129	183MXL	18.320	229	• 330MXL	32.960	412
• 44MXL	4.400	55	• 69MXL	6.960	87	• 104MXL	10.400	130	• 184MXL	18.400	230	336MXL	33.600	420
• 45MXL	4.480	56	• 70MXL	7.040	88	• 106MXL	10.560	132	186MXL	18.560	232	• 339MXL	33.920	424
46MXL	4.560	57	• 72MXL	7.200	90	107MXL	10.720	134	188MXL	18.800	235	340MXL	34.000	425
46MXL	4.640	58	• 74MXL	7.360	92	111MXL	11.120	139	• 196MXL	19.600	245	345MXL	34.480	431
• 47MXL	4.720	59	74MXL	7.440	93	• 112MXL	11.200	140	• 198MXL	19.840	248	• 347MXL	34.720	434
• 48MXL	4.800	60	• 75MXL	7.520	94	• 115MXL	11.520	144	199MXL	19.920	249	• 348MXL	34.800	435
49MXL	4.880	61	• 76MXL	7.600	95	116MXL	11.600	145	• 200MXL	20.000	250	352MXL	35.200	440
50MXL	5.040	63	78MXL	7.760	97	• 120MXL	12.000	150	201MXL	20.080	251	362MXL	36.240	453
• 51MXL	5.120	64	• 80MXL	8.000	100	• 122MXL	12.240	153	205MXL	20.480	256	370MXL	37.040	463
• 52MXL	5.200	65	81MXL	8.080	101	• 124MXL	12.400	155	• 208MXL	20.800	260	380MXL	38.000	475
• 53MXL	5.360	67	• 81MXL	8.160	102	126MXL	12.640	158	• 212MXL	21.200	265	• 390MXL	38.960	487
54MXL	5.440	68	• 82MXL	8.240	103	128MXL	12.800	160	214MXL	21.360	267	390MXL	39.040	488
55MXL	5.520	69	84MXL	8.400	105	• 132MXL	13.200	165	• 224MXL	22.400	280	• 398MXL	39.840	498
• 56MXL	5.600	70	• 84MXL	8.480	106	• 133MXL	13.280	166	• 236MXL	23.600	295	400MXL	40.000	500
• 57MXL	5.680	71	• 85MXL	8.560	107	• 136MXL	13.600	170	238MXL	23.840	298	404MXL	40.400	505
• 58MXL	5.760	72	• 86MXL	8.640	108	• 140MXL	14.000	175	• 240MXL	24.000	300	426MXL	42.560	532
58MXL	5.840	73	• 87MXL	8.720	109	144MXL	14.400	180	• 252MXL	25.200	315	437MXL	43.680	546
• 59MXL	5.920	74	• 88MXL	8.800	110	• 147MXL	14.720	184	254MXL	25.440	318	474MXL	47.360	592
60MXL	6.000	75	• 90MXL	8.960	112	• 152MXL	15.200	190	274MXL	27.440	343	• 480MXL	48.000	600
• 61MXL	6.080	76	• 91MXL	9.120	114	• 156MXL	15.600	195	• 278MXL	27.760	347	• 490MXL	48.960	612
												• 518MXL	51.840	648

Stock Lengths are denoted by a •. All other sizes, contact Gates Customer Service for availability.

MXL Stock Belt Widths	
Belt Width Code	Belt Width (in)
012	1/8 (0.125)
019	3/16 (0.187)
025	1/4 (0.250)



# PowerGrip® Timing Belt Drives

## PowerGrip Belt Lengths and Widths - Continued

### XL (.200 in) Belt Lengths

Description	Pitch Length (in)	Number of Teeth	Description	Pitch Length (in)	Number of Teeth	Description	Pitch Length (in)	Number of Teeth	Description	Pitch Length (in)	Number of Teeth	Description	Pitch Length (in)	Number of Teeth	Description	Pitch Length (in)	Number of Teeth
• 42XL	4.200	21	• 106XL	10.600	53	• 160XL	16.000	80	• 214XL	21.400	107	• 296XL	29.600	148	434XL	43.400	217
• 50XL	5.000	25	• 108XL	10.800	54	• 162XL	16.200	81	• 218XL	21.800	109	• 300XL	30.000	150	• 438XL	43.800	219
• 54XL	5.400	27	• 110XL	11.000	55	• 164XL	16.400	82	• 220XL	22.000	110	• 306XL	30.600	153	• 444XL	44.400	222
• 56XL	5.600	28	• 112XL	11.200	56	• 166XL	16.600	83	• 222XL	22.200	111	• 310XL	31.000	155	• 450XL	45.000	225
• 58XL	5.800	29	• 114XL	11.400	57	• 168XL	16.800	84	• 226XL	22.600	113	• 316XL	31.600	158	• 454XL	45.400	227
• 60XL	6.000	30	• 116XL	11.600	58	• 170XL	17.000	85	• 228XL	22.800	114	• 320XL	32.000	160	• 460XL	46.000	230
• 62XL	6.200	31	• 118XL	11.800	59	• 172XL	17.200	86	• 230XL	23.000	115	• 322XL	32.200	161	• 468XL	46.800	234
• 64XL	6.400	32	• 120XL	12.000	60	• 174XL	17.400	87	• 232XL	23.200	116	• 330XL	33.000	165	• 480XL	48.000	240
• 66XL	6.600	33	• 122XL	12.200	61	• 176XL	17.600	88	• 234XL	23.400	117	• 338XL	33.800	169	490XL	49.000	245
• 68XL	6.800	34	• 124XL	12.400	62	• 178XL	17.800	89	• 236XL	23.600	118	• 340XL	34.000	170	• 492XL	49.200	246
• 70XL	7.000	35	• 126XL	12.600	63	• 180XL	18.000	90	• 240XL	24.000	120	• 344XL	34.400	172	• 498XL	49.800	249
• 72XL	7.200	36	• 128XL	12.800	64	• 182XL	18.200	91	• 244XL	24.400	122	• 348XL	34.800	174	• 500XL	50.000	250
• 74XL	7.400	37	• 130XL	13.000	65	• 184XL	18.400	92	• 246XL	24.600	123	• 350XL	35.000	175	• 506XL	50.600	253
• 76XL	7.600	38	• 132XL	13.200	66	• 186XL	18.600	93	• 250XL	25.000	125	352XL	35.200	176	• 524XL	52.400	262
• 78XL	7.800	39	• 134XL	13.400	67	• 188XL	18.800	94	• 254XL	25.400	127	• 362XL	36.200	181	540XL	54.000	270
• 80XL	8.000	40	• 136XL	13.600	68	• 190XL	19.000	95	• 258XL	25.800	129	• 370XL	37.000	185	554XL	55.400	277
• 82XL	8.200	41	• 138XL	13.800	69	• 192XL	19.200	96	• 260XL	26.000	130	372XL	37.200	186	• 570XL	57.000	285
• 84XL	8.400	42	• 140XL	14.000	70	• 194XL	19.400	97	• 262XL	26.200	131	• 380XL	38.000	190	• 580XL	58.000	290
• 86XL	8.600	43	• 142XL	14.200	71	196XL	19.600	98	• 264XL	26.400	132	382XL	38.200	191	• 592XL	59.200	296
• 88XL	8.800	44	• 144XL	14.400	72	198XL	19.800	99	• 266XL	26.600	133	• 384XL	38.400	192	• 612XL	61.200	306
• 90XL	9.000	45	• 146XL	14.600	73	• 200XL	20.000	100	• 268XL	26.800	134	• 390XL	39.000	195	• 630XL	63.000	315
• 92XL	9.200	46	• 148XL	14.800	74	• 202XL	20.200	101	• 270XL	27.000	135	392XL	39.200	196	• 672XL	67.200	336
• 94XL	9.400	47	• 150XL	15.000	75	• 204XL	20.400	102	• 274XL	27.400	137	• 400XL	40.000	200	690XL	69.000	345
• 96XL	9.600	48	• 152XL	15.200	76	• 206XL	20.600	103	• 280XL	28.000	140	404XL	40.400	202	736XL	73.600	368
• 98XL	9.800	49	• 154XL	15.400	77	208XL	20.800	104	284XL	28.400	142	• 412XL	41.200	206	• 770XL	77.000	385
• 100XL	10.000	50	• 156XL	15.600	78	• 210XL	21.000	105	• 286XL	28.600	143	• 420XL	42.000	210	• 850XL	85.000	425
• 102XL	10.200	51	• 158XL	15.800	79	• 212XL	21.200	106	• 290XL	29.000	145	• 424XL	42.400	212			
												• 432XL	43.200	216			

Stock Lengths are denoted by a •. All other sizes, contact Gates Customer Service for availability.

### XL Stock Belt Widths

Belt Width Code	Belt Width (in)
025	1/4 (0.250)
037	3/8 (0.375)

## Belt Pitch Selection Guide

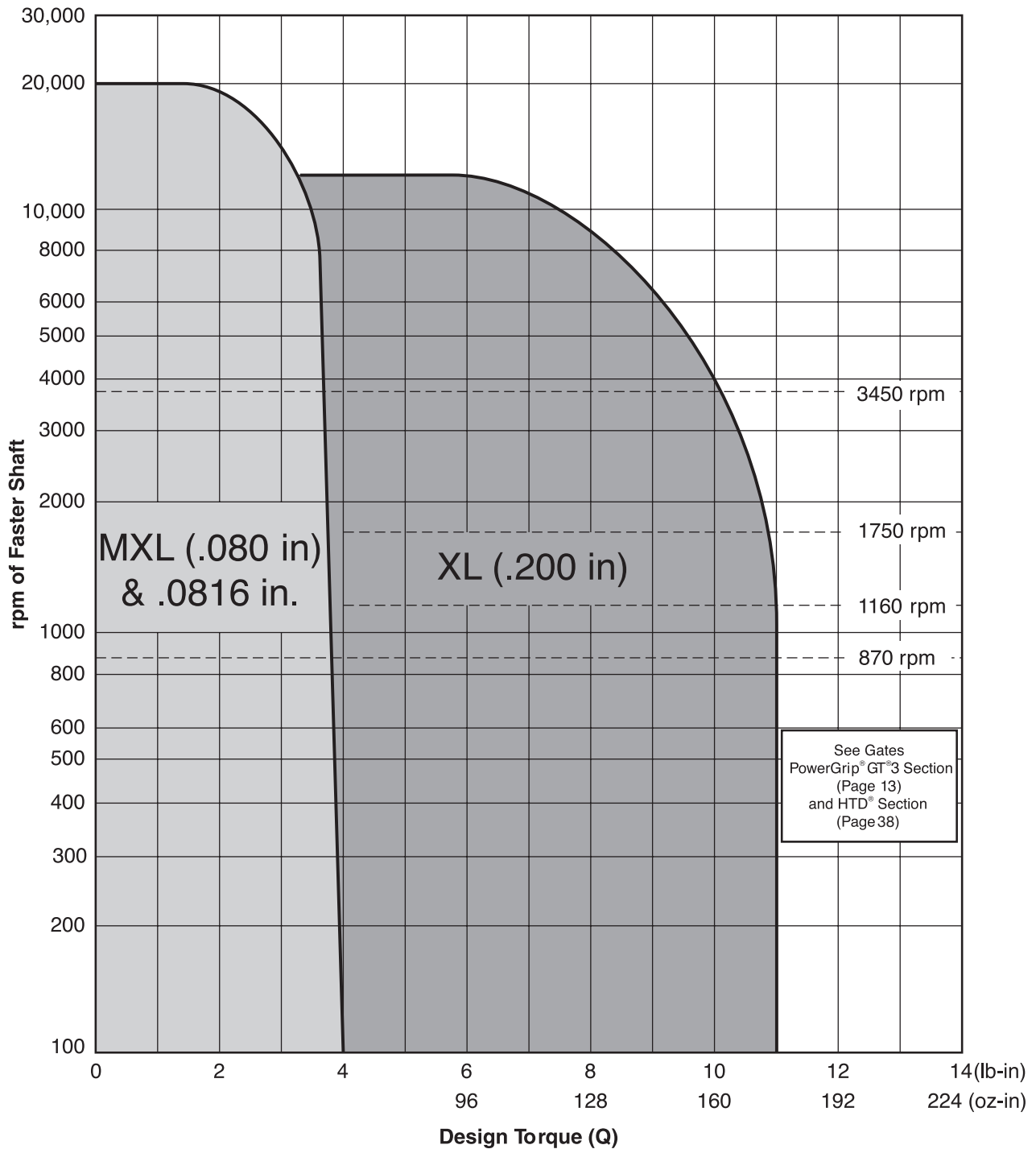

# PowerGrip® Timing Belt Drives

## Belt Width Selection Tables – MXL (.080 in)

The following table represents the torque ratings for each belt in its base width at the predetermined number of grooves, pitch diameters and rpm. These ratings must be multiplied by the appropriate width factor and applicable belt length factor to obtain the corrected torque rating. (See Step 4 of Drive Selection Procedure on Page 12).

Rated Torque (oz-in) For Small Sprocket - 1/8 in. Top Width																					
Number of Grooves	10	11	12	14	15	16	18	20	21	22	24	28	30	32	36	40	42	44	48	60	
Pitch (mm)	6.48	7.11	7.77	9.07	9.70	10.34	11.63	12.93	13.59	14.22	15.52	18.11	19.41	20.70	23.29	25.88	27.18	28.45	31.04	38.81	
Diameter (in)	<b>.255</b>	<b>.280</b>	<b>.306</b>	<b>.357</b>	<b>.382</b>	<b>.407</b>	<b>.458</b>	<b>.509</b>	<b>.535</b>	<b>.560</b>	<b>.611</b>	<b>.713</b>	<b>.764</b>	<b>.815</b>	<b>.917</b>	<b>1.019</b>	<b>1.070</b>	<b>1.120</b>	<b>1.222</b>	<b>1.528</b>	
rpm of Faster Shaft	10	4.61	5.06	5.53	6.45	6.91	7.36	8.28	9.20	9.67	10.1	11.0	12.9	13.8	14.7	16.6	18.4	19.3	20.2	22.1	27.6
	100	4.61	5.06	5.53	6.45	6.91	7.36	8.28	9.20	9.67	10.1	11.0	12.9	13.8	14.7	16.6	18.4	19.3	20.2	22.1	27.6
	1000	4.61	5.06	5.53	6.45	6.91	7.36	8.28	9.20	9.67	10.1	11.0	12.9	13.8	14.7	16.6	18.4	19.3	20.2	22.1	27.6
	2000	4.61	5.06	5.53	6.45	6.90	7.36	8.28	9.20	9.67	10.1	11.0	12.9	13.8	14.7	16.6	18.4	19.3	20.2	22.0	27.5
	2500	4.61	5.06	5.53	6.45	6.90	7.35	8.28	9.20	9.66	10.1	11.0	12.9	13.8	14.7	16.5	18.4	19.3	20.2	22.0	27.4
	3000	4.61	5.06	5.53	6.45	6.90	7.35	8.27	9.19	9.66	10.1	11.0	12.9	13.8	14.7	16.5	18.3	19.2	20.1	21.9	27.3
	3500	4.61	5.06	5.53	6.45	6.90	7.35	8.27	9.19	9.66	10.1	11.0	12.8	13.8	14.7	16.5	18.3	19.2	20.1	21.9	27.2
	5000	4.61	5.06	5.53	6.44	6.89	7.34	8.26	9.17	9.64	10.1	11.0	12.8	13.7	14.6	16.4	18.2	19.1	19.9	21.7	26.8
	8000	4.60	5.05	5.52	6.43	6.87	7.32	8.22	9.12	9.58	10.0	10.9	12.7	13.5	14.4	16.1	17.8	18.6	19.4	21.0	25.5
	10000	4.59	5.04	5.51	6.41	6.85	7.30	8.19	9.08	9.53	9.96	10.8	12.6	13.4	14.2	15.9	17.4	18.2	18.9	20.4	24.3
	12000	4.59	5.03	5.49	6.39	6.83	7.27	8.15	9.03	9.47	9.89	10.7	12.4	13.2	14.0	15.5	17.0	17.7	18.4	19.6	22.8
	<b>Belt Width (in)</b>		<b>1/8</b>	<b>3/16</b>	<b>1/4</b>	<b>5/16</b>	<b>3/8</b>	<b>7/16</b>	<b>1/2</b>												
Width Multiplier		1.00	1.66	2.33	2.84	3.50	4.18	4.86													

## Belt Width Selection Tables – XL (.200 in) Belts

Rated Torque (lb-in) For Small Sprocket - 1/4 in. Top Width														
Number of Grooves	10	11	12	14	15	16	18	20	21	22	24	28	30	
Pitch (mm)	16.18	17.78	19.41	22.63	24.26	25.883	29.11	32.33	33.96	35.59	38.81	45.29	48.51	
Diameter (in)	<b>.637</b>	<b>.700</b>	<b>.764</b>	<b>.891</b>	<b>.955</b>	<b>1.019</b>	<b>1.146</b>	<b>1.273</b>	<b>1.337</b>	<b>1.401</b>	<b>1.528</b>	<b>1.783</b>	<b>1.910</b>	
rpm of Faster Shaft	10	2.32	2.55	2.78	3.24	3.47	3.71	4.17	4.63	4.86	5.09	5.56	6.48	6.95
	100	2.32	2.55	2.78	3.24	3.47	3.71	4.17	4.63	4.86	5.09	5.56	6.48	6.95
	500	2.32	2.55	2.78	3.24	3.47	3.70	4.17	4.63	4.86	5.09	5.55	6.48	6.94
	1000	2.32	2.54	2.78	3.24	3.47	3.70	4.16	4.62	4.86	5.09	5.55	6.47	6.93
	1160	2.32	2.54	2.78	3.24	3.47	3.70	4.16	4.62	4.85	5.08	5.54	6.46	6.92
	1450	2.31	2.54	2.78	3.24	3.47	3.70	4.16	4.62	4.85	5.08	5.54	6.45	6.90
	1600	2.31	2.54	2.78	3.24	3.47	3.70	4.16	4.61	4.84	5.07	5.53	6.44	6.90
	1750	2.31	2.54	2.77	3.23	3.47	3.70	4.15	4.61	4.84	5.07	5.53	6.44	6.89
	2000	2.31	2.54	2.77	3.23	3.46	3.69	4.15	4.61	4.84	5.06	5.52	6.42	6.87
	2500	2.31	2.54	2.77	3.23	3.46	3.69	4.14	4.59	4.82	5.05	5.49	6.38	6.82
	3000	2.31	2.54	2.77	3.22	3.45	3.68	4.13	4.58	4.80	5.03	5.47	6.34	6.77
	3500	2.31	2.53	2.76	3.22	3.44	3.67	4.12	4.56	4.78	5.00	5.43	6.29	6.71
	5000	2.30	2.52	2.75	3.19	3.41	3.63	4.06	4.48	4.69	4.90	5.31	6.09	6.46
	8000	2.27	2.48	2.70	3.11	3.32	3.52	3.90	4.26	4.43	4.60	4.92	5.47	5.70
	10000	2.24	2.45	2.65	3.04	3.23	3.41	3.75	4.05	4.19	4.32	4.56	4.89	4.99
<b>Belt Width (in)</b>		<b>1/4</b>	<b>5/16</b>	<b>3/8</b>	<b>7/16</b>	<b>1/2</b>								
Width Multiplier		1.00	1.29	1.59	1.89	2.20								

## Twin Power Belt Drive Systems

Twin Power Belts are similar in construction to standard synchronous belts, including nylon-faced teeth on both sides. This construction uses essentially the same design parameters as standard synchronous belts. Gates XL Twin Power Timing belts have helically-wound fiberglass tension members embedded in a Neoprene body with the belt teeth faced with a tough wear-resistant nylon fabric. A unique feature of this construction is that Gates Twin Power belts can transmit their full rated load on either the front or back side.

The three principal dimensions, in inches, shown below, are used to specify a Twin Power Timing belt.

TP	330	XL	025
Twin	33.0"	0.200"	0.25"
Power	Pitch Length	Pitch	Wide

Belt pitch is the distance in inches between two adjacent tooth centers as measured on the pitch line of the belt. Belt pitch length is the total length (circumference) in inches as measured along the pitch line. The theoretical pitch line of a Timing belt lies within the tensile member.

**NOTE:** For drive design procedure, see page 24.

**XL Pitch – Reference Dimensions**

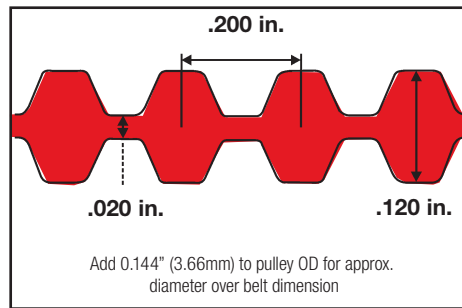



# PowerGrip® Timing Belt Drives – Twin Power

## PowerGrip Belt Lengths and Widths

### XL Timing Belt Length

Description	Pitch Length (in)	No. of Teeth	Description	Pitch Length (in)	No. of Teeth	Description	Pitch Length (in)	No. of Teeth	Description	Pitch Length (in)	No. of Teeth
•TP124XL	12.40	62	•TP182XL	18.20	91	•TP260XL	26.00	130	•TP400XL	40.00	200
•TP126XL	12.60	63	•TP184XL	18.40	92	•TP262XL	26.20	131	•TP412XL	41.20	206
•TP128XL	12.80	64	•TP186XL	18.60	93	•TP264XL	26.40	132	•TP420XL	42.00	210
•TP130XL	13.00	65	•TP188XL	18.80	94	•TP266XL	26.60	133	•TP424XL	42.40	212
•TP132XL	13.20	66	•TP190XL	19.00	95	•TP268XL	26.80	134	•TP432XL	43.20	216
•TP134XL	13.40	67	•TP192X	19.20	96	•TP270XL	27.00	135	•TP438XL	43.80	219
•TP136XL	13.60	68	•TP194XL	19.40	97	•TP274XL	27.40	137	•TP444XL	44.40	222
•TP138XL	13.80	69	•TP200XL	20.00	100	•TP280XL	28.00	140	•TP450XL	45.00	225
•TP140XL	14.00	70	•TP202XL	20.20	101	•TP286XL	28.60	143	•TP454XL	45.40	227
•TP142XL	14.20	71	•TP204XL	20.40	102	•TP290XL	29.00	145	•TP460XL	46.00	230
•TP144XL	14.40	72	•TP206XL	20.60	103	•TP296XL	29.60	148	•TP468XL	46.80	234
•TP146XL	14.60	73	•TP210XL	21.00	105	•TP300XL	30.00	150	•TP480XL	48.00	240
•TP148XL	14.80	74	•TP212XL	21.20	106	•TP306XL	30.60	153	•TP492XL	49.20	246
•TP150XL	15.00	75	•TP214XL	21.40	107	•TP310XL	31.00	155	•TP498XL	49.80	249
•TP152XL	15.20	76	•TP218XL	21.80	109	•TP316XL	31.60	158	•TP500XL	50.00	250
•TP154XL	15.40	77	•TP220XL	22.00	110	•TP320XL	32.00	160	•TP506XL	50.60	253
•TP156XL	15.60	78	•TP222XL	22.20	111	•TP322XL	32.20	161	•TP524XL	52.40	262
•TP158XL	15.80	79	•TP226XL	22.60	113	•TP330XL	33.00	165	•TP570XL	57.00	285
•TP160XL	16.00	80	•TP228XL	22.80	114	•TP338XL	33.80	169	•TP580XL	58.00	290
•TP162XL	16.20	81	•TP230XL	23.00	115	•TP340XL	34.00	170	•TP592XL	59.20	296
•TP164XL	16.40	82	•TP232XL	23.20	116	•TP344XL	34.40	172	•TP612XL	61.20	306
•TP166XL	16.60	83	•TP234XL	23.40	117	•TP348XL	34.80	174	•TP630XL	63.00	315
•TP168XL	16.80	84	•TP236XL	23.60	118	•TP350XL	35.00	175	•TP672XL	67.20	336
•TP170XL	17.00	85	•TP240XL	24.00	120	•TP352XL	35.20	176	•TP690XL	69.00	345
•TP172XL	17.20	86	•TP244XL	24.40	122	•TP362XL	36.20	181	•TP770XL	77.00	385
•TP174XL	17.40	87	•TP246XL	24.60	123	•TP370XL	37.00	185	•TP850XL	85.00	425
•TP176XL	17.60	88	•TP250XL	25.00	125	•TP380XL	38.00	190			
•TP178XL	17.80	89	•TP254XL	25.40	127	•TP384XL	38.40	192			
•TP180XL	18.00	90	•TP258XL	25.80	129	•TP390XL	39.00	195			

Stock lengths are denoted by a •. All other sizes, contact Gates Customer Service for availability.

### XL Stock Belt Widths

Belt Width Code	Width (in)
025	1/4 (0.250)
037	3/8 (0.375)

# PowerGrip® Timing Belt Drives

## Pulley Specification Tables – MXL and XL Pulleys

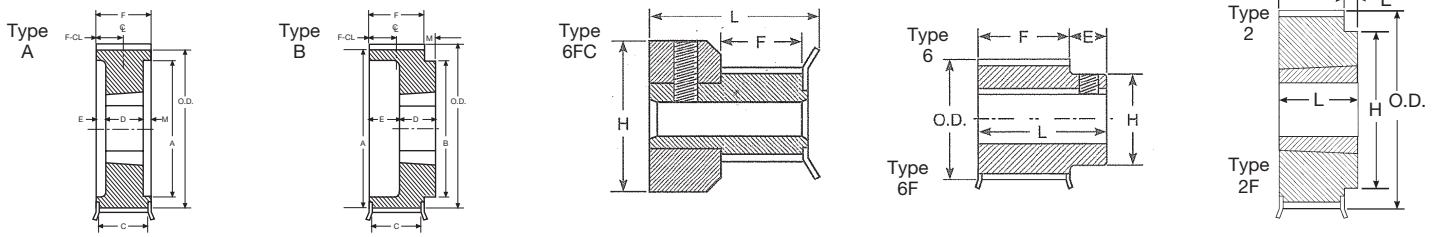

### 1/8 in Wide Belts (MXL012)

Sprocket Number	No. of Grooves	Diameter (in)			Design Type	Dimensions (in)						Set Screws**	Wt. (lb)	Material***
		Pitch	OD	Flange Ref.		W	L	H	E	Plain Bore* (in)				
										Min	Max			
10MXL012	10	0.255	0.235	0.425	6FC	0.160	0.438	0.425	0.234	0.125	0.125	4-40	0.01	AL
11MXL012	11	0.280	0.260	0.450	6FC	0.160	0.438	0.450	0.234	0.125	0.125	4-40	0.01	AL
12MXL012	12	0.306	0.286	0.480	6FC	0.160	0.438	0.480	0.234	0.125	0.125	4-40	0.01	AL
14MXL012	14	0.357	0.337	0.530	6FC	0.160	0.438	0.530	0.234	0.125	0.188	4-40	0.01	AL
15MXL012	15	0.382	0.362	0.555	6FC	0.160	0.438	0.555	0.234	0.188	0.188	4-40	0.01	AL
16MXL012	16	0.407	0.387	0.580	6FC	0.160	0.438	0.580	0.234	0.188	0.250	4-40	0.01	AL
18MXL012	18	0.458	0.438	0.635	6F	0.160	0.484	0.312	0.224	0.188	0.188	4-40	0.01	AL
20MXL012	20	0.509	0.489	0.685	6F	0.160	0.484	0.364	0.224	0.188	0.188	4-40	0.01	AL
21MXL012	21	0.535	0.515	0.710	6F	0.160	0.484	0.390	0.224	0.188	0.188	4-40	0.01	AL
22MXL012	22	0.560	0.540	0.740	6F	0.160	0.484	0.390	0.224	0.188	0.188	4-40	0.01	AL
24MXL012	24	0.611	0.591	0.790	6F	0.160	0.516	0.442	0.256	0.250	0.250	6-40	0.01	AL
28MXL012	28	0.713	0.693	0.895	6F	0.160	0.516	0.494	0.256	0.250	0.250	6-40	0.01	AL
30MXL012	30	0.764	0.744	0.945	6F	0.160	0.516	0.546	0.256	0.250	0.313	6-40	0.02	AL
32MXL012	32	0.815	0.795	1.000	6F	0.160	0.516	0.598	0.256	0.250	0.375	6-40	0.02	AL
36MXL012	36	0.917	0.897	1.105	6F	0.160	0.516	0.676	0.256	0.250	0.375	6-40	0.02	AL
40MXL012	40	1.019	0.999	1.210	6F	0.160	0.531	0.754	0.255	0.250	0.500	6-40	0.03	AL
42MXL012	42	1.070	1.050	1.260	6F	0.160	0.531	0.806	0.255	0.250	0.500	6-40	0.04	AL
44MXL012	44	1.120	1.100	1.315	6F	0.160	0.531	0.858	0.255	0.250	0.625	6-40	0.04	AL
48MXL012	48	1.222	1.202	1.420	6F	0.160	0.531	0.936	0.255	0.250	0.625	6-40	0.05	AL
60MXL012	60	1.528	1.508	1.730	6F	0.160	0.531	1.222	0.255	0.250	0.750	6-40	0.08	AL

### 1/4 in Wide Belts (MXL025)

Sprocket Number	No. of Grooves	Diameter (in)			Design Type	Dimensions (in)						Set Screws**	Wt. (lb)	Material***
		Pitch	OD	Flange Ref.		W	L	H	E	Plain Bore* (in)				
										Min	Max			
10MXL025	10	0.255	0.235	0.425	6FC	0.290	0.563	0.425	0.234	0.125	0.125	4-40	0.01	AL
11MXL025	11	0.280	0.260	0.450	6FC	0.290	0.563	0.450	0.234	0.125	0.125	4-40	0.01	AL
12MXL025	12	0.306	0.286	0.480	6FC	0.290	0.563	0.480	0.234	0.125	0.125	4-40	0.01	AL
14MXL025	14	0.357	0.337	0.530	6FC	0.290	0.563	0.530	0.234	0.125	0.188	4-40	0.01	AL
15MXL025	15	0.382	0.362	0.555	6FC	0.290	0.563	0.555	0.234	0.188	0.188	6-40	0.01	AL
16MXL025	16	0.407	0.387	0.580	6FC	0.290	0.563	0.580	0.234	0.188	0.250	6-40	0.01	AL
18MXL025	18	0.458	0.438	0.635	6F	0.290	0.625	0.312	0.234	0.188	0.188	6-40	0.01	AL
20MXL025	20	0.509	0.489	0.685	6F	0.290	0.625	0.364	0.234	0.188	0.188	6-40	0.01	AL
21MXL025	21	0.535	0.515	0.710	6F	0.290	0.625	0.390	0.234	0.188	0.188	6-40	0.01	AL
22MXL025	22	0.560	0.540	0.740	6F	0.290	0.625	0.390	0.234	0.188	0.188	6-40	0.01	AL
24MXL025	24	0.611	0.591	0.790	6F	0.290	0.688	0.442	0.299	0.250	0.250	6-40	0.01	AL
25MXL025	25	0.637	0.617	0.815	6F	0.290	0.688	0.468	0.299	0.250	0.250	6-40	0.01	AL
28MXL025	28	0.713	0.693	0.895	6F	0.290	0.688	0.494	0.299	0.250	0.250	6-40	0.02	AL
30MXL025	30	0.764	0.744	0.945	6F	0.290	0.688	0.546	0.299	0.250	0.313	8-32	0.02	AL
32MXL025	32	0.815	0.795	1.000	6F	0.290	0.688	0.598	0.299	0.250	0.375	8-32	0.03	AL
36MXL025	36	0.917	0.897	1.105	6F	0.290	0.688	0.676	0.299	0.250	0.375	8-32	0.03	AL
40MXL025	40	1.019	0.999	1.210	6F	0.290	0.719	0.754	0.314	0.250	0.500	8-32	0.04	AL
42MXL025	42	1.070	1.050	1.260	6F	0.290	0.719	0.806	0.314	0.250	0.500	8-32	0.05	AL
44MXL025	44	1.120	1.100	1.315	6F	0.290	0.719	0.858	0.314	0.250	0.625	8-32	0.05	AL
48MXL025	48	1.222	1.202	1.420	6F	0.290	0.719	0.936	0.314	0.250	0.625	8-32	0.08	AL
60MXL025	60	1.528	1.508	1.730	6F	0.290	0.719	1.222	0.314	0.250	0.750	8-32	0.11	AL
72MXL025	72	1.833	1.813	---	6	0.375	0.750	1.195	0.375	0.250	0.750	8-32	0.13	AL
80MXL025	80	2.037	2.017	---	6	0.375	0.750	1.500	0.375	0.313	0.750	8-32	0.18	AL
90MXL025	90	2.292	2.272	---	6	0.375	0.750	1.500	0.375	0.313	0.750	8-32	0.21	AL
100MXL025	100	2.546	2.526	---	6	0.375	0.750	1.500	0.375	0.313	0.750	8-32	0.24	AL
120MXL025	120	3.056	3.036	---	6	0.375	0.750	1.500	0.375	0.375	0.750	10-32	0.32	AL

\*Plain bore style stocked in smallest bore. \*\*10-16 groove pulleys have 1 ea. set screw, all others have 2 ea. set screws at 90 degrees. \*\*\*Gold Iridite Finish

NOTE: See Synchronous Belt Drives — Sprocket Specifications section, Page 76, for a complete table of stock and non-stock pulley diameters.

For non-standard designs contact Gates Made-To-Order Metals Team at (800)709-6001



# PowerGrip® Timing Belt Drives

## Pulley Specification Tables – MXL and XL Pulleys - Continued

### 1/4 in Wide Belts (XL025)

Sprocket Number	No. of Grooves	Diameter (in)			Design Type	Dimensions (in)						Set Screws**	Wt. (lb)	Material***
		Pitch	OD	Flange Ref.		W	L	H	E	Plain Bore* (in)				
										Min	Max			
10XL025	10	0.637	0.617	0.875	6F	0.310	0.688	0.375	0.250	0.188	0.250	6-40	0.01	AL
11XL025	11	0.700	0.680	0.938	6F	0.310	0.688	0.438	0.250	0.188	0.250	6-40	0.02	AL
12XL025	12	0.764	0.744	1.000	6F	0.310	0.688	0.500	0.250	0.188	0.313	6-40	0.02	AL
13XL025	13	0.828	0.808	1.063	6F	0.310	0.688	0.563	0.250	0.250	0.313	8-32	0.03	AL
14XL025	14	0.891	0.871	1.032	6F	0.310	0.688	0.563	0.250	0.250	0.375	8-32	0.03	AL
15XL025	15	0.955	0.935	1.188	6F	0.310	0.688	0.625	0.250	0.250	0.500	8-32	0.03	AL
16XL025	16	1.019	0.999	1.250	6F	0.310	0.688	0.688	0.250	0.313	0.500	8-32	0.04	AL
18XL025	18	1.146	1.126	1.375	6F	0.310	0.688	0.813	0.250	0.250	0.500	8-32	0.05	AL
20XL025	20	1.273	1.253	1.500	6F	0.310	0.750	0.938	0.312	0.250	0.500	8-32	0.07	AL
21XL025	21	1.337	1.317	1.563	6F	0.310	0.750	1.000	0.312	0.250	0.500	8-32	0.08	AL
22XL025	22	1.401	1.381	1.625	6F	0.310	0.750	1.000	0.312	0.250	0.625	8-32	0.09	AL
24XL025	24	1.528	1.508	1.750	6F	0.310	0.781	1.063	0.343	0.250	0.625	8-32	0.10	AL
26XL025	26	1.655	1.635	1.875	6F	0.310	0.781	1.188	0.343	0.250	0.625	8-32	0.12	AL
28XL025	28	1.783	1.763	2.000	6F	0.310	0.781	1.188	0.343	0.250	0.750	8-32	0.14	AL
30XL025	30	1.910	1.890	2.125	6F	0.310	0.781	1.313	0.343	0.250	0.750	8-32	0.16	AL

## XL [0.200 in] PowerGrip Timing Pulleys

### 3/8 in Wide Belts (XL037)

Sprocket Number	No. of Grooves	Diameter (in)			Design Type	Dimensions (in)										Bushing Size	Bore Sizes* (in)		Set Screws**	Approx. Wt. (lb)	Material***
		Pitch	OD	Flange Ref.		A	B	C	D	E	F	M	F-CL	Min	Max						
																	Min	Max			
10XL037	10	0.637	0.617	0.875	6F	---	0.438	0.430	0.813	0.383	0.563	0	0.664	MPB	0.188	0.188	6-40	0.05	ST		
11XL037	11	0.700	0.680	0.938	6F	---	0.500	0.430	0.813	0.383	0.563	0	0.664	MPB	0.188	0.188	6-40	0.07	ST		
12XL037	12	0.764	0.744	1.000	6F	---	0.500	0.430	0.813	0.383	0.563	0	0.664	MPB	0.188	0.313	6-40	0.08	ST		
13XL037	13	0.828	0.808	1.063	6F	---	0.563	0.430	0.813	0.383	0.563	0	0.664	MPB	0.250	0.313	8-32	0.03	AL		
14XL037	14	0.891	0.871	1.094	6F	---	0.563	0.430	0.813	0.383	0.563	0	0.664	MPB	0.250	0.375	8-32	0.10	ST		
15XL037	15	0.955	0.935	1.188	6F	---	0.625	0.430	0.813	0.383	0.563	0	0.664	MPB	0.250	0.500	8-32	0.12	ST		
16XL037	16	1.019	0.999	1.250	6F	---	0.688	0.430	0.813	0.383	0.563	0	0.664	MPB	0.250	0.500	8-32	0.15	ST		
17XL037	17	1.082	1.062	1.313	6F	---	0.750	0.430	0.813	0.383	0.563	0	0.664	MPB	0.250	0.500	8-32	0.06	AL		
18XL037	18	1.146	1.126	1.375	6F	---	0.813	0.430	0.813	0.383	0.563	0	0.664	MPB	0.250	0.500	8-32	0.18	ST		
19XL037	19	1.210	1.190	1.438	6F	---	0.875	0.430	0.813	0.383	0.563	0	0.664	MPB	0.250	0.500	8-32	0.07	AL		
20XL037	20	1.273	1.253	1.500	6F	---	0.938	0.430	0.875	0.445	0.563	0	0.727	MPB	0.250	0.625	8-32	0.24	ST		
21XL037	21	1.337	1.317	1.563	6F	---	1.000	0.430	0.875	0.445	0.563	0	0.727	MPB	0.250	0.625	8-32	0.27	ST		
22XL037	22	1.401	1.381	1.625	6F	---	1.000	0.430	0.875	0.445	0.563	0	0.727	MPB	0.250	0.625	8-32	0.29	ST		
23XL037	23	1.464	1.444	1.688	6F	---	1.063	0.430	0.875	0.445	0.563	0	0.727	MPB	0.250	0.625	8-32	0.11	AL		
24XL037	24	1.528	1.508	1.750	6F	---	1.063	0.430	0.906	0.476	0.563	0	0.758	MPB	0.250	0.625	8-32	0.35	ST		
25XL037	25	1.592	1.572	1.813	6F	---	1.094	0.430	0.906	0.476	0.563	0	0.758	MPB	0.250	0.625	8-32	0.13	AL		
26XL037	26	1.655	1.635	1.875	6F	---	1.188	0.430	0.906	0.476	0.563	0	0.758	MPB	0.250	0.750	8-32	0.16	AL		
28XL037	28	1.783	1.763	2.000	6F	---	1.188	0.430	0.906	0.476	0.563	0	0.758	MPB	0.250	0.750	8-32	0.47	ST		
30XL037	30	1.910	1.890	2.125	6F	---	1.313	0.430	0.906	0.476	0.563	0	0.758	MPB	0.313	0.750	8-32	0.54	ST		
32XL037	32	2.037	2.017	2.250	6F	---	1.438	0.430	0.906	0.476	0.563	0	0.758	MPB	0.250	0.750	8-32	0.22	AL		
32XL037	32	2.037	2.017	---	A	---	---	---	0.78	0	0.563	0	0.282	1108	0.500	1.000	---	0.25	S		
36XL037	36	2.292	2.272	---	6	---	1.500	---	1.000	0.375	0.563	0	0.657	MPB	0.313	1.000	8-32	0.28	AL		
36XL037	36	2.292	2.272	---	A	---	---	---	0.78	0	0.563	0	0.282	1108	0.500	1.000	---	0.38	S		
40XL037	40	2.546	2.526	---	6	---	1.500	---	1.000	0.375	0.563	0	0.657	MPB	0.313	1.000	8-32	0.33	AL		
40XL037	40	2.546	2.526	---	B	---	2.156	---	0.78	0	0.563	0.22	0.500	1108	0.500	1.000	---	0.57	S		
42XL037	42	2.674	2.654	---	6	---	1.500	---	1.000	0.375	0.563	0	0.657	MPB	0.313	1.000	8-32	0.36	AL		
42XL037	42	2.674	2.654	---	B	---	2.266	---	0.78	0	0.563	0.22	0.500	1108	0.500	1.000	---	0.67	S		
44XL037	44	2.801	2.781	---	6	---	1.500	---	1.000	0.375	0.563	0	0.657	MPB	0.313	1.000	8-32	0.39	AL		
44XL037	44	2.801	2.781	---	B	---	2.344	---	0.78	0	0.563	0.22	0.500	1108	0.500	1.000	---	0.77	S		
45XL037	45	2.865	2.845	---	6	---	1.500	---	1.000	0.375	0.563	0	0.657	MPB	0.313	1.000	8-32	0.32	AL		
48XL037	48	3.056	3.036	---	6	---	1.500	---	1.000	0.375	0.563	0	0.657	MPB	0.313	1.000	8-32	0.39	AL		
48XL037	48	3.056	3.036	---	B	---	2.594	---	0.78	0	0.563	0.22	0.500	1108	0.500	1.000	---	0.99	S		
50XL037	50	3.183	3.163	---	6	---	1.500	---	1.000	0.375	0.563	0	0.657	MPB	0.313	1.000	8-32	0.42	AL		
60XL037	60	3.820	3.800	---	6	---	1.500	---	1.000	0.375	0.563	0	0.657	MPB	0.375	1.000	10-32	0.50	AL		
60XL037	60	3.820	3.800	---	B	---	3.406	---	0.98	0	0.563	0.44	0.719	1210	0.500	1.250	---	2.02	S		
72XL037	72	4.584	4.564	---	6	---	1.500	---	1.000	0.375	0.563	0	0.657	MPB	0.375	1.000	10-32	0.67	AL		
72XL037	72	4.584	4.564	---	B	---	4.000	---	0.98	0	0.563	0.44	0.719	1610	0.500	1.688	---	2.86	S		

\*Plain bore style stocked in smallest bore. \*\*All pulleys have 2 set screws at 90 degrees \*\*\*AL Pulleys Have Clear Anodized Finish  
**NOTE:** See Synchronous Belt Drives — Sprocket Specifications section, Page 76, for a complete table of stock and non-stock pulley diameters.  
 For non-standard designs contact Gates Made-To-Order Metals Team at (800)709-6001

# PowerGrip® Long-Length Belting

Long-Length belting is produced in Spiral form. Spiral cut belting is produced from a belt sleeve by moving the slitter laterally while the belt sleeve is rotating.

The resulting belting does not have continuous tensile cords, and the teeth are not perfectly perpendicular to the longitudinal axis of the belt. As long as the belt width is narrow, these properties have been found to contribute little if any detrimental effects to belt performance. Tensile modulus and strength are equivalent to conventional endless and long length belting.

This innovative product is available in all types of PowerGrip belting in all pitches. Reciprocating carriage drives requiring the use of higher performance curvilinear tooth belt products in long length form can now be easily handled. Contact Gates Product Application Engineering for specific application details and assistance in design.

## Long Length Belting Specifications

### Long-Length Belting Designations

PowerGrip Long-Length Belting is specified using the same width and pitch codes as standard PowerGrip belts, except that it includes an LL prefix and omits the length code. Thus a 250 ft. length of XL (.200 in) pitch belting in a 3/8 in. width carries the specification 250 ft. LL037XL.

### Drive Selection With PowerGrip Long-Length Belting

Drive selection procedures for drives using Long-Length Belting are much the same as for drives using conventional endless belting. Refer to the appropriate product and engineering sections in this catalog for drive torque ratings, engineering information, sprocket details, belt tension recommendations, etc. Table 6 includes rated

belt working tension data, minimum belt tensile strength, and belt tensile modulus values for those applications for which it could be helpful, as well as minimum order quantities.

For drive design selection assistance with PowerGrip Long-Length Belting, contact Gates Product Application Engineering.

**Table 6 – PowerGrip Long-Length Belting Specifications**

Pitch	Width	Code	Rated Working Tension (Ta) (lb)							Fiberglass Cord		Minimum Order Quantity (ft)	Maximum Cont. Length (ft)
			Number of Pulley Grooves							Minimum Breaking Strength (lb)	Tension (lb) For 0.1% Elongation		
			12	14	16	18	20	30	45				
MXL (0.080 in)	1/4 in.	LL025MXL	5.3	5.3	5.3	5.3	5.3	5.3	5.3	120	5.2	50	475
	3/8 in.	LL037MXL	8.0	8.0	8.0	8.0	8.0	8.0	8.0	180	7.8	50	300
	1/2 in.	LL050MXL	11	11	11	11	11	11	11	270	10.4	50	240
XL (0.200 in)	1/4 in.	LL025XL	7.3	7.3	7.3	7.3	7.3	7.3	7.3	250	6.1	50	460
	3/8 in.	LL037XL	12	12	12	12	12	12	12	375	9.1	50	300
	1/2 in.	LL050XL	16	16	16	16	16	16	16	555	12.2	50	225
3M HTD (3mm)	6mm	LL3M06	18	18	19	19	20	22	25	230	7.0	50	300
	9mm	LL3M09	29	30	31	32	33	36	42	345	10.5	50	300
	15mm	LL3M15	53	54	55	57	58	65	74	640	19.5	50	185
5M HTD (5mm)	9mm	LL5M09	--	43	44	46	47	53	61	710	27.4	50	300
	15mm	LL5M15	--	82	84	86	88	99	116	1315	50.8	50	185
	25mm	LL5M25	--	146	150	154	158	178	207	2190	84.6	50	100
2MGT GT3 (2mm)	4mm	LL2MGT04	23	23	23	24	24	24	23	85	2.6	50	300
	6mm	LL2MGT06	38	39	39	39	39	39	39	125	3.8	50	300
	9mm	LL2MGT09	62	63	64	64	65	65	63	190	5.7	50	300
3MGT GT3 (3mm)	6mm	LL3MGT06	--	--	46	48	49	53	54	230	6.0	50	600
	9mm	LL3MGT09	--	--	76	79	81	87	89	345	8.9	50	385
	15mm	LL3MGT15	--	--	141	146	150	160	165	640	16.5	50	240
5MGT GT3 (5mm)	9mm	LL5MGT09	--	--	--	74	81	101	113	710	27.4	50	360
	15mm	LL5MGT15	--	--	--	138	151	188	210	1315	50.8	50	230

**NOTE:** The width tolerance on all long length spiral cut belting is +0.031 in. (0.8mm) –0.047 in. (1.2mm).

For non-standard belt widths, contact Gates Customer Service for minimum order quantity.



## I. Operating Characteristics

**NOTE:** This engineering section provides general engineering information for synchronous belts and sprockets (or pulleys) which are useful in general drive design work. Where we refer to “sprockets” (for PowerGrip® GT®3 and HTD belts), you can substitute “pulleys” for PowerGrip Timing Belts. If you need additional information, contact Gates Product Application Engineering, Denver.

### A. Low Speed Operation

Synchronous drives are especially well suited for low speed-high torque applications. Their positive driving nature prevents potential slippage associated with V-belt drives, and even allows significantly greater torque carrying capability. Small pitch synchronous drives operating at speeds of 50 ft./min. (.25 m/s) or less are considered to be low speed. Care should be taken in the drive selection process as stall and peak torques can sometimes be very high. While intermittent peak torques can often be carried by synchronous drives without special considerations, high cyclic peak torque loading should be carefully reviewed.

Proper belt installation tension and rigid drive bracketry and framework is essential in preventing belt tooth jumping under peak torque loads. It is also helpful to design with more than the normal minimum of 6 belt teeth in mesh to ensure adequate belt tooth shear strength.

Newer generation curvilinear systems like PowerGrip® GT®3 and PowerGrip HTD should be used in low speed-high torque applications, as PowerGrip Timing Belts are more prone to tooth jumping, and have significantly less load carrying capacity.

### B. High Speed Operation

Synchronous belt drives are often used in high speed applications even though V-belt drives are typically better suited. They are often used because of their positive driving characteristic (no creep or slip), and because they require minimal maintenance (minimal stretch). A significant drawback of high speed synchronous drives is drive noise. High speed synchronous drives will nearly always produce more noise than V-belt drives. Small pitch synchronous drives operating at speeds in excess of 1300 ft/min (6.6 m/s) are considered to be high speed.

Special considerations should be given to high speed drive designs, as a number of factors can significantly influence belt performance. Cord fatigue and belt tooth wear are the two most significant factors that must be controlled to ensure

success. Moderate sprocket diameters should be used to reduce the rate of cord flex fatigue. Designing with a smaller pitch belt will often provide better cord flex fatigue characteristics than a larger pitch belt. PowerGrip® GT®3 is especially well suited for high speed drives because of its excellent belt tooth entry/exit characteristics. Smooth interaction between the belt tooth and sprocket groove minimizes wear and noise. Belt installation tension is especially critical with high speed drives. Low belt tension allows the belt to ride out of the driveN sprocket resulting in rapid belt tooth and sprocket groove wear.

### C. Smooth Running

Some ultra-sensitive applications require the belt drive to operate with as little vibration as possible, as vibration sometimes has an effect on the system operation or finished manufactured product. In these cases, the characteristics and properties of all appropriate belt drive products should be reviewed. The final drive system selection should be based upon the most critical design requirements, and may require some compromise.

Vibration is not generally considered to be a problem with synchronous belt drives. Low levels of vibration typically result from the process of tooth meshing and/or as a result of their high tensile modulus properties. Vibration resulting from tooth meshing is a normal characteristic of synchronous belt drives, and cannot be completely eliminated. It can be minimized by avoiding small sprocket diameters, and instead choosing moderate sizes. The dimensional accuracy of the sprockets also influences tooth meshing quality. Additionally, the installation tension has an impact on meshing quality. PowerGrip® GT®3 drives mesh very cleanly, resulting in the smoothest possible operation. Vibration resulting from high tensile modulus can be a function of sprocket quality. Radial run out causes belt tension variation with each sprocket revolution. V-belt sheaves are also manufactured with some radial run out, but V-belts have a lower tensile modulus resulting in less belt tension variation. The high tensile modulus found in synchronous belts is necessary to maintain proper pitch under load.

### D. Drive Noise

Drive noise evaluation in any belt drive system should be approached with care. There are many potential sources of noise in a system including vibration from related components, bearings, and resonance and amplification through framework and panels.

Synchronous belt drives typically produce more noise than V-belt drives. Noise results from the process of belt tooth meshing and physical contact with the sprockets. The sound pressure level generally increases as operating speed and belt width increases, and as sprocket diameter decreases. Drives designed on moderate sprocket sizes without excessive capacity (over-designed) are generally the quietest. PowerGrip® GT®3 drives have been found to be significantly quieter than other systems due to their improved meshing characteristics. Polyurethane belts generally produce more noise than neoprene belts. Proper belt installation tension is also very important in minimizing drive noise. The belt should be tensioned at a level that allows it to run with as little meshing interference as possible. See section *III. Belt Tensioning* on page 65 for additional tensioning guidelines.

Drive alignment also has a significant effect on drive noise. Special attention should be given to minimizing angular misalignment (shaft parallelism). This assures that belt teeth are loaded uniformly and minimizes side tracking forces against the flanges. Parallel misalignment (sprocket offset) is not as critical of a concern so long as the belt is not trapped or pinched between opposite flanges. Refer to section *II. Drive Alignment* on page 64 for more discussion on misalignment. Sprocket materials and dimensional accuracy also influence drive noise. Some users have found that steel sprockets are the quietest followed closely by aluminum. Polycarbonates have been found to be noisier than metallic materials. Machined sprockets are generally quieter than molded sprockets. The reasons for this revolve around material density and resonance characteristics as well as dimensional accuracy.

### E. Static Conductivity

Small synchronous rubber or urethane belts can generate an electrical charge while operating on a drive. Factors such as humidity and operating speed influence the potential of the charge. If determined to be a problem, rubber belts can be produced in a conductive construction to dissipate the charge into the sprockets, and to ground. This prevents the accumulation of electrical charges that might be detrimental to material handling processes or sensitive electronics. It also greatly reduces the potential for arcing or sparking in flammable environments. Urethane belts cannot be produced in a conductive construction.



## I. Operating Characteristics – Continued

ARPM has outlined standards for static conductive belts in their bulletin IP-3-3. Unless otherwise specified, Gates does not manufacture the synchronous rubber belt products included in this catalog to any specific conductivity standard. A static conductive construction for rubber belts is available on a made-to-order basis. Unless otherwise specified, conductive belts will be built to yield a resistance of 300,000 ohms or less when new. A static conductive belt has sufficient conductivity to prevent measurable static voltage buildup, thus preventing a static discharge.

When a belt is used in a hazardous environment, additional protection must be employed to assure that there are no accidental static spark discharges. The portion of the belt that contacts the sprocket must be conductive to ensure that static charge is conducted into the drive hardware. Synchronous belts must have a static conductive tooth surface in contact with conductive sprocket grooves.

Unusual or excessive debris or contaminant on the belt contact surface or sprocket grooves should be cleaned and removed.

Any belt drive system that operates in a potentially hazardous environment must be properly grounded. A continuous conductive path to ground is necessary to bleed off the static charge. This path includes a static conductive belt, a conductive sprocket, a conductive bushing, a conductive shaft, conductive bearings, and the ground. As an additional measure of protection, a static-conductive brush or similar device should be employed to bleed off any residual static buildup that might remain around the belt.

Non-conductive belt constructions are also available for rubber belts. These belts are generally built specifically to the customer's conductivity requirements. They are generally used in applications where one shaft must be electrically isolated from the other.

It is important to note that a static conductive belt cannot dissipate an electrical charge through plastic sprockets. At least one metallic sprocket in a drive is required for the charge to be dissipated to ground. A grounding brush or similar device can also be used to dissipate electrical charges.

Urethane timing belts are not static conductive and cannot be built in a special conductive construction. Special conductive rubber belts should be used when the presence of an electrical charge is a concern.

### F. Operating Environments

Synchronous drives are suitable for use in a wide variety of environments. Special considerations may be necessary, however, depending on the application.

**Temperature:** Either excessively high or low environmental temperatures can present problems to synchronous belts. The maximum recommended environmental temperature for stock belts is 185 deg. F (85 deg. C). Environmental temperatures beyond this result in gradual compound hardening as the vulcanization process continues. The belt will eventually begin cracking as it stiffens. A high temperature construction capable of a continuous environmental temperature of 230 deg. F (110 deg. C) and intermittent peaks up to 250 deg. F (121 deg. C) is available on a made-to-order basis.

**Dust:** Dusty environments do not generally present serious problems to synchronous drives as long as the particulates are fine and dry. Particulate matter will, however, act as an abrasive resulting in a higher rate of belt and sprocket wear. Damp or sticky particulate matter deposited and packed into sprocket grooves can cause belt tension to increase significantly. This increased tension can impact shafting, bearings, and framework. Electrical charges within a drive system can sometimes attract particulate matter.

**Debris:** Debris should be prevented from falling into any synchronous belt drive. Debris caught in the drive is generally either forced through the belt or results in a stalling of the system. In either case, serious damage occurs to the belt and related drive hardware.

**Water:** Light and occasional contact with water (occasional wash downs) should not seriously affect synchronous belts. Prolonged contact (constant spray or submersion) results in significantly reduced tensile strength in fiberglass belts, and potential length variation in aramid belts. Prolonged contact with water also causes rubber compounds to swell, although less than with oil contact. Internal belt adhesion systems are also gradually broken down with the presence of water. Additives to water such as lubricants, chlorine, anti corrosives, etc. can have a more detrimental effect on the belts than pure water. Urethane timing belts also suffer from water contamination. Polyester tensile cord shrinks significantly and experiences loss of tensile strength in the presence of water. Aramid

tensile cord maintains its strength fairly well, but experiences length variation. Urethane swells more than neoprene in the presence of water. This swelling can increase belt tension significantly causing belt and related hardware problems.

**Oil:** Light contact with oils on an occasional basis will not generally damage synchronous belts. Prolonged contact with oil or lubricant, either directly or airborne, results in significantly reduced belt service. Lubricants cause the rubber compound to swell, break down internal adhesion systems, and reduce belt tensile strength. While alternate rubber compounds may provide some marginal improvement in durability, it is best to prevent oil from contacting synchronous belts.

**Ozone:** The presence of ozone can be detrimental to the compounds used in rubber synchronous belts. Ozone degrades belt materials in much the same way as excessive environmental temperatures. Although the rubber materials used in synchronous belts are compounded to resist the effects of ozone, eventually chemical break down occurs and they become hard and brittle and begin cracking. The amount of degradation depends upon the ozone concentration and time of exposure. For good performance of rubber belts, the following concentration levels should not be exceeded: (parts per hundred million)

Standard Construction: 100 pphm  
Non Marking Construction: 20 pphm  
Conductive Construction: 75 pphm  
Low Temperature Construction: 20 pphm

**Radiation:** Exposure to gamma radiation can be detrimental to the compounds used in rubber and urethane synchronous belts. Radiation degrades belt materials much the same way excessive environmental temperatures do. The amount of degradation depends upon the intensity of radiation and the exposure time. For good belt performance, the following exposure levels should not be exceeded:

Standard Construction: 10<sup>9</sup> rads  
Non Marking Construction: 10<sup>4</sup> rads  
Conductive Construction: 10<sup>6</sup> rads  
Low Temperature Construction: 10<sup>4</sup> rads

**Dust Generation:** Rubber synchronous belts are known to generate small quantities of fine dust as a natural result of their operation. The quantity of dust is typically higher for new belts, as they run in. The period of time for run in to occur depends upon the belt and sprocket size, loading,



## I. Operating Characteristics – Continued

and speed. Factors such as sprocket surface finish, operating speeds, installation tension, and alignment influence the quantity of dust generated.

**Clean Room:** Rubber synchronous belts may not be suitable for use in clean room environments where all potential contamination must be minimized or eliminated. Urethane timing belts typically generate significantly less debris than rubber timing belts. However, they are recommended only for light operating loads. Also, they cannot be produced in a static conductive construction to allow electrical charges to dissipate.

**Static Sensitive:** Applications are sometimes sensitive to the accumulation of static electrical charges. Electrical charges can affect material handling processes (like paper and plastic film transport), and sensitive electronic equipment. Applications like these require a static conductive belt so that the static charges generated by the belt can be dissipated into the sprockets, and to ground. Standard small pitch rubber synchronous belts do not meet this requirement, but can be manufactured in a static conductive construction on a made-to-order basis. Normal belt wear resulting from long term operation or environmental contamination can influence belt conductivity properties.

In sensitive applications, rubber synchronous belts are preferred over urethane belts since they cannot be produced in a conductive construction.

### G. Belt Tracking

Lateral tracking characteristics of synchronous belts is a common area of inquiry. While it is normal for a belt to favor one side of the sprockets while running, it is abnormal for a belt to exert significant force against a flange resulting in belt edge wear and potential flange failure. Belt tracking is influenced by several factors. In order of significance, discussion about these factors is as follows:

**Tensile Cord Twist:** Tensile cords are formed into a single twist configuration during their manufacture. Synchronous belts made with only single twist tensile cords track laterally with a significant force. To neutralize this tracking force, tensile cords are produced in right and left hand twist (or S and Z twist) configurations. Belts made with S twist tensile cords track in the opposite direction of those built with Z twist cord. Belts made with alternating S and Z twist tensile cords track with minimal lateral force because the tracking

characteristics of the two cords offset each other. The content of S and Z twist tensile cord varies slightly with every belt that is produced. As a result, every belt has an unpredictable tendency to track in either one direction or the other. When an application requires a belt to track in one specific direction only, a single-twist construction is used. Contact Gates Product Application Engineering for assistance in selecting the proper belt construction for special or unusual applications.

**Angular Misalignment:** Angular Misalignment, or shaft non parallelism, causes synchronous belts to track laterally. See section II. *Drive Alignment* on page 64 for more on misalignment. The angle of misalignment influences the magnitude and direction of the tracking force. Synchronous belts tend to track downhill to a state of lower tension or shorter center distance.

**Belt Width:** The potential magnitude of belt tracking force is directly related to belt width. Wide belts tend to track with more force than narrow belts.

**Sprocket Diameter:** Belts operating on small sprocket diameters can tend to generate higher tracking forces than on large diameters. This is particularly true as the belt width approaches the sprocket diameter. Drives with sprocket diameters less than the belt width are not generally recommended because belt tracking forces can become excessive.

**Belt Length:** Because of the way tensile cords are applied on to belt molds, short belts can tend to exhibit higher tracking forces than long belts. The helix angle of the tensile cord decreases with increasing belt length.

**Gravity:** In drive applications with vertical shafts, gravity pulls the belt downward. The magnitude of this force is minimal with small pitch synchronous belts. Sag in long belt spans should be avoided by applying adequate belt installation tension.

**Torque Loads:** Sometimes while in operation, a synchronous belt will move laterally from side to side on the sprockets rather than operating in a consistent position. While not generally considered to be a significant concern, one explanation for this is varying torque loads within the drive. Synchronous belts sometimes track differently with changing loads. There are many potential reasons

for this, the primary cause is related to tensile cord distortion while under pressure against the sprockets. Variation in belt tensile loads can also cause changes in framework deflection, and angular shaft alignment, resulting in belt movement.

**Belt Installation Tension:** Belt tracking is sometimes influenced by the level of belt installation tension. The reasons for this are similar to the effect that varying torque loads have on belt tracking.

When problems with belt tracking are experienced, each of these potential contributing factors should be investigated in the order that they are listed. In most cases, the primary problem will probably be identified before moving completely through the list.

### H. Sprocket Flanging

Sprocket guide flanges are necessary to keep synchronous belts operating on their sprockets. As discussed previously in section G on belt tracking, it is normal for synchronous belts to favor one side of the sprockets when running.

Proper flange design is important in preventing belt edge wear, minimizing noise and preventing the belt from climbing out of the sprocket. Dimensional recommendations for custom-made or molded flanges are included in Table 22 on Page 78.

Proper flange placement is important so that the belt is adequately restrained within its operating system. Because design and layout of small synchronous drives is so diverse, the wide variety of flanging situations potentially encountered cannot easily be covered in a simple set of rules without finding exceptions. Despite this, the following broad flanging guidelines should help the designer in most cases:

**Two Sprocket Drives:** On simple two sprocket drives, either one sprocket should be flanged on both sides, or each sprocket should be flanged on opposite sides.

**Multi Sprocket Drives:** On multiple sprocket (or serpentine) drives, either every other sprocket should be flanged on both sides, or every sprocket should be flanged on alternating sides around the system.

**Vertical Shaft Drives:** On vertical shaft drives, at least one sprocket should be flanged on both sides, and the remaining sprockets should be flanged on at least the bottom side.

## I. Operating Characteristics – Continued

**Long Span Lengths:** Flanging recommendations for small synchronous drives with long belt span lengths cannot easily be defined due to the many factors that can affect belt tracking characteristics. Belts on drives with long spans (generally 12 times the diameter of the smaller sprocket or more) often require more lateral restraint than with short spans. Because of this, it is generally a good idea to flange the sprockets on both sides.

**Large Sprockets:** Flanging large sprockets can be costly. Designers often wish to leave large sprockets unflanged to reduce cost and space. Belts generally tend to require less lateral restraint on large sprockets than small and can often perform reliably without flanges. When deciding whether or not to flange, the previous guidelines should be considered. The groove face width of unflanged sprockets should also be greater than with flanged sprockets. See Table 23 on Page 78 for specific recommendations.

**Idlers:** Flanging of idlers is generally not necessary. Idlers designed to carry lateral side loads from belt tracking forces can be flanged if needed to provide lateral belt restraint. Idlers used for this purpose can be used on the inside or backside of the belts. The previous guidelines should also be considered.

### I. Servo & Stepper Motors

Within automated machinery, motors are commonly used to provide rotational energy for specific positioning and placement operations. Motor output requirements in these applications differ from conventional motors in that shaft rotation must be incremental in accurate steps, capable of starting / stopping / reversing, variable speed, and may not ever run at a fixed speed for an extended period of time. In these position control systems, the motor shaft rotational position and speed, as well as output torque, must be accurately controlled.

A special class of motors are required to provide accurate motion and position control for automated systems. This class is primarily comprised of servo motors and stepper motors. These motors are used in a broad range of products in a variety of applications. They are used in low cost computer printers to accurately position the print heads, in ATMs and ticket dispensers to accurately increment rollers used in feeding and retrieving operations, in machine tools to accurately rotate precision lead screws and tool holders, etc.

Belt drives are sometimes used between precision motors and the final driven shafts for more compact motor placement, to multiply motor

output torque, or to reduce motor output speed.

### Belt Drive Design For Servo & Stepper

**Motors:** Establishing a design torque load from DC servo or step motor drives when designing a new belt drive system is not always a straight forward process. Every application is unique in the way that it utilizes the available motor output torque. Few applications run continuously, as most motion control systems are used for incremental positioning and placement. Many systems reciprocate back and forth, alternate speed and/or direction, operate intermittently, etc. By the nature of their operational diversity, DC servo and step motor drive systems may utilize maximum, stall, or holding motor torque at some periodic frequency.

While system duty cycle data is useful, the designer must still determine how to size a belt drive for the estimated system loads. While this determination is dependent upon many factors (design life, drive rigidity, equipment operation / usage, belt installation tension, etc.) and its basis may differ in every case, some rough guidelines from which to start may be useful.

In many DC servo or step motor drives, maximum, stall, or holding torque loads are considerably greater than continuous or intermittent loads. In addition, maximum, stall, and holding torque loads are seen on an intermittent basis. In these cases it is reasonable to size a belt drive for either the maximum, stall, or holding motor torque load rating (depending upon the system's operation) with a design service factor of 1.0. The capacity of the proposed belt drive should then be compared with normal system running loads (carried the majority of the time) to make sure that the selected belt drive will provide a design service factor within a typical range of 1.5 to 2.0.

Contact Gates Product Application Engineering for assistance in designing belt drive systems with servo and stepper motors.

### J. Registration

The three primary factors contributing to belt drive registration (or positioning) errors are belt elongation, backlash, and tooth deflection. When evaluating the potential registration capabilities of a synchronous belt drive, the system must first be determined to be either static or dynamic in terms of its registration function and requirements.

**Static Registration:** A static registration system moves from its initial static position to a secondary

static position. During the process the designer is concerned only with how accurately and consistently the drive arrives at its secondary position. Potential registration errors that occur during transport are not considered. Therefore, the primary factor contributing to registration error in a static registration system is backlash. The effects of belt elongation and tooth deflection do not have any influence on the registration accuracy of this type of system.

**Dynamic Registration:** A dynamic registration system is required to perform a registering function while in motion with torque loads varying as the system operates. In this case, the designer is concerned with the rotational position of the drive sprockets with respect to each other at every point in time. Therefore, belt elongation, backlash, and tooth deflection will all contribute to registration inaccuracies.

Further discussion about each of the factors contributing to registration error is as follows:

**Belt Elongation:** Belt elongation, or stretch, occurs naturally when a belt is placed under tension. The total tension exerted within a belt results from installation as well as working loads. The amount of belt elongation is a function of the belt tensile modulus, which is influenced by the type of tensile cord and the belt construction. The standard tensile cord used in rubber synchronous belts is fiberglass. Fiberglass has a high tensile modulus, is dimensionally stable, and has excellent flex-fatigue characteristics. If a higher tensile modulus is needed, aramid tensile cords can be considered, although they are generally used to provide resistance to harsh shock and impulse loads. Aramid tensile cords used in small synchronous belts generally have only a marginally higher tensile modulus in comparison to fiberglass. When needed, belt tensile modulus data is available from Gates Product Application Engineering.

**Backlash:** Backlash in a synchronous belt drive results from clearance between the belt teeth and the sprocket grooves. This clearance is needed to allow the belt teeth to enter and exit the grooves smoothly with a minimum of interference. The amount of clearance necessary depends upon the belt tooth profile. PowerGrip® Timing Belt Drives are known for having relatively little backlash. PowerGrip® HTD® Drives have improved torque carrying capability and resist ratcheting, but have a significant amount of backlash. PowerGrip® GT®3 Drives have even further improved torque

# Synchronous Belt Drives – Engineering

carrying capability, and have as little or less backlash than PowerGrip Timing Belt Drives. In special cases, alterations can be made to drive systems to further decrease backlash. These alterations typically result in increased belt wear, increased drive noise and shorter drive life. Contact Gates Product Application Engineering for additional information.

**Tooth Deflection:** Tooth deformation in a synchronous belt drive occurs as a torque load is applied to the system, and individual belt teeth are loaded. The amount of belt tooth deformation depends upon the amount of torque loading, sprocket size, installation tension and belt type. Of the three primary contributors to registration error, tooth deflection is the most difficult to quantify. Experimentation with a prototype drive system is the best means of obtaining realistic estimations of belt tooth deflection.

Additional guidelines that may be useful in designing registration critical drive systems are as follows:

- Select PowerGrip® GT<sup>3</sup> or PowerGrip Timing Drives.
- Design with large sprockets with more teeth in mesh.
- Keep belts tight, and control tension closely.
- Design frame/shafting to be rigid under load.
- Use high quality machined sprockets to minimize radial run out and lateral wobble.

## II. Drive Alignment

### A. Angular And Parallel

Drive misalignment is one of the most common sources of drive performance problems. Misaligned drives can exhibit symptoms such as high belt tracking forces, uneven belt tooth wear, high noise levels, and tensile cord failure. The two primary types of drive misalignment are angular and parallel. Discussion about each of these types are as follows:

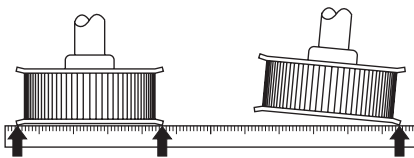

Figure 3 — Angular Misalignment

**Angular:** Angular misalignment results when the drive shafts are not parallel (see Fig. 3). As a result, the belt tensile cords are not loaded evenly, resulting in uneven tooth / land pressure and wear. The edge cords on the high tension side are often

overloaded. Overloading often results in an edge cord failure that propagates across the entire belt width. Angular misalignment often results in high belt tracking forces as well. High tracking forces cause accelerated belt edge wear, sometimes leading to flange failure or belts tracking off of the sprockets.

**Parallel:** Parallel misalignment results from sprockets being mounted out of line from each other (see Fig. 4). Parallel misalignment is generally more of a concern with V-type belts than with synchronous belts because V-type belts run in grooves and are unable to free float on the sheaves. Synchronous belts will generally free float on the sprockets and essentially self align themselves as they run. This self aligning can occur so long as the sprockets have sufficient groove face width beyond the width of the belts. If not, the belts can become trapped between opposite sprocket flanges causing serious performance problems. Parallel misalignment is not generally a significant concern with synchronous drives so long as the belts do not become trapped or pinched between opposite flanges. For recommendations on sprocket groove face width, see Table 23 on Page 78.

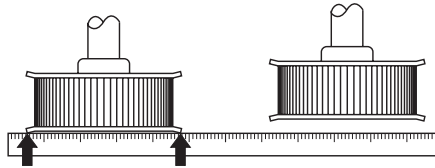

Figure 4 — Parallel Misalignment

**Allowable Misalignment:** In order to maximize performance and reliability, synchronous drives should be aligned closely. This is not, however, always a simple task in a production environment. The maximum allowable misalignment, angular and parallel combined, is 1/4".

### B. Practical Tips

Angular misalignment is not always easy to measure or quantify. It is sometimes helpful to use the observed tracking characteristics of a belt, to make a judgment as to the systems relative alignment. Neutral tracking S and Z synchronous belts generally tend to track "down hill" or to a state of lower tension or shorter center distance when angularly misaligned. This may not always hold true since neutral tracking belts naturally tend to ride lightly against either one flange or the other due to numerous factors discussed in section G., Belt Tracking on Page 62. This tendency will generally hold true with belts that track hard against a flange. In those cases, the shafts will require adjustment to

correct the problem.

Parallel misalignment is not often found to be a problem in synchronous belt drives. If clearance is always observable between the belt and all flanges on one side, then parallel misalignment should not be a concern.

## III. Belt Tensioning

### A. What Is Proper Installation Tension

One of the benefits of small synchronous belt drives is lower belt pre-tensioning in comparison to comparable V-belt drives, proper installation tension is still important in achieving the best possible drive performance. In general terms, belt pre-tensioning is needed for proper belt/sprocket meshing to prevent belt ratcheting under peak loading, to compensate for initial belt tension decay, and to pre-stress the drive framework. The amount of installation tension that is actually needed is influenced by the type of application as well as the system design. Some general examples of this are as follows:

**Motion Transfer Drives:** Motion transfer drives, by definition, are required to carry extremely light torque loads. In these applications, belt installation tension is needed only to cause the belt to conform to and mesh properly with the sprockets. The amount of tension necessary for this is referred to as the minimum tension ( $T_{st}$ ). Minimum tensions on a per span basis are included in Table 7 on page 65. Some motion transfer drives carry very little torque, but have tight registration requirements. These systems may require additional static (or installation) tension in order to minimize registration error.

**Normal Power Transmission Drives:** Normal power transmission drives should be designed in accordance with published torque ratings and a reasonable service factor (between 1.5 and 2.0). In these applications, belt installation tension is needed to allow the belt to maintain proper fit with the sprockets while under load, and to prevent belt ratcheting under peak loads. For these drives, proper installation tension can be determined using two different approaches. If torque loads are known and well defined, and an accurate tension value is desired, Formula 1, page 65 should be used. If the torque loads are not as well defined, and a quick value is desired for use as a starting point, values from Table 8 can be used. All static tension values are on a per span basis.

# Synchronous Belt Drives – Engineering

## III. Belt Tensioning – Continued

### Formula 1

$$T_{st} = \frac{1.21 Q}{d} + MS^2, \text{ lb.}$$

Where:  $T_{st}$  = Static Tension per span, pounds  
 $Q$  = driveR torque load, pound inches  
 $d$  = driveR pitch diameter, inches  
 $S$  = Belt Speed/1000, feet per minute  
 Belt Speed = (driveR pitch diameter x driveR rpm)/3820  
 $M$  = Mass factor from Table 7

**Table 7 - Tensioning Constants**

Belt Section	Belt Width	M	Y	Minimum $T_{st}$ (lb) Per Span
2MGT GT3	4mm	0.026	1.38	1.4
	6mm	0.039	2.08	2.1
	9mm	0.059	3.11	3.2
	12mm	0.078	4.15	4.2
3MGT GT3	6mm	0.078	3.23	2.4
	9mm	0.117	4.84	3.6
	12mm	0.156	6.46	4.8
	15mm	0.195	8.07	6.0
5MGT GT3	9mm	0.172	14.88	9.0
	12mm	0.229	19.84	12.0
	15mm	0.286	24.80	15.0
	25mm	0.476	41.33	25.0
3M HTD	6mm	0.067	3.81	3.0
	9mm	0.100	5.71	4.5
	15mm	0.167	9.52	7.5
5M HTD	9mm	0.163	14.88	8.1
	15mm	0.272	24.80	13.5
	25mm	0.453	41.33	22.5
MXL	1/8"	0.019	1.40	1.3
	3/16"	0.029	2.11	1.9
	1/4"	0.038	2.81	2.5
XL	1/4"	0.071	3.30	3.3
	3/8"	0.106	4.94	4.9

**Note:** If the value of  $T_{st}$  calculated with Formula 1 is less than the minimum  $T_{st}$  value in Table 7, use the Minimum  $T_{st}$  value from the table for  $T_{st}$  in all further belt tension calculations. The minimum value must be used on lightly loaded drives to ensure that belts wrap and mesh properly with the sprockets.

**Registration Drives:** Registration drives are required to register, or position, accurately (see section J. Registration on Page 63). Higher belt installation tensions help in increasing belt tensile modulus as well as in increasing meshing interference, both reducing backlash. Tension values for these applications should be determined experimentally to confirm that desired performance characteristics have been achieved. As a beginning point, use values from Table 8 multiplied by 1.5 to 2.0.

**Table 8 – Static Belt Tension – General Values  $T_{st}$  (lb) Per Span**

Section	PowerGrip® GT <sup>3</sup> Belt Widths						
	4 mm	6 mm	9 mm	12 mm	15 mm	20 mm	25 mm
2MGT GT3	6	10	17	24	-	-	-
3MGT GT3	-	14	24	33	43	61	-
5MGT GT3	-	-	27	38	50	70	91

**PowerGrip HTD Belt Widths**

3M	-	6	9	13	17	25	-
5M	-	-	10	-	19	26	34

**PowerGrip Timing Belt Widths**

Section	1/8"	3/16"	1/4"	5/16"	3/8"	7/16"	1/2"
MXL	2	3	4	4	5	-	-
XL	-	-	5	6	7	8	10

Most synchronous belt applications often exhibit their own individual operating characteristics. The static installation tensions recommended in this catalog should serve as a general guideline in determining the level of tension required. The drive system should be thoroughly tested to confirm that it performs as intended. Consult Gates Product Application Engineering for further guidance.

### B. Making Measurements

Belt installation tension is generally measured in the following ways:

**Force/Deflection:** Belt span tension can be measured by deflecting a belt span 1/64" per inch of span length at mid-span, with a known force (see Fig. 5). This method is generally convenient, but not always very accurate due to difficulty in measuring small deflections and forces common in small synchronous drives. The force/deflection method is most effective on larger drives with long span lengths. The static or installation tension ( $T_{st}$ ) can either be calculated from Formula 1 or selected from Table 7 or Table 8. The deflection forces can be calculated from Formula 3 and Formula 4. The span length can either be calculated from Formula 2 or measured. If the calculated static tension is less than the minimum  $T_{st}$  values in Table 7, use the minimum values.

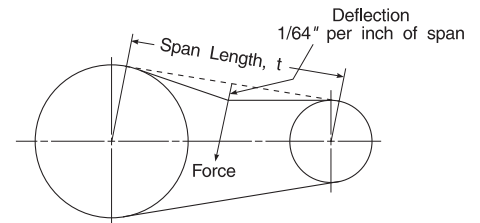

**Figure 5 - Belt Deflection Distance**

### Formula 2

$$t = \sqrt{CD^2 - \left(\frac{PD-pd}{2}\right)^2}$$

Where:  $t$  = span length, inches  
 $CD$  = Drive center distance  
 $PD$  = Large pitch diameter, inches  
 $pd$  = Small pitch diameter, inches

### Formula 3

$$\text{New deflection force, Min.} = \frac{T_{st} + \left(\frac{t}{L}\right)Y}{16}, \text{ lb.}$$

### Formula 4

$$\text{New deflection force, Max.} = \frac{1.1 T_{st} + \left(\frac{t}{L}\right)Y}{16}, \text{ lb.}$$

Where:  $T_{st}$  = Static tension, pounds  
 $t$  = span length, inches  
 $L$  = belt pitch length, inches  
 $Y$  = constant from Table 7

**Used Belt Note:** For re-installation of a used belt, a recommended tension of 0.7  $T_{st}$  to 0.8  $T_{st}$  value should be used in calculating the deflection forces, instead of the 1.0  $T_{st}$  to 1.1  $T_{st}$  shown for new belts.



## III. Belt Tensioning – Continued

**Shaft Separation:** Belt installation tension can be applied directly by exerting a force against either the driveR or driveN shaft in a simple 2 point drive system (see Fig. 6). The resulting belt tension will be accurate as the force applied to the driveR or driveN shaft. This method is considerably easier to perform than the force/deflection method, and in some cases more accurate.

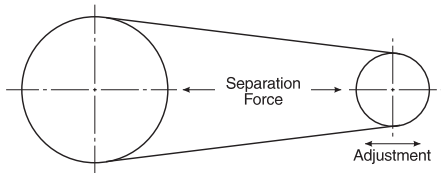

**Figure 6 - Shaft Separation**

In order to calculate the required shaft separation force, the proper static tension (on a per span basis) should first be determined as previously discussed. This tension value will be present in both belt spans as tension is applied. The angle of the spans with respect to the movable shaft should then be determined. The belt spans should be considered to be vectors (force with direction), and be summed into a single tension vector force (see Fig. 7). Refer to section VI. *Belt Pull* on pages 69 and 70 for further instructions on summing vectors. Contact Gates Product Application Engineering for assistance if needed.

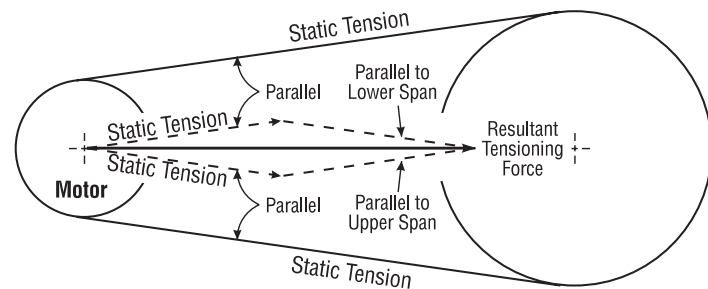

**Figure 7 - Vector Addition**

**Idler Force:** Belt installation tension can also be applied by exerting a force against an idler sprocket within the system that is used to take up belt slack (see Fig. 8). This force can be applied manually, or with a spring. Either way, the idler should be locked down after the appropriate tension has been applied.

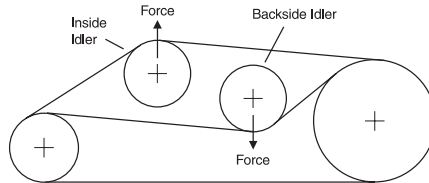

**Figure 8 - Idler Force**

Calculating the required force will involve a vector analysis as described above in the shaft separation section. Contact Gates Product Application Engineering for assistance if needed.

**Sonic Tension Meter:** The Sonic Tension Meter is an electronic device that measures the natural frequency of a free stationary belt span and instantly computes the static belt tension based upon the belt span length, belt width, and belt type. This provides accurate and repeatable tension measurements while using a non-intrusive procedure (the measurement process itself doesn't change the belt span tension). A measurement is made simply by plucking the belt while holding the sensor close to the vibrating belt span.

The unit is a bit larger than a cell phone (6" long x 2" wide x 1" thick) so it can be easily handled. The sensor is about 1/2" in diameter for use in cramped spaces, and the unit is battery operated. The unit measures virtually all types of Light Power & Precision belts.

For additional details, see Gates Publication No. 17898: *Sonic Tension Meter Uses Sound Waves to Measure Belt Tension Accurately Every Time.*

Contact Gates Product Application Engineering for further technical details. Contact Gates Customer Service for price and availability.



## IV. Installation and Take Up

### A. Installation Allowance

When designing a drive system for a production product, allowance for belt installation must be built into the system. While specific installation allowances could be published, as they are for larger industrial belt drives, small synchronous drive applications are generally quite diverse making it nearly impossible to arrive at values that apply in all cases. When space is at a premium, the necessary installation allowances should be determined experimentally using actual production parts for the best possible results.

### B. Belt Installation

During the belt installation process, it is very important that the belt be fully seated in the sprocket grooves before applying final tension. Serpentine drives with multiple sprockets and drives with large sprockets are particularly vulnerable to belt tensioning problems resulting from the belt teeth being only partially engaged in the sprockets during installation. In order to prevent these problems, the belt installation tension should be evenly distributed to all belt spans by rotating the system by hand. After confirming that belt teeth are properly engaged in the sprocket grooves, belt tension should be re-checked and verified. Failure to do this may result in an under-tensioned condition with the potential for belt ratcheting.

### C. Belt Take-Up

Synchronous belt drives generally require little if any tensioning when used in accordance with proper design procedures. A small amount of belt tension decay can be expected within the first several hours of operation. After this time, the belt tension should remain relatively stable.

### D. Fixed Center Drives

Designers sometimes attempt to design synchronous belt drive systems without any means of belt adjustment or take up. This type of system is called a Fixed Center Drive. While this approach is often viewed as being economical, and is simple for assemblers, it often results in troublesome reliability and performance problems in the long run.

The primary pitfall in a fixed center design approach is failure to consider the affects of system tolerance accumulation. Belts and sprockets are manufactured with industry accepted production tolerances. There are limits to the accuracy that the

center distance can be maintained on a production basis as well. The potential effects of this tolerance accumulation is as follows:

#### Low Tension:

*Long Belt with Small Sprockets on a Short Center Distance*

#### High Tension:

*Short Belt with Large Sprockets on a Long Center Distance.*

Belt tension in these two cases can vary by a factor of 3 or more with a standard fiberglass tensile cord, and even more with an aramid tensile cord. This potential variation is great enough to overload bearings and shafting, as well as the belts themselves. The probability of these extremes occurring is a matter of statistics, but however remote the chances may seem, they will occur in a production setting. In power transmission drives, the appearance of either extreme is very likely to impact drive system performance in a negative manner.

The most detrimental aspect of fixed center drives is generally the potentially high tension condition. This condition can be avoided by adjusting the design center distance. A common approach in these designs is to reduce the center distance from the exact calculated value by some small fraction. This results in a drive system that is inherently loose, but one that has much less probability of yielding excessively high shaft loads.

**NOTE:** This approach should not be used for power transmission drives since the potentially loose operating conditions could result in accelerated wear and belt ratcheting, even under nominal loading.

There are times when fixed center drive designs can't be avoided. In these cases, the following recommendations will maximize the probability of success.

1. Do not use a fixed center design for power transmission drives. Consider using a fixed center design only for lightly loaded or motion transfer applications.
2. Do not use a fixed center design for drives requiring high motion quality or registration precision.
3. When considering a fixed center design, the center distance must be held as accurately as possible, typically within 0.002" – 0.003" (0.05mm – 0.08mm). This accuracy often requires the use of stamped steel framework.

Molding processes do not generally have the capability of maintaining the necessary accuracy.

4. Sprockets for fixed center systems should be produced with a machining process for accuracy. Molding and sintering processes are generally not capable of holding the finished O.D. with sufficient accuracy for these systems.
5. The performance capabilities of the drive system should be verified by testing belts produced over their full length tolerance range on drive systems representing the full potential center-distance variation. Contact Gates Product Application Engineering for further details.
6. Contact Gates Product Application Engineering for design center distance recommendations, and to review the application.

## V. Idler Usage

Idlers in synchronous belt drives are commonly used to take up belt slack, apply installation tension or to clear obstructions within a system. While idlers cause additional belt bending, resulting in fatigue, this effect is generally not significant as long as proper design procedures are followed. Synchronous belts elongate very little over time making them relatively maintenance free. All idlers should be capable of being locked down after being adjusted and should require little additional attention. Specific guidelines and recommendations follow in the upcoming paragraphs.

### A. Inside/Outside

Inside idlers are generally preferred over backside idlers from a belt fatigue standpoint. Both are commonly used with good success. Inside idlers should be sprockets, but can be flat if the O.D. is equivalent to the pitch diameter of a 40 groove sprocket. Backside idlers should be flat and uncrowned.

### B. Tight Side/Slack Side

Idlers should be placed on the slack (or non-load carrying) side if possible. Their affect on belt fatigue is less on the slack side than on the tight (or load carrying) side. If spring loaded idlers are used, they should never be placed on the tight side (see *D. Spring Loaded Idlers*). Also note that drive direction reversal causes the tight and slack spans to reverse, potentially placing the idler on the tight side.



## V. Idler Usage — continued

### C. Idler Placement

In synchronous belt drives, idlers can be placed nearly anywhere they are needed. Synchronous drives are much less sensitive to idler placement and belt wrap angles than V-belt drives. The designer should be sure that at least 6 belt teeth are in mesh on load carrying sprockets. For every tooth in mesh less than this (with a minimum of 2), 20% of the belt torque rating must be subtracted. In order to minimize the potential for belt ratcheting, each loaded sprocket in the system should also have a wrap angle of at least 60°. If a loaded sprocket has less than 6 teeth in mesh and 60° of wrap, idlers can often be used to improve this condition. Non-loaded idler sprockets do not have tooth meshing or wrap angle restrictions.

### D. Spring Loaded Idlers

Using a spring to apply a predetermined force against a tensioning idler to obtain proper belt installation tension is a common practice. The idler is typically locked down after belt installation. This provides a simple and repeatable process that works well in a production setting.

Dynamic spring loaded idlers are generally not recommended for synchronous belt drives. If used, spring-loaded idlers should never be used on the tight (or load carrying) side. Tight side tensions vary with the magnitude and type of load carried by the system. High tight side tensions can overcome the idler spring force allowing the belt to ratchet. In order to prevent this from occurring, an excessively high spring force is required. This high spring force can result in high shaft/bearing loads and accelerated belt wear.

Note that the tight and slack spans shift as the direction of drive rotation reverses. This could place the spring loaded idler on the tight side. For this reason, dynamic spring loaded idlers are never recommended for belt drive applications that reverse rotational direction. Also note that in some cases, drive vibration and harmonic problems may also be encountered with the use of spring loaded idlers.

Dynamic spring loaded idlers can be beneficial in some belt drive systems in that they maintain constant slack side span tension regardless of the magnitude of drive loads, and can actually reduce the potential of belt ratcheting. They can also be beneficial in applications with flexing or changing centers. If dynamic spring loaded idlers are to be used, they should always be used on the slack (or non-load carrying) side of the drive.

### E. Size Recommendations

Inside idler sprockets can be used in the minimum recommended size for each particular belt pitch. Inside flat idlers can be used on the tooth side of synchronous belts as long as they are of a diameter equivalent to the pitch diameter of a 40-groove sprocket in the same pitch. Drives with inside flat idlers should be tested, as noise and belt wear may occur.

Flat backside idlers should be used with diameters at least 30% larger than the minimum recommended inside sprocket size.

Table 9 summarizes our idler size recommendations.

**Table 9 – Idler Size Recommendations**

Belt	Minimum Inside Idler	Minimum Backside Idler	Minimum Inside Flat Idler
MXL	12 grooves	0.50" O.D.	1.00" O.D.
XL	12 grooves	1.00" O.D.	2.50" O.D.
3M HTD®	12 grooves	0.75" O.D.	1.50" O.D.
5M HTD	14 grooves	1.25" O.D.	2.50" O.D.
2MGT GT®3	12 grooves	0.50" O.D.	1.00" O.D.
3MGT GT 3	12 grooves	0.75" O.D.	1.50" O.D.
5MGT GT 3	14 grooves	1.25" O.D.	2.50" O.D.

Contact Gates Product Application Engineering for additional information.

### F. Specifying Shaft Locations in Multipoint Drive Layouts

When collecting geometrical layout data for multiple sprocket drive layouts, it is important to use a standard approach that is readily understood and usable for drive design calculations. This is of particular importance when the data will be provided to Gates Product Application Engineering for analysis.

### 2-Point Drive

When working with a simple 2-point drive (driveR/driveN only) it is sufficient to specify the desired distance between shaft centers for belt length calculations.

### 3-Point Drive

When working with a 3-point drive (driveR/driveN/idler), X-Y coordinates are desirable. It is sufficient, however, to specify desired center distances between each of the three shaft centers to form a triangle. In either case, sprocket/idler movement details for belt tensioning and take-up are also necessary.

### Multipoint Drive

When working with a drive system having more than 3 shafts, the geometrical layout data must be collected in terms of X-Y coordinates for analysis. For those unfamiliar with X-Y coordinates, the X-Y cartesian coordinate system is commonly used in mathematical and engineering calculations and utilizes a horizontal and vertical axis as illustrated in Figure 9.

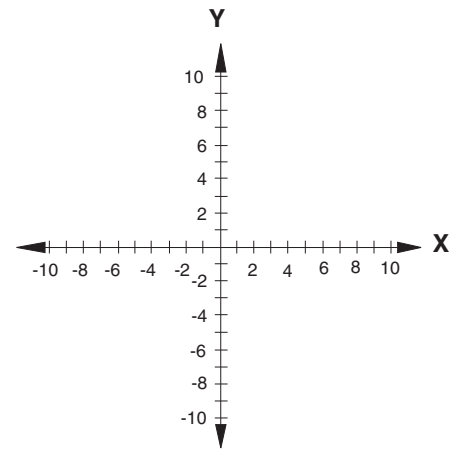

**Figure 9 - X-Y Coordinate Axis**

## V. Idler Usage – continued

The axes cross at the zero point, or origin. Along the horizontal, or “X” axis, all values to the right of the zero point are positive, and all values to the left of the zero point are negative. Along the vertical, or “Y” axis, all values above the zero point are positive, and all values below the zero point are negative. This is also illustrated in Figure 9 on page 68.

When identifying a shaft center location, each X-Y coordinate is specified with a measurement in the “X” as well as the “Y” direction. This requires a horizontal and vertical measurement for each shaft center in order to establish a complete coordinate. Either English or Metric units of measurement may be used.

A complete coordinate is specified as follows:

(X,Y) where X = measurement along X-axis (horizontal)  
Y = measurement along Y-axis (vertical)

In specifying X-Y coordinates for each shaft center, the origin (zero point) must first be chosen as a reference. The driveR shaft most often serves this purpose, but any shaft center can be used. Measurements for all remaining shaft centers must be taken from this origin or reference point. The origin is specified as (0,0).

An example layout of a 5-point drive system is illustrated in Figure 10. Here each of the five shaft centers are located and identified on the X-Y coordinate grid.

When specifying parameters for the moveable or adjustable shaft (for belt installation and tensioning), the following approaches are generally used:

**Fixed Location:** Specify the nominal shaft location coordinate with a movement direction.

**Slotted Location:** Specify a location coordinate for the beginning of the slot, and a location coordinate for the end of the slot along its path of linear movement.

**Pivoted Location:** Specify the initial shaft location coordinate along with a pivot point location coordinate and the pivot radius.

Performing belt length and idler movement/positioning calculations by hand can be quite difficult and time consuming. With a complete geometrical drive description, we can make the drive design and layout process quite simple for you. Contact Gates Product Application Engineering for computer-aided assistance.

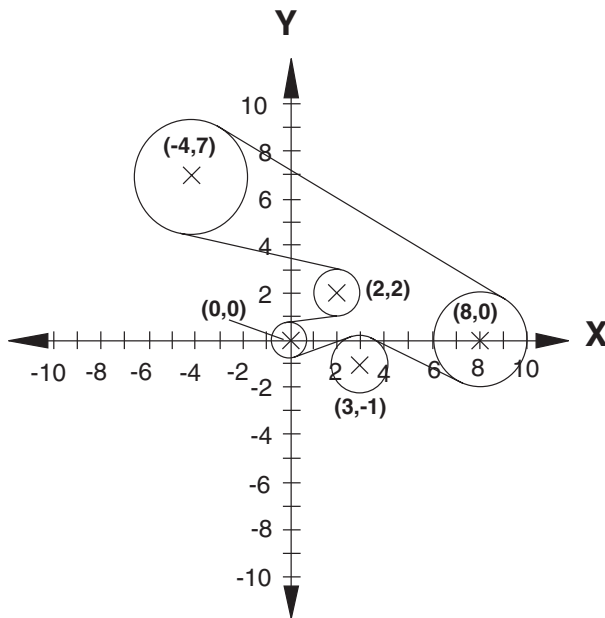

Figure 10 - Drive Layout Using X-Y Coordinates

## VI. Belt Pull

Synchronous belt drives are capable of exerting lower shaft loads than V-belt drives in some circumstances. If pre-tensioned according to Gates recommendations for a fully loaded steady state condition, synchronous and V-belt drives will generate comparable shaft loads. If the actual torque loads are reduced and the level of pre-tension remains the same, they will continue to exert comparable shaft loads. In some cases, synchronous belts can be pre-tensioned for less than full loads, under non-steady state conditions, with reasonable results. Reduced pre-tensioning in synchronous belts can be warranted in a system that operated with uniform loads most of the time, but generates peak loads on an intermittent basis. While V-belt drives require pre-tensioning based upon peak loads to prevent slippage, synchronous drive pre-tensioning can be based upon lower average loads rather than intermittent peak loads, so long as the belt does not ratchet under the peak loads. When the higher peak loads are carried by the synchronous drive, the belt will self-generate tension as needed to carry the load. The process of self-tensioning results in the belt teeth riding out of the sprocket grooves as the belt enters the driveN sprocket on the slack side, resulting in increased belt tooth and sprocket wear. So long as peak loads occur intermittently and belts do not ratchet, reduced installation tension will result in reduced average belt pull without serious detrimental effects. Synchronous belts generally require less pre-tension than V-belts for the same load. They do not require additional installation tension for belt wrap less than 180 degrees on loaded sprockets and V-belt drives do. In most cases, these factors contribute to lower static and dynamic shaft loads in synchronous belt drives.

Designers often wish to calculate how much force a belt drive will exert on a shafting/bearings/framework in order to properly design their system. It is difficult to make accurate belt pull calculations because factors such as torque load variation, installation tension and sprocket run-out all have a significant influence. Estimations, however, can be made as follows:

## VI. Belt Pull — continued

### A. Motion Transfer Drives

Motion transfer drives, by definition do not carry a significant torque load. As a result, the belt pull is dependent only on the installation tension. Because installation tensions are provided on a per-strand basis, the total belt pull can be calculated by vector addition.

### B. Power Transmission Drives

Torque load and installation tension both influence the belt pull in power transmission drives. The level of installation tension influences the dynamic tension ratio of the belt spans. The tension ratio is defined as the tight side (or load carrying) tension  $T_T$  divided by the slack side (or non-load carrying) tension  $T_S$ . Synchronous belt drives are generally pre-tensioned to operate dynamically at a 8:1 tension ratio in order to provide the best possible performance. After running for a short time, this ratio is known to increase somewhat as the belt runs in and seats with the sprockets reducing tension. Formula 5 and Formula 6 can be used to calculate the estimated  $T_T$  and  $T_S$  tensions assuming a 8:1 tension ratio.  $T_T$  and  $T_S$  tensions can then be summed into a single vector force and direction.

#### Formula 5

$$T_T = \frac{2.286(Q)}{Pd}, \text{ lb.}$$

#### Formula 6

$$T_S = \frac{0.285(Q)}{Pd}, \text{ lb.}$$

Where:  $T_T$  = Tight side tension, pounds  
 $T_S$  = Slack side tension, pounds  
 $Q$  = Torque Load, pound inches  
 $Pd$  = Pitch diameter, inches

If both direction and magnitude of belt pull are required, the vector sum of  $T_T$  and  $T_S$  can be found by graphical vector addition as shown in Fig. 11.  $T_T$  and  $T_S$  vectors are drawn parallel to the tight and slack sides at a convenient scale. The magnitude and direction of the resultant vector, or belt pull, can then be measured graphically. The same procedures can be used for finding belt pull on the driveN shaft. This method can also be used for drives using three or more sprockets or idlers.

For two sprocket drives, belt pull on the driveR and

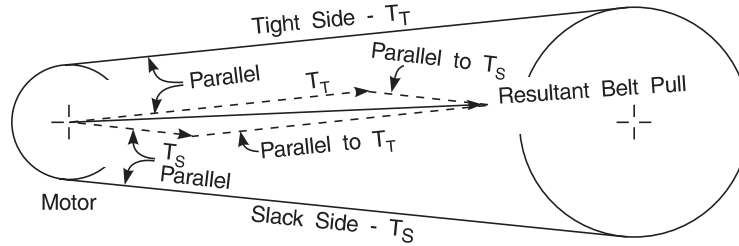

Figure 11 - Vector Addition

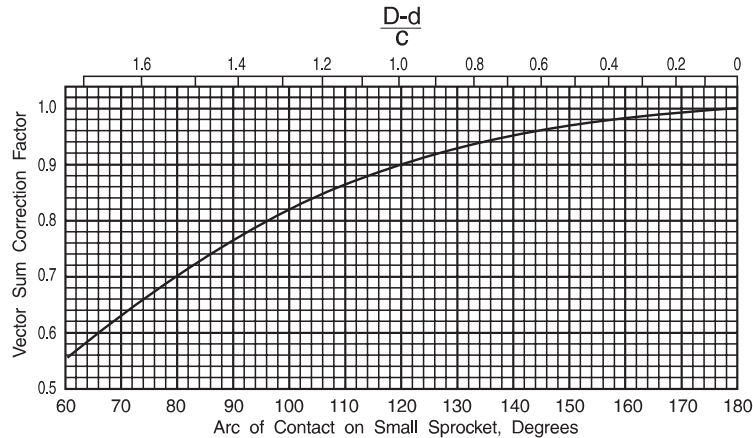

Figure 12 - Vector Sum Correction Factor

driveN shafts is equal but opposite in direction. For drives using idlers, both magnitude and direction may be different. If only the magnitude of the belt pull is needed in a two sprocket drive, use the following procedure.

1. Add  $T_T$  and  $T_S$
2. Using the value of  $(D-d)/C$  for the drive, find the vector sum correction factor using Fig. 12. Or, use the known arc of contact on the small sprocket where:
  - $D$  = large diameter
  - $d$  = small diameter
  - $C$  = center distance

3. Multiply the sum of  $T_T$  and  $T_S$  by the vector sum correction factor to find the vector sum, or belt pull.

For drives using idlers, either use the graphical method or contact Gates Product Application Engineering for assistance.

### C. Registration Drives

Synchronous belt drives used for purposes of accurate registration or synchronization generally require the use of higher than normal installation tensions (see section III. *Belt Tensioning*, pages 64-66). These drives will operate with higher belt pulls than normal power transmission drives. Belt pull values for these types of applications should be verified experimentally, but can be estimated by adding the installation tension in each belt span vectorially.

For guidance in calculating bearing loads, see *Bearing Load Calculations* on page 102.

# Synchronous Belt Drives – Engineering

## VII. Handling And Storage

The following has been condensed from ARPM (formerly RMA) Bulletin No. IP-3-4; "Storage Of Power Transmission Belts".

Recommendations for proper belt storage is of interest to designers as well as to users. Under favorable storage conditions, high quality belts maintain their performance capabilities and manufactured dimensions. Good storage conditions and practices will result in the best value from belt products.



Power transmission belts should ideally be stored in a cool and dry environment. Excess weight against belts resulting in distortion should be avoided. Avoid storing belts in environments that may allow exposure to sunlight, moisture, excessive heat, ozone, or where evaporating solvents or other chemicals are present. Belts have been found to be capable of withstanding storage, without changing significantly, for as long as 8 years at temperatures less than 85°F (30°C) and relative humidity below 70 percent without direct contact with sunlight.

Proper handling of synchronous belts is also important in preventing damage that could reduce their performance capabilities. Synchronous belts should never be crimped or tightly bent. Belts should not be bent tighter than the minimum recommended sprocket size specified for each belt section, or pitch. Belt backside bending should be limited to the values specified in Table 9 on Page 68.

## VIII. Special Constructions

In addition to the standard PowerGrip® belt products listed in this catalog, there are many special belts available on a made-to-order basis. These non-standard belts can be helpful when used in unusual applications, or when the designer has special performance requirements. See Table 10 for general made-to-order manufacturing capabilities. Contact Gates Product Application Engineering for additional information.

**Table 10 – Made-To-Order Belt Constructions**

Type of MTO Belt	Application	Tooth Profiles Available
Nonstock widths and/or lengths with tooling available	When exact length is required	
High temperature	Dry operation from -40°F to 225°F (-40°C to 107°C)	PowerGrip® GT® 
Low temperature	Dry operation from -65°F to 175°F (-54°C to 79°C)	
Oil resistant	For excessively oily atmospheres, including immersion in commercial motor oil. Temperature range: dry -40°F to 210°F (-40°C to 99°C)	PowerGrip® HTD® 
Static conductive (Static dissipating)	Resistance of 300,000 ohms or less to dissipate static charge	
Nonconductive	When electrical isolation within a system is required. Conductivity properties per customer requirements	
Nonmarking backing	For conveyers or material handling processes	
Extra-thick rubber backing	For special applications where the belt backing serves a functional purpose	PowerGrip® Timing 
Ground backing	For sensitive applications requiring minimal vibration from outside idlers	
Alternate tensile cord	For special tensile modulus, bending flexibility or durability requirements	
Special tracking	When belt must track in a particular direction	

# Synchronous Belt Drives – Belt Specifications

## General Belt Tolerances

Gates belt length and width tolerances for synchronous belts are based upon industry standard ARPM (Association of Rubber Product Manufacturers—Formerly RMA) tolerances.

**Table 11 – Center Distance Tolerances – Single Sided Belts**

Belt Length		Center Distance Tolerance	
(in)	(mm)	(in)	(mm)
Up to 10	254	±.008	±.20
Over 10	254	±.009	±.23
To 15	381		
Over 15	381	±.010	±.25
To 20	508		
Over 20	508	±.012	±.30
To 30	762		
Over 30	762	±.013	±.33
To 40	1016		
Over 40	1016	±.015	±.38
To 50	1270		
Over 50	1270	±.016	±.41
To 60	1524		
Over 60	1524	±.017	±.43
To 70	1778		
Over 70	1778	±.018	±.46
To 80	2032		
Over 80	2032	±.019	±.48
To 90	2286		
Over 90	2286	±.020	±.51
To 100	2540		
Over 100	2540	±.021	±.53
To 110	2794		
Over 110	2794	±.022	±.56
To 120	3048		

**Table 12 – Center Distance Tolerances – Twin Power Belts**

Belt Length (in)	Tolerance Center Distance (in)
15 to 20	±.020
20.01 to 30	±.024
30.01 to 40	±.026
40.01 to 50	±.030
50.01 to 60	±.032
60.01 to 70	±.034
over 70	To be specified

**Table 13 – Belt Width Tolerances – Single Sided & Twin Power Belts**

Belt Width (in) (mm)		Belt Length					
		0 to 33 in. (0 to 838mm)		33.01 to 66 in. (839 to 1676mm)		Over 66 in. (1676mm)	
(in)	(mm)	(in)	(mm)	(in)	(mm)	(in)	(mm)
From 0.125	3	+0.016	+0.4	+0.016	+0.4	-	-
To 0.438	11	-0.031	-0.8	-0.031	-0.8	-	-
Over 0.438	11	+0.031	+0.8	+0.031	+0.8	+0.031	+0.8
To 1.500	38.1	-0.031	-0.8	-0.047	-1.2	-0.047	-1.2
Over 1.500	38.1	+0.031	+0.8	+0.047	+1.2	+0.047	+1.2
To 2.000	50.8	-0.047	-1.2	-0.047	-1.2	-0.063	-1.6

**Table 14 – Belt Width Tolerances – Long-Length Belting**

	Belt Width Tolerance
All Spiral Cut Belting	+ 0.031" – 0.047" +0.8mm –1.2mm

**Table 15 – Overall Belt Thickness Dimensions**

Pitch Code	Belt Pitch	Overall Thickness (ref)	
		(in)	(mm)
2MGT GT3	2mm	.060	1.52
3MGT GT3	3mm	.095	2.41
5MGT GT3	5mm	.150	3.81
3M HTD	3mm	.095	2.41
5M HTD	5mm	.150	3.81
MXL	.080 in.	.045	1.14
XL	.200 in.	.090	2.29

**Table 16 – Overall Belt Thickness Tolerance – Single Sided Belts**

Standard	Class 2	Class 1
±0.015 in.	±0.010 in.	±0.005 in.
±0.38mm	±0.25mm	±0.13mm

**NOTE:** Belts with pitch lengths greater than 5.5 in. (140mm) are furnished with a Class II grind unless otherwise specified. Belts with pitch lengths less than 5.5 in. (140mm) are unground and produced to standard tolerances.

**NOTE:** A class 1 grind is available at additional cost for finished belts only.

**Table 17 – Overall Belt Thickness Dimensions – Twin Power Belts**

Pitch	T (in)	W (in) (Reference)
3M GT2	.120 ±.006	.030
5M GT2	.197 ±.007	.045
3M HTD	.126 ±.006	.030
5M HTD	.209 ±.007	.045
XL (.200 in)	.120 ±.007	.020

# Synchronous Belt Drives – Sprocket Specifications

## Sprocket Specifications

### — A. Sprocket Diameters

2mm Pitch Sprocket Diameters — PowerGrip® GT <sup>3</sup>																	
No. of Grooves	Diameters		No. of Grooves	mm (in)		No. of Grooves	Diameters		No. of Grooves	mm (in)		No. of Grooves	Diameters		No. of Grooves	mm (in)	
	P.D.	O.D.		P.D.	O.D.		P.D.	O.D.		P.D.	O.D.		P.D.	O.D.		P.D.	O.D.
12	7.64 0.301	7.13 0.281	42	26.74 1.053	26.23 1.033	72	45.84 1.805	45.33 1.785	102	64.94 2.557	64.43 2.537	132	84.03 3.308	83.53 3.288			
13	8.28 0.326	7.77 0.306	43	27.37 1.078	26.87 1.058	73	46.47 1.830	45.97 1.810	103	65.57 2.582	65.06 2.562	133	84.67 3.333	84.16 3.313			
14	8.91 0.351	8.40 0.331	44	28.01 1.103	27.50 1.083	74	47.11 1.855	46.60 1.835	104	66.21 2.607	65.70 2.587	134	85.31 3.359	84.80 3.339			
15	9.55 0.376	9.04 0.356	45	28.65 1.128	28.14 1.108	75	47.75 1.880	47.24 1.860	105	66.85 2.632	66.34 2.612	135	85.94 3.384	85.44 3.364			
16	10.19 0.401	9.68 0.381	46	29.28 1.153	28.78 1.133	76	48.38 1.905	47.88 1.885	106	67.48 2.657	66.97 2.637	136	86.58 3.409	86.07 3.389			
17	10.82 0.426	10.31 0.406	47	29.92 1.178	29.41 1.158	77	49.02 1.930	48.51 1.910	107	68.12 2.682	67.61 2.662	137	87.22 3.434	86.71 3.414			
18	11.46 0.451	10.95 0.431	48	30.56 1.203	30.05 1.183	78	49.66 1.955	49.15 1.935	108	68.75 2.707	68.25 2.687	138	87.85 3.459	87.35 3.439			
19	12.10 0.476	11.59 0.456	49	31.19 1.228	30.69 1.208	79	50.29 1.980	49.79 1.960	109	69.39 2.732	68.88 2.712	139	88.49 3.484	87.98 3.464			
20	12.73 0.501	12.22 0.481	50	31.83 1.253	31.32 1.233	80	50.93 2.005	50.42 1.985	110	70.03 2.757	69.52 2.737	140	89.13 3.509	88.62 3.489			
21	13.37 0.526	12.86 0.506	51	32.47 1.278	31.96 1.258	81	51.57 2.030	51.06 2.010	111	70.66 2.782	70.16 2.762	141	89.76 3.534	89.26 3.514			
22	14.01 0.551	13.50 0.531	52	33.10 1.303	32.60 1.283	82	52.20 2.055	51.69 2.035	112	71.30 2.807	70.79 2.787	142	90.40 3.559	89.89 3.539			
23	14.64 0.576	14.13 0.556	53	33.74 1.328	33.23 1.308	83	52.84 2.080	52.33 2.060	113	71.94 2.832	71.43 2.812	143	91.04 3.584	90.53 3.564			
24	15.28 0.602	14.77 0.582	54	34.38 1.353	33.87 1.333	84	53.48 2.105	52.97 2.085	114	72.57 2.857	72.07 2.837	144	91.67 3.609	91.17 3.589			
25	15.92 0.627	15.41 0.607	55	35.01 1.379	34.51 1.359	85	54.11 2.130	53.60 2.110	115	73.21 2.882	72.70 2.862	145	92.31 3.634	91.80 3.614			
26	16.55 0.652	16.04 0.632	56	35.65 1.404	35.14 1.384	86	54.75 2.155	54.24 2.135	116	73.85 2.907	73.34 2.887	146	92.95 3.659	92.44 3.639			
27	17.19 0.677	16.68 0.657	57	36.29 1.429	35.78 1.409	87	55.39 2.181	54.88 2.161	117	74.48 2.932	73.98 2.912	147	93.58 3.684	93.08 3.664			
28	17.83 0.702	17.32 0.682	58	36.92 1.454	36.42 1.434	88	56.02 2.206	55.51 2.186	118	75.12 2.958	74.61 2.938	148	94.22 3.709	93.71 3.689			
29	18.46 0.727	17.95 0.707	59	37.56 1.479	37.05 1.459	89	56.66 2.231	56.15 2.211	119	75.76 2.983	75.25 2.963	149	94.86 3.735	94.35 3.715			
30	19.10 0.752	18.59 0.732	60	38.20 1.504	37.69 1.484	90	57.30 2.256	56.79 2.236	120	76.39 3.008	75.89 2.988	150	95.49 3.760	94.99 3.740			
31	19.74 0.777	19.23 0.757	61	38.83 1.529	38.33 1.509	91	57.93 2.281	57.42 2.261	121	77.03 3.033	76.52 3.013	151	96.13 3.785	95.62 3.765			
32	20.37 0.802	19.86 0.782	62	39.47 1.554	38.96 1.534	92	58.57 2.306	58.06 2.286	122	77.67 3.058	77.16 3.038	152	96.77 3.810	96.26 3.790			
33	21.01 0.827	20.50 0.807	63	40.11 1.579	39.60 1.559	93	59.21 2.331	58.70 2.311	123	78.30 3.083	77.80 3.063	153	97.40 3.835	96.89 3.815			
34	21.65 0.852	21.14 0.832	64	40.74 1.604	40.24 1.584	94	59.84 2.356	59.33 2.336	124	78.94 3.108	78.43 3.088	154	98.04 3.860	97.53 3.840			
35	22.28 0.877	21.77 0.857	65	41.38 1.629	40.87 1.609	95	60.48 2.381	59.97 2.361	125	79.58 3.133	79.07 3.113	155	98.68 3.885	98.17 3.865			
36	22.92 0.902	22.41 0.882	66	42.02 1.654	41.51 1.634	96	61.12 2.406	60.61 2.386	126	80.21 3.158	79.71 3.138	156	99.31 3.910	98.80 3.890			
37	23.55 0.927	23.05 0.907	67	42.65 1.679	42.15 1.659	97	61.75 2.431	61.24 2.411	127	80.85 3.183	80.34 3.163	157	99.95 3.935	99.44 3.915			
38	24.19 0.952	23.68 0.932	68	43.29 1.704	42.78 1.684	98	62.39 2.456	61.88 2.436	128	81.49 3.208	80.98 3.188	158	100.59 3.960	100.08 3.940			
39	24.83 0.977	24.32 0.957	69	43.93 1.729	43.42 1.709	99	63.03 2.481	62.52 2.461	129	82.12 3.233	81.62 3.213	159	101.22 3.985	100.71 3.965			
40	25.46 1.003	24.96 0.983	70	44.56 1.754	44.06 1.734	100	63.66 2.506	63.15 2.486	130	82.76 3.258	82.25 3.238	160	101.86 4.010	101.35 3.990			
41	26.10 1.028	25.59 1.008	71	45.20 1.780	44.69 1.760	101	64.30 2.531	63.79 2.511	131	83.40 3.283	82.89 3.263						

See Page 77 for sprocket O.D. tolerances.





# Synchronous Belt Drives – Sprocket Specifications

## Sprocket Specifications – continued

### 3mm Pitch Sprocket Diameters – PowerGrip® GT®3 and HTD®

No. of Grooves	Diameters		No. of Grooves	Diameters		No. of Grooves	Diameters		No. of Grooves	Diameters		No. of Grooves	Diameters	
	P.D.	mm (in)		P.D.	mm (in)		P.D.	mm (in)		P.D.	mm (in)		P.D.	mm (in)
*12	11.46 .451	10.70 .421	42	40.11 1.579	39.35 1.549	72	68.75 2.707	67.99 2.677	102	97.40 3.835	96.64 3.805	132	126.05 4.963	125.29 4.933
*13	12.41 .489	11.65 .459	43	41.06 1.617	40.30 1.587	73	69.71 2.744	68.95 2.714	103	98.36 3.872	97.60 3.842	133	127.01 5.000	126.25 4.970
*14	13.37 .526	12.61 .496	44	42.02 1.654	41.26 1.624	74	70.66 2.782	69.90 2.752	104	99.31 3.910	98.55 3.880	134	127.96 5.038	127.20 5.008
*15	14.32 .564	13.56 .534	45	42.97 1.692	42.21 1.662	75	71.62 2.820	70.86 2.790	105	100.27 3.948	99.51 3.918	135	128.92 5.075	128.16 5.045
16	15.28 .602	14.52 .572	46	43.93 1.729	43.17 1.699	76	72.57 2.857	71.81 2.827	106	101.22 3.985	100.46 3.955	136	129.87 5.113	129.11 5.083
17	16.23 .639	15.47 .609	47	44.88 1.767	44.12 1.737	77	73.53 2.895	72.77 2.865	107	102.18 4.023	101.42 3.993	137	130.83 5.151	130.07 5.121
18	17.19 .677	16.43 .647	48	45.84 1.805	45.08 1.775	78	74.48 2.932	73.72 2.902	108	103.13 4.060	102.37 4.030	138	131.78 5.188	131.02 5.158
19	18.14 .714	17.38 .684	49	46.79 1.842	46.03 1.812	79	75.44 2.970	74.68 2.940	109	104.09 4.098	103.33 4.068	139	132.74 5.226	131.98 5.196
20	19.10 .752	18.34 .722	50	47.75 1.880	46.99 1.850	80	76.39 3.008	75.63 2.978	110	105.04 4.136	104.28 4.106	140	133.69 5.263	132.93 5.233
21	20.05 .790	19.29 .760	51	48.70 1.917	47.94 1.887	81	77.35 3.045	76.59 3.015	111	106.00 4.173	105.24 4.143	141	134.65 5.301	133.89 5.271
22	21.01 .827	20.25 .797	52	49.66 1.955	48.90 1.925	82	78.30 3.083	77.54 3.053	112	106.95 4.211	106.19 4.181	142	135.60 5.339	134.84 5.309
23	21.96 .865	21.20 .835	53	50.61 1.993	49.85 1.963	83	79.26 3.120	78.50 3.090	113	107.91 4.248	107.15 4.218	143	136.55 5.376	135.79 5.346
24	22.92 .902	22.16 .872	54	51.57 2.030	50.81 2.000	84	80.21 3.158	79.45 3.128	114	108.86 4.286	108.10 4.256	144	137.51 5.414	136.75 5.384
25	23.87 .940	23.11 .910	55	52.52 2.068	51.76 2.038	85	81.17 3.196	80.41 3.166	115	109.82 4.324	109.06 4.294	145	138.46 5.451	137.70 5.421
26	24.83 .977	24.07 .947	56	53.48 2.105	52.72 2.075	86	82.12 3.233	81.36 3.203	116	110.77 4.361	110.01 4.331	146	139.42 5.489	138.66 5.459
27	25.78 1.015	25.02 .985	57	54.43 2.143	53.67 2.113	87	83.08 3.271	82.32 3.241	117	111.73 4.399	110.97 4.369	147	140.37 5.527	139.61 5.497
28	26.74 1.053	25.98 1.023	58	55.39 2.181	54.63 2.151	88	84.03 3.308	83.27 3.278	118	112.68 4.436	111.92 4.406	148	141.33 5.564	140.57 5.534
29	27.69 1.090	26.93 1.060	59	56.34 2.218	55.58 2.188	89	84.99 3.346	84.23 3.316	119	113.64 4.474	112.88 4.444	149	142.28 5.602	141.52 5.572
30	28.65 1.128	27.89 1.098	60	57.30 2.256	56.54 2.226	90	85.94 3.384	85.18 3.354	120	114.59 4.511	113.83 4.481	150	143.24 5.639	142.48 5.609
31	29.60 1.165	28.84 1.135	61	58.25 2.293	57.49 2.263	91	86.90 3.421	86.14 3.391	121	115.55 4.549	114.79 4.519	151	144.19 5.677	143.43 5.647
32	30.56 1.203	29.80 1.173	62	59.21 2.331	58.45 2.301	92	87.85 3.459	87.09 3.429	122	116.50 4.587	115.74 4.557	152	145.15 5.715	144.39 5.685
33	31.51 1.241	30.75 1.211	63	60.16 2.369	59.40 2.339	93	88.81 3.496	88.05 3.462	123	117.46 4.624	116.70 4.594	153	146.10 5.752	145.34 5.722
34	32.47 1.278	31.71 1.248	64	61.12 2.406	60.36 2.376	94	89.76 3.534	89.00 3.504	124	118.41 4.662	117.65 4.632	154	147.06 5.790	146.30 5.760
35	33.42 1.316	32.66 1.286	65	62.07 2.444	61.31 2.414	95	90.72 3.572	89.96 3.542	125	119.37 4.699	118.61 4.669	155	148.01 5.827	147.25 5.797
36	34.38 1.353	33.62 1.323	66	63.03 2.481	62.27 2.451	96	91.67 3.609	90.91 3.579	126	120.32 4.737	119.56 4.707	156	148.97 5.865	148.21 5.835
37	35.33 1.391	34.57 1.361	67	63.98 2.519	63.22 2.489	97	92.63 3.647	91.87 3.617	127	121.28 4.775	120.52 4.745	157	149.92 5.903	149.16 5.873
38	36.29 1.429	35.53 1.399	68	64.94 2.557	64.18 2.527	98	93.58 3.684	92.82 3.654	128	122.23 4.812	121.47 4.782	158	150.88 5.940	150.12 5.910
39	37.24 1.466	36.48 1.436	69	65.89 2.594	65.13 2.564	99	94.54 3.722	93.78 3.692	129	123.19 4.850	122.43 4.820	159	151.83 5.978	151.07 5.948
40	38.20 1.504	37.44 1.474	70	66.85 2.632	66.09 2.602	100	95.49 3.760	94.73 3.730	130	124.14 4.887	123.38 4.857	160	152.79 6.015	152.03 5.985
41	39.15 1.541	38.39 1.511	71	67.80 2.669	67.04 2.639	101	96.45 3.797	95.69 3.767	131	125.10 4.925	124.34 4.895			

\*Denotes subminimal diameters not recommended for PowerGrip® GT®3.

NOTE: See Page 77 for sprocket O.D. tolerances.

NOTE: PowerGrip® GT®3 and PowerGrip HTD sprockets are incompatible.

Use PowerGrip® GT®3 belts with PowerGrip® GT®3 sprockets, and PowerGrip HTD belts with PowerGrip HTD sprockets.

# Synchronous Belt Drives – Sprocket Specifications

## Sprocket Specifications — continued

5mm Pitch Sprocket Diameters – PowerGrip® GT®3 and HTD®														
No. of Grooves	Diameters		No. of Grooves	Diameters		No. of Grooves	Diameters		No. of Grooves	Diameters		No. of Grooves	Diameters	
	P.D.	mm (in)		P.D.	mm (in)		P.D.	mm (in)		P.D.	mm (in)		P.D.	mm (in)
*14	22.28 .877	21.14 .832	44	70.03 2.757	68.89 2.712	74	117.77 4.637	116.63 4.592	104	165.52 6.517	164.38 6.472	134	213.27 8.396	212.13 8.351
*15	23.87 .940	22.73 .895	45	71.62 2.820	70.48 2.775	75	119.37 4.699	118.23 4.654	105	167.11 6.579	165.97 6.534	135	214.86 8.459	213.72 8.414
*16	25.46 1.003	24.32 .958	46	73.21 2.882	72.07 2.837	76	120.96 4.762	119.82 4.717	106	168.70 6.642	167.56 6.597	136	216.45 8.522	215.31 8.477
*17	27.06 1.065	25.92 1.020	47	74.80 2.945	73.66 2.900	77	122.55 4.825	121.41 4.780	107	170.30 6.705	169.16 6.660	137	218.04 8.584	216.90 8.539
18	28.65 1.128	27.51 1.083	48	76.39 3.008	75.25 2.963	78	124.14 4.887	123.00 4.842	108	171.89 6.767	170.75 6.722	138	219.63 8.647	218.49 8.602
19	30.24 1.191	29.10 1.146	49	77.99 3.070	76.85 3.025	79	125.73 4.950	124.59 4.905	109	173.48 6.830	172.34 6.785	139	221.23 8.710	220.09 8.665
20	31.83 1.253	30.69 1.208	50	79.58 3.133	78.44 3.088	80	127.32 5.013	126.18 4.968	110	175.07 6.893	173.93 6.848	140	222.82 8.772	221.68 8.727
21	33.42 1.316	32.28 1.271	51	81.17 3.196	80.03 3.151	81	128.92 5.075	127.78 5.030	111	176.66 6.955	175.52 6.910	141	224.41 8.835	223.27 8.790
22	35.01 1.379	33.87 1.334	52	82.76 3.258	81.62 3.213	82	130.51 5.138	129.37 5.093	112	178.25 7.018	177.11 6.973	142	226.00 8.898	224.86 8.853
23	36.61 1.441	35.47 1.396	53	84.35 3.321	83.21 3.276	83	132.10 5.201	130.96 5.156	113	179.85 7.081	178.71 7.036	143	227.59 8.960	226.45 8.915
24	38.20 1.504	37.06 1.459	54	85.94 3.384	84.80 3.339	84	133.69 5.263	132.55 5.218	114	181.44 7.143	180.30 7.098	144	229.18 9.023	228.04 8.978
25	39.79 1.566	38.65 1.521	55	87.54 3.446	86.40 3.401	85	135.28 5.326	134.14 5.281	115	183.03 7.206	181.89 7.161	145	230.77 9.086	229.63 9.041
26	41.38 1.629	40.24 1.584	56	89.13 3.509	87.99 3.464	86	136.87 5.389	135.73 5.344	116	184.62 7.268	183.48 7.223	146	232.37 9.148	231.23 9.103
27	42.97 1.692	41.83 1.647	57	90.72 3.572	89.58 3.527	87	138.46 5.451	137.32 5.406	117	186.21 7.331	185.07 7.286	147	233.96 9.211	232.82 9.166
28	44.56 1.754	43.42 1.709	58	92.31 3.634	91.17 3.589	88	140.06 5.514	138.92 5.469	118	187.80 7.394	186.66 7.349	148	235.55 9.274	234.41 9.229
29	46.15 1.817	45.01 1.772	59	93.90 3.697	92.76 3.652	89	141.65 5.577	140.51 5.532	119	189.39 7.456	188.25 7.411	149	237.14 9.336	236.00 9.291
30	47.75 1.880	46.61 1.835	60	95.49 3.760	94.35 3.715	90	143.24 5.639	142.10 5.594	120	190.99 7.519	189.85 7.474	150	238.73 9.399	237.59 9.354
31	49.34 1.942	48.20 1.897	61	97.08 3.822	95.94 3.777	91	144.83 5.702	143.69 5.657	121	192.58 7.582	191.44 7.537	151	240.32 9.462	239.18 9.417
32	50.93 2.005	49.79 1.960	62	98.68 3.885	97.54 3.840	92	146.42 5.765	145.28 5.720	122	194.17 7.644	193.03 7.599	152	241.92 9.524	240.78 9.479
33	52.52 2.068	51.38 2.023	63	100.27 3.948	99.13 3.903	93	148.01 5.827	146.87 5.782	123	195.76 7.707	194.62 7.662	153	243.51 9.587	242.37 9.542
34	54.11 2.130	52.97 2.085	64	101.86 4.010	100.72 3.965	94	149.61 5.890	148.47 5.845	124	197.35 7.770	196.21 7.725	154	245.10 9.650	243.96 9.605
35	55.70 2.193	54.56 2.148	65	103.45 4.073	102.31 4.028	95	151.20 5.953	150.06 5.908	125	198.94 7.832	197.80 7.787	155	246.69 9.712	245.55 9.667
36	57.30 2.256	56.16 2.211	66	105.04 4.136	103.90 4.091	96	152.79 6.015	151.65 5.970	126	200.54 7.895	199.40 7.850	156	248.28 9.775	247.14 9.730
37	58.89 2.318	57.75 2.273	67	106.63 4.198	105.49 4.153	97	154.38 6.078	153.24 6.033	127	202.13 7.958	200.99 7.913	157	249.87 9.838	248.73 9.793
38	60.48 2.381	59.34 2.336	68	108.23 4.261	107.09 4.216	98	155.97 6.141	154.83 6.096	128	203.72 8.020	202.58 7.975	158	251.46 9.900	250.32 9.855
39	62.07 2.444	60.93 2.399	69	109.82 4.324	108.68 4.279	99	157.56 6.203	156.42 6.158	129	205.31 8.083	204.17 8.038	159	253.06 9.963	251.92 9.918
40	63.66 2.506	62.52 2.461	70	111.41 4.386	110.27 4.341	100	159.15 6.266	158.01 6.221	130	206.90 8.146	205.76 8.101	160	254.65 10.026	253.51 9.981
41	65.25 2.569	64.11 2.524	71	113.00 4.449	111.86 4.404	101	160.75 6.329	159.61 6.284	131	208.49 8.208	207.35 8.163			
42	66.85 2.632	65.71 2.587	72	114.59 4.511	113.45 4.466	102	162.34 6.391	161.20 6.346	132	210.08 8.271	208.94 8.226			
43	68.44 2.694	67.30 2.649	73	116.18 4.574	115.04 4.529	103	163.93 6.454	162.79 6.409	133	211.68 8.334	210.54 8.289			

\*Denotes subminimal diameters not recommended for PowerGrip® GT®3.

**NOTE:** See Page 77 for sprocket O.D. tolerances.

**NOTE:** PowerGrip® GT®3 and PowerGrip HTD sprockets are incompatible.

Use PowerGrip® GT®3 belts with PowerGrip® GT®3 sprockets, and PowerGrip HTD belts with PowerGrip HTD sprockets.



# Synchronous Belt Drives – Sprocket Specifications

## Sprocket Specifications – continued

### MXL (.080 in) Pitch Pulley Diameters

No. of Grooves	Dimensions (in)		No. of Grooves	Dimensions (in)		No. of Grooves	Dimensions (in)		No. of Grooves	Dimensions (in)		No. of Grooves	Dimensions (in)	
	P.D.	O.D.		P.D.	O.D.		P.D.	O.D.		P.D.	O.D.		P.D.	O.D.
10	.255	.235	39	.993	.973	68	1.731	1.711	97	2.470	2.450	126	3.209	3.189
11	.280	.260	40	1.019	.999	69	1.757	1.737	98	2.496	2.476	127	3.234	3.214
12	.306	.286	41	1.044	1.024	70	1.783	1.763	99	2.521	2.501	128	3.259	3.239
13	.331	.311	42	1.070	1.050	71	1.808	1.788	100	2.546	2.526	129	3.285	3.265
14	.357	.337	43	1.095	1.075	72	1.833	1.813	101	2.572	2.552	130	3.310	3.290
15	.382	.362	44	1.120	1.100	73	1.859	1.839	102	2.597	2.577	131	3.336	3.316
16	.407	.387	45	1.146	1.126	74	1.884	1.864	103	2.623	2.603	132	3.361	3.341
17	.433	.413	46	1.171	1.151	75	1.910	1.890	104	2.648	2.628	133	3.387	3.367
18	.458	.438	47	1.197	1.177	76	1.935	1.915	105	2.674	2.654	134	3.412	3.392
19	.484	.464	48	1.222	1.202	77	1.961	1.941	106	2.699	2.679	135	3.438	3.418
20	.509	.489	49	1.248	1.228	78	1.986	1.966	107	2.725	2.705	136	3.463	3.443
21	.535	.515	50	1.273	1.253	79	2.012	1.992	108	2.750	2.730	137	3.489	3.469
22	.560	.540	51	1.299	1.279	80	2.037	2.017	109	2.776	2.756	138	3.514	3.494
23	.586	.566	52	1.324	1.304	81	2.063	2.043	110	2.801	2.781	139	3.540	3.520
24	.611	.591	53	1.350	1.330	82	2.088	2.068	111	2.827	2.807	140	3.565	3.545
25	.637	.617	54	1.375	1.355	83	2.114	2.094	112	2.852	2.832	141	3.591	3.571
26	.662	.642	55	1.401	1.381	84	2.139	2.119	113	2.878	2.858	142	3.616	3.596
27	.687	.667	56	1.426	1.406	85	2.165	2.145	114	2.903	2.883	143	3.641	3.621
28	.713	.693	57	1.451	1.431	86	2.190	2.170	115	2.928	2.908	144	3.667	3.647
29	.738	.718	58	1.477	1.457	87	2.215	2.195	116	2.954	2.934	145	3.692	3.672
30	.764	.744	59	1.502	1.482	88	2.241	2.221	117	2.979	2.959	146	3.718	3.698
31	.789	.769	60	1.528	1.508	89	2.266	2.246	118	3.005	2.985	147	3.743	3.723
32	.815	.795	61	1.553	1.533	90	2.292	2.272	119	3.030	3.010	148	3.769	3.749
33	.840	.820	62	1.579	1.559	91	2.317	2.297	120	3.056	3.036	149	3.794	3.774
34	.866	.846	63	1.604	1.584	92	2.343	2.323	121	3.081	3.061	150	3.820	3.800
35	.891	.871	64	1.630	1.610	93	2.368	2.348	122	3.107	3.087			
36	.917	.897	65	1.655	1.635	94	2.394	2.374	123	3.132	3.112			
37	.942	.922	66	1.681	1.661	95	2.419	2.399	124	3.158	3.138			
38	.968	.948	67	1.706	1.686	96	2.445	2.425	125	3.183	3.163			

NOTE: See Page 77 for sprocket O.D. tolerances.

### XL (.200 in) Pitch Pulley Diameters

No. of Grooves	Dimensions (in)		No. of Grooves	Dimensions (in)		No. of Grooves	Dimensions (in)		No. of Grooves	Dimensions (in)		No. of Grooves	Dimensions (in)	
	P.D.	O.D.		P.D.	O.D.		P.D.	O.D.		P.D.	O.D.		P.D.	O.D.
10	.637	.617	33	2.101	2.081	56	3.565	3.545	79	5.029	5.009	102	6.494	6.474
11	.700	.680	34	2.165	2.145	57	3.629	3.609	80	5.093	5.073	103	6.557	6.537
12	.764	.744	35	2.228	2.208	58	3.692	3.672	81	5.157	5.137	104	6.621	6.601
13	.828	.808	36	2.292	2.272	59	3.756	3.736	82	5.220	5.200	105	6.685	6.665
14	.891	.871	37	2.355	2.335	60	3.820	3.800	83	5.284	5.264	106	6.748	6.728
15	.955	.935	38	2.419	2.399	61	3.883	3.863	84	5.348	5.328	107	6.812	6.792
16	1.019	.999	39	2.483	2.463	62	3.947	3.927	85	5.411	5.391	108	6.875	6.855
17	1.082	1.062	40	2.546	2.526	63	4.011	3.991	86	5.475	5.455	109	6.939	6.919
18	1.146	1.126	41	2.610	2.590	64	4.074	4.054	87	5.539	5.519	110	7.003	6.983
19	1.210	1.190	42	2.674	2.654	65	4.138	4.118	88	5.602	5.582	111	7.066	7.046
20	1.273	1.253	43	2.737	2.717	66	4.202	4.182	89	5.666	5.646	112	7.130	7.110
21	1.337	1.317	44	2.801	2.781	67	4.265	4.245	90	5.730	5.710	113	7.194	7.174
22	1.401	1.381	45	2.865	2.845	68	4.329	4.309	91	5.793	5.773	114	7.257	7.237
23	1.464	1.444	46	2.928	2.908	69	4.393	4.373	92	5.857	5.837	115	7.321	7.301
24	1.528	1.508	47	2.992	2.972	70	4.456	4.436	93	5.921	5.901	116	7.385	7.365
25	1.592	1.572	48	3.056	3.036	71	4.520	4.500	94	5.984	5.964	117	7.448	7.428
26	1.655	1.635	49	3.119	3.099	72	4.584	4.564	95	6.048	6.028	118	7.512	7.492
27	1.719	1.699	50	3.183	3.163	73	4.647	4.627	96	6.112	6.092	119	7.576	7.556
28	1.783	1.763	51	3.247	3.227	74	4.711	4.691	97	6.175	6.155	120	7.639	7.619
29	1.846	1.826	52	3.310	3.290	75	4.775	4.755	98	6.239	6.219			
30	1.910	1.890	53	3.474	3.354	76	4.838	4.818	99	6.303	6.283			
31	1.974	1.954	54	3.438	3.418	77	4.902	4.882	100	6.366	6.346			
32	2.037	2.017	55	3.501	3.481	78	4.966	4.946	101	6.430	6.410			

NOTE: See Page 77 for sprocket O.D. tolerances.

# Synchronous Belt Drives – Sprocket Specifications

## Sprocket Specifications — continued

### B. General Tolerances

Gates sprockets are precision made to close tolerances for the best possible performance. Sprockets and bar stock included in this catalog are intended to be used primarily for prototype work. Gates can supply made to order sprockets in a wide range of materials. Gates Product Application Engineering is able to assist in sprocket design. General tolerances are included in the following tables to assist the designer.

**Table 18 – Sprocket O.D. Tolerances**

Sprocket O.D.		Sprocket OD. Tolerances	
(in)	(mm)	(in)	(mm)
Up to 1.000	25.4	+0.02–.000	+0.05–.00
Over 1.000 To 2.000	25.4 50.8	+0.03–.000	+0.08–.00
Over 2.000 To 4.000	50.8 101.6	+0.04–.000	+0.10–.00
Over 4.000 To 7.000	101.6 177.8	+0.05–.000	+0.13–.00
Over 7.000 To 12.000	177.8 304.8	+0.06–.000	+0.15–.00
Over 12.000 To 20.000	304.8 508.0	+0.07–.000	+0.18–.00
Over 20.000	508.0	+0.08–.000	+0.20–.00

**Eccentricity:** The allowable amount of radial runout from the sprocket bore to the O.D. is shown in Table 19.

**Table 19 – Sprocket Run Out**

Outside Diameter		Total Run Out Total Indicator Reading	
(in)	(mm)	(in)	(mm)
Up to 2	50	0.0025	0.06
Over 2 To 4	50 100	0.003	0.08
Over 4 To 8	100 200	0.004	0.10
Over 8	200	0.005	0.13
		+0.0005" per inch O.D. over 8"	+0.0005mm per mm O.D. over 203 mm
(may not exceed face width diameter tolerance)			

**Table 20 – Bore Tolerance for MPB Sprockets**

Bore		Bore Tolerance	
(in)	(mm)	(in)	(mm)
Up to 1.000	25.4	+0.010 – .000	+0.25 – .000
Over 1.000 To 2.000	25.4 50.8	+0.015 – .000	+0.38 – .000

**Pitch Accuracy:** Adequate pitch to pitch accuracy (center of one groove to center of adjacent groove) is generally more difficult to achieve with molded sprockets than with machined sprockets. Recommended tolerances are listed in Table 21.

**Table 21 – Sprocket Pitch Accuracy**

Pulley O.D.		Pitch to Pitch Variation		Accumulative over 90°	
(mm)	(in)	(in)	(mm)	(in)	(mm)
Up to 25.40	1.000	±.001	±0.025	±.0025	±0.064
Over 25.40 To 50.80	1.000 2.000	±.001	±0.025	±.0035	±0.081
Over 50.80 To 101.60	2.000 4.000	±.001	±0.025	±.0045	±0.114
Over 101.60 To 177.80	4.000 7.000	±.001	±0.025	±.0050	±0.127
Over 177.80 To 304.80	7.000 12.000	±.001	±0.025	±.0060	±0.152
Over 304.80 To 508.00	12.000 20.000	±.001	±0.025	±.0065	±0.165
Over 508.00	20.000	±.001	±0.025	±.0075	±0.191

**Helix Angle:** Grooves should be parallel to the axis of the bore within 0.001 (0.025mm) per inch (25.4mm) of sprocket groove face width.

**Draft:** The maximum permissible draft on the groove form is 0.001 (0.025mm) per inch (25.4mm) of face width and must not exceed the O.D. tolerance.

**Parallelism:** The bore of the sprocket is to be perpendicular to the vertical faces of the sprocket within 0.001 (0.025mm) per inch (25.4mm) of diameter with a maximum of 0.020 (0.51mm) total indicator reading.

**Balancing:** Balancing is often not required on machined metal sprockets. All sprockets should be statically balanced to 1/8 oz. (3.5 grams) in all sizes. Drives exceeding 6500 ft./min. (33 m/s) may require special materials, and should be dynamically balanced to 1/4 oz-in. (1.78 newton millimeters)

Production sprockets should be produced as closely to these tolerances as possible to maximize drive performance.

# Synchronous Belt Drives – Sprocket Specifications

## Sprocket Specifications — continued

### C. Groove Specifications

Accurate reproduction of the correct sprocket groove profile in production sprockets is essential in obtaining the full performance capabilities of the drive system. The correct groove profile for a sprocket changes as the number of grooves changes. Gates can assist the designer with sprocket groove profile data. Data can be furnished in the following forms:

**Master Profile:** A scaled line drawing of the ideal groove profile with tolerance bands plotted on dimensionally stable translucent material. Suitable for groove inspection purposes on an optical comparitor.

**Dimensioned Profile Drawing:** A line drawing of the ideal groove profile with all arcs and radii defined. Suitable for mold design.

**Digitized Points:** A series of X and Y coordinates defining the ideal groove profile. Available in printed form or in a data file. Suitable for mold design.

Some sprocket groove profile data is proprietary and can be furnished only to Gates licensees. Check with Gates Product Application Engineering for availability.

**Tolerancing/Inspection Procedure:** A typical sprocket groove tolerance band is illustrated in Fig. 13. Groove inspections must be made on an optical comparitor at a specified magnification. The actual sprocket groove profile must fit within the specified tolerance bands without any sharp transitions or under cuts.

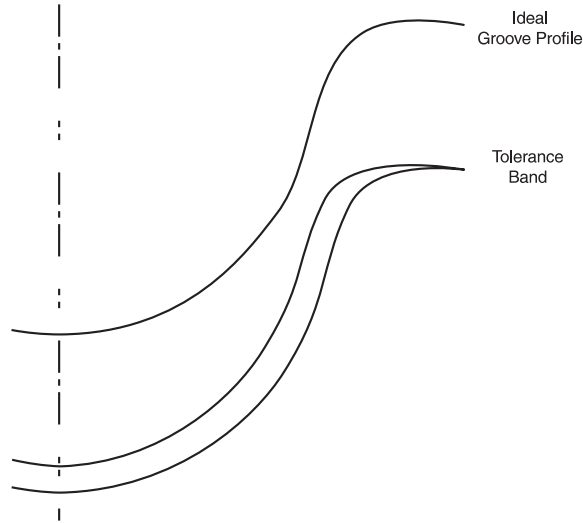
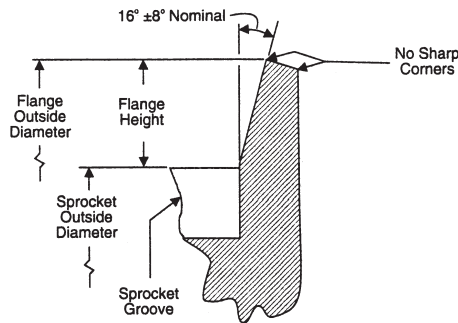

Figure 13

### D. Flange Design and Face Width Guidelines

#### Flanging Guidelines



#### Face Width Guidelines

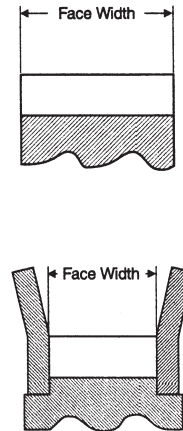

Table 22

Nominal Flange Dimensions for Molding, Sintering, Casting, etc.

Belt Section	Minimum Flange Height		Nominal Flange Height	
	(in)	(mm)	(in)	(mm)
MXL	0.040	—	0.050	—
XL	0.060	—	0.080	—
2MGT	0.043	1.10	0.059	1.50
3M&3MGT	0.067	1.70	0.098	2.50
5M&5MGT	0.091	2.30	0.150	3.80

Table 23

Additional amount of Face Width recommended over Nominal Belt Width (Add Table Values to Nominal Belt Width for Nominal Face Width)

Belt Section	Nominal Face Width Unflanged		Nominal Face Width Flanged	
	(in)	(mm)	(in)	(mm)
MXL	+0.125	—	+0.040	—
XL	+0.190	—	+0.060	—
2MGT	+0.118	+3.00	+0.039	+1.00
3M&3MGT	+0.157	+4.00	+0.049	+1.25
5M&5MGT	+0.197	+5.00	+0.059	+1.50

# Synchronous Belt Drives – Sprocket Specifications

## Sprocket Materials

There are a wide variety of materials and manufacturing processes available for the manufacture of synchronous belt sprockets. In selecting an appropriate material and production process, the designer should consider dimensional accuracy, material strength, durability and production quantity. Some broad guidelines and recommendations are as follows:

### A. Machining:

Excellent dimensional accuracy. Economical for low to moderate production quantities.

#### Typical Materials:

**Steel** – Excellent Wear Resistance

**Aluminum** – Good Wear Resistance; sprockets for power transmission drives should be hard anodized

### B. Powdered Metal And Die Casting:

Good dimensional accuracy. Economical for moderate to high production quantities.

#### Typical Materials:

**Sintered Iron** – Excellent Wear Resistance

**Sintered Aluminum** – Good Wear Resistance; Light Weight and Corrosion Resistant

**Zinc Die Cast** – Good Wear Resistance

**Note:** For non-standard sprocket designs, contact Gates Made-To-Order Metals Team at (800)709-6001.

### C. Plastic Molding:

Good dimensional accuracy. Economical for high production quantities. Best suited for light to moderate torque loads. Fiber loading improves overall material strength and dimensional stability. However, increased belt wear can result from the presence of sharp abrasive fiber ends on the finished surfaces.

Assistance with total drive system design is available. Contact Gates Product Application Engineering for assistance with sprocket design, material selection, manufacturing and sourcing, etc.

# Polyflex® JB® Belt Drives

For information on additional Polyflex JB cross sections, see the Heavy Duty Drive Design Manual 14995-A.

An innovative product developed by Gates, Polyflex JB Belts provide more load-carrying capacity at higher speeds on precision applications than any other V-belt drive. "High power density" puts more power in small spaces.

- Unique construction and 60° angle combine to make Polyflex JB the highest capacity V-belt drive available on comparable diameters
- High modulus, high coefficient of friction polyurethane compound resists fatigue, wear, ozone and most environmental conditions.
- Superior adhesion of tensile cords and specially compounded polyurethane for high fatigue resistance and long belt life
- Precision cast and ground profile for dimensional accuracy and extremely smooth operation
- 60° angle provides greater undercord support to the tensile cord and distributes the load more evenly
- Small mass and large power capacity make Polyflex JB ideal for high speed drives
- Individual belts are joined for greater stability
- Ribbed construction to relieve bending stress on small sheaves and provide lateral rigidity

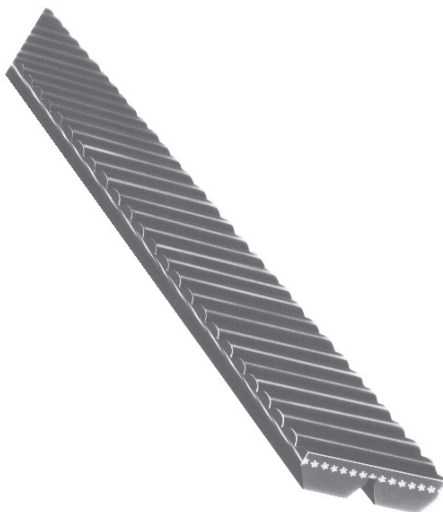

## Polyflex JB Belts

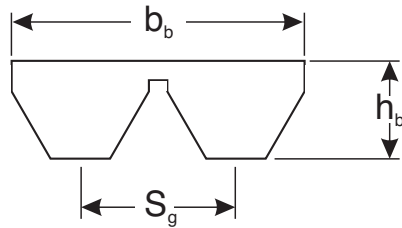

Figure 14

Table 24 — 3M & 5M Polyflex JB Reference Dimensions

Cross Section	Nominal Strand Spacing ( $S_g$ )		Nominal Belt Width ( $b_b$ )		Nominal Thickness ( $h_b$ )	
	(mm)	(in)	(mm)	(in)	(mm)	(in)
<b>3M</b>						
<b>2 Belt Strands</b>	3.3	0.13	6.4	0.25	2.3	0.09
<b>3 Belt Strands</b>	3.3	0.13	9.7	0.38	2.3	0.09
<b>5M</b>						
<b>2 Belt Strands</b>	5.3	0.21	9.9	0.39	3.30	0.13
<b>3 Belt Strands</b>	5.3	0.21	15.2	0.60	3.30	0.13

### Standard Belt Nomenclature

The Polyflex JB Belt is designated by a four-part symbol consisting of: (1) the number of belt strands; (2) the cross section; (3) the effective belt length, and (4) the JB or joined band belt construction.

For example, the belt designation 3/5M1000JB represents:

1. A belt consisting of 3 individual belt strands joined together
2. A 5mm top width for each belt strand
3. An effective length of 1000 mm
4. A Joined Band (JB) belt construction

## Polyurethane Construction

Gates Polyflex JB V-belts are manufactured using specially formulated polyurethane compounds which have a higher coefficient of friction than rubber compounds. Because of the higher coefficient of friction, less wedging action between the belt and the sheave is required. This increased tractive action permits the sheave angle to be increased. The benefits of this feature are discussed in the 60° Angle section on the next page.

Polyurethane has excellent abrasion resistance. As the sheave and belt wear, the belt seats deeper into the sheave groove, contributing to tension decay. This high abrasion resistance feature can mean less frequent belt retensioning. Additional information on abrasion resistance and drives operating in hostile surroundings is provided in the 60° Angle section below and section E. Operating Environments on Page 92.

Polyflex JB belts provide excellent resistance to many chemicals, including some acids and petroleum distillates. However, any chemical or liquid can reduce the coefficient of friction, resulting in excessive belt slipping. Liquids act as lubricants that "grease" the belt, reducing the friction needed for power transmission. Do not use Polyflex JB belts in an environment where the belt is submerged or where liquid in any form can get into the drive.



## Polyurethane Construction - Continued

If the Polyflex JB belt drive is exposed to liquids that can reduce the coefficient of friction, the drive should be completely enclosed or shielded to prevent slipping problems.

Polyurethane also has a much higher compression modulus (i.e., ability to withstand high compressive forces), which permits it to effectively support the tensile cord even when the amount of material is reduced. This allows use of the 60° angle which has 30% less material in the bottom (or compression) part of the belt, compared to a conventional 36° angle belt of the same top width. See Fig. 15.

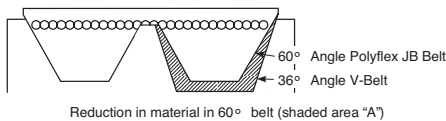

**Figure 15 - 36° and 60° Systems**

### Benefits of 60° Design Angle

Fig. 16 shows the 60° angle sheave groove provides more support to the tensile cord than the 36° angle sheave groove. This additional undercord support reduces differential tensile cord tension caused when the center tensile cords relax due to the belt collapsing under heavy loading. Differential tensile cord tension means that the cords located at the belt edge have a higher tension than the cords in the belt center, as illustrated in Fig. 17. Tension variation reduces belt performance and horsepower capacity, since all the tensile cords do not share the applied load equally. Therefore, the 60° Polyflex JB system permits overall higher horsepower load carrying capability.

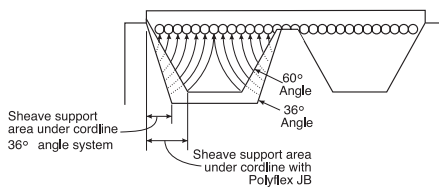

**Figure 16 – Increase in cordline support in 60° sheave**

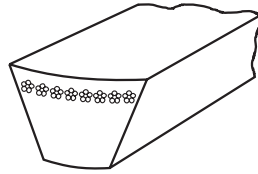

**Figure 17 – Differential tensile cord tension**

The reduced cross-sectional area and lighter polyurethane material combine together to help reduce both bending and centrifugal tension. Bending and centrifugal tension decrease the allowable working tension. Since bending and centrifugal tension are lower for Polyflex JB belts, more effective tension is available for useful work, resulting in higher horsepower ratings.

Initial reduction of operating tension in a V-belt is the result of the belt seating in the sheave groove while operating under a load. The belt effectively runs on a smaller diameter because of seating in and results in a tension loss that requires belt takeup or retensioning. With the 60° Polyflex JB system, longer running time is possible before takeup is required.

The amount a V-belt can seat in the sheave and lose operating tension depends on these factors:

- (1) Abrasion resistance of the belt.
- (2) Abrasive effect of dust or dirt on the sheave groove sidewall.
- (3) Compression modulus (permanent compression set, a stress/time phenomenon, causes tension decay).

Items (1) and (3) above were discussed in the first part of this section under the Polyurethane heading. To briefly review, a high abrasion-resistant material in the belt and a high compression modulus mean less belt tension deterioration.

However, if some belt and sheave wear does occur, the effect on seating in the groove is less for the 60° angle compared to the 36° angle. Any seating due to wear is only 2/3 as great in the Polyflex JB 60° angle as the same wear in a conventional 36° sheave angle. This is illustrated in Fig. 18.

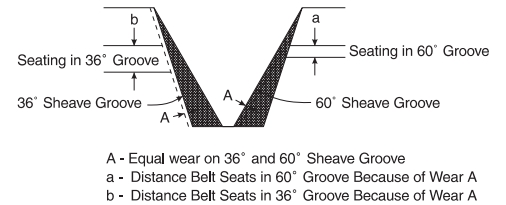

**Figure 18 – Seating in 60° and 36° Sheave Grooves**

In summary, three characteristics of the Polyflex JB belt in the 60° angle sheave -- abrasion resistance, high compression modulus and less movement in the sheave groove (if wear does occur) -- all mean less tension decay. For a Polyflex JB drive, the result is a reduced frequency of retensioning.

## Advantages of Joined Construction

The actual size of a Polyflex JB belt is relatively small when compared to a conventional V-belt. Small belts, just by their nature, have a slightly lower torsional and lateral rigidity. Subsequently, there is a possibility of turning over (Fig. 19) when subjected to a misalignment, power surge or vibrations at or near its natural frequency. To prevent such stability problems, the belt is constructed with the overcord connected or "joined" together as shown in Fig. 20. Joining the strands limits the possibility of a belt turning over on properly maintained drives when subjected to various types of load fluctuations and vibrations. The ribbed overcord of the belt also helps increase torsional and lateral rigidity and increases belt flexibility.

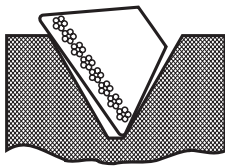

Figure 19 — Turned Over Belt

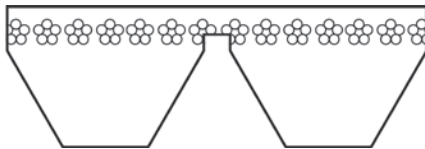

Figure 20 – Polyflex JB

Polyflex JB belts are manufactured with either two, three, four or five belt strands joined together. Any combination of Polyflex JB belts can be used on a single drive in matched sets. For example, if six belts are needed to transmit a load, matched sets of two joined belts with three strands in each belt would work as well as matched sets of three belts with two strands in each belt (see Fig. 21).

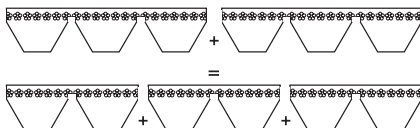

Figure 21 - Joined Belt Combinations

## Matched Sets

When a Polyflex JB drive requires more than 5 strands, matched sets of belts must be used. A matched set of Polyflex JB belts is factory measured and tied together. The belts are measured and grouped within various length ranges. On multiple belt drives (more than 5 strands) this assures that each belt shares its proportion of the load being transmitted. Contact Gates Customer Service for availability.

## Standard Polyflex JB Belt Lengths

Below are the standard belt lengths, with each belt length available in both two, three, four or five strands.

Any combination of Polyflex JB belts can be used on a single drive in matched sets. For example, if six belts are needed to transmit a load, matched sets of two joined belts with three strands in each belt would work as well as matched sets of three belts with two strands in each belt (see Fig. 21).

Table 25 — Standard Polyflex JB Belt Lengths 3M and 5M

*Designation	Effective Length		*Designation	Effective Length	
	(mm)	(in)		(mm)	(in)
3M175JB	171.2	6.74	5M280JB	280	11.02
3M180JB	176.3	6.94	5M290JB	290	11.42
3M185JB	181.1	7.13	5M300JB	300	11.81
3M190JB	186.2	7.33	5M307JB	307	12.09
3M195JB	191.3	7.53	5M315JB	315	12.40
3M200JB	196.1	7.72	5M325JB	325	12.80
3M206JB	202.2	7.96	5M335JB	335	13.19
3M212JB	208.3	8.20	5M345JB	345	13.58
3M218JB	214.1	8.43	5M355JB	355	13.98
3M224JB	220.2	8.67	5M365JB	365	14.37
3M230JB	226.3	8.91	5M375JB	375	14.76
3M236JB	232.2	9.14	5M387JB	387	15.24
3M243JB	239.3	9.42	5M400JB	400	15.75
3M250JB	246.1	9.69	5M412JB	412	16.22
3M258JB	254.3	10.01	5M425JB	425	16.73
3M265JB	261.1	10.28	5M437JB	437	17.21
3M272JB	268.2	10.56	5M450JB	450	17.72
3M280JB	276.1	10.87	5M462JB	462	18.19
3M290JB	286.3	11.27	5M475JB	475	18.70
3M300JB	296.2	11.66	5M487JB	487	19.17
3M307JB	303.3	11.94	5M500JB	500	19.69
3M315JB	311.2	12.25	5M515JB	515	20.28
3M325JB	321.3	12.65	5M530JB	530	20.87
3M335JB	331.2	13.04	5M545JB	545	21.46
3M345JB	341.1	13.43	5M560JB	560	22.05
3M350JB	346.2	13.63	5M580JB	580	22.84
3M355JB	351.3	13.83	5M600JB	600	23.62
3M365JB	361.2	14.22	5M615JB	615	24.21
3M375JB	371.1	14.61	5M630JB	630	24.80
3M387JB	383.3	15.09	5M650JB	650	25.59
3M400JB	396.2	15.60	5M670JB	670	26.38
3M412JB	408.2	16.07	5M690JB	690	27.17
3M425JB	421.1	16.58	5M710JB	710	27.95
3M437JB	433.3	17.06	5M730JB	730	28.74
3M450JB	446.3	17.57	5M750JB	750	29.53
3M462JB	458.2	18.04	5M775JB	775	30.51
3M475JB	471.2	18.55	5M800JB	800	31.50
3M487JB	483.1	19.02	5M825JB	825	32.48
3M500JB	496.3	19.54	5M850JB	850	33.47
3M515JB	511.3	20.13	5M875JB	875	34.45
3M530JB	526.3	20.72	5M900JB	900	35.43
3M545JB	541.3	21.31	5M925JB	925	36.42
3M560JB	556.3	21.90	5M950JB	950	37.40
3M580JB	576.3	22.69	5M975JB	975	38.39
3M600JB	596.1	23.47	5M1000JB	1000	39.37
3M615JB	611.1	24.06	5M1030JB	1030	40.55
3M630JB	626.1	24.65	5M1060JB	1060	41.73
3M650JB	646.2	25.44	5M1090JB	1090	42.91
3M670JB	666.2	26.23	5M1120JB	1120	44.09
3M690JB	660.9	26.02	5M1150JB	1150	45.28
3M710JB	706.1	27.80	5M1180JB	1180	46.46
3M730JB	726.2	28.59	5M1220JB	1220	48.03
3M750JB	746.3	29.38	5M1250JB	1250	49.21
			5M1280JB	1280	50.39
			5M1320JB	1320	51.97
			5M1360JB	1360	53.54
			5M1400JB	1400	55.12
			5M1450JB	1450	57.09
			5M1500JB	1500	59.06

\*Designation No. may not necessarily agree with actual Effective Length.

# Micro-V® Belt Drives

For information on additional Micro-V cross sections, see the *Heavy Duty V-Belt Drive Design Manual 19995-A*.

Gates Micro-V Belts are superior to other V-ribbed belts. The reason is the shorter truncated V-rib design coupled with its premium construction.

The truncated rib profile adds these performance qualities:

- Crack resistant ribs
- Higher load-carrying capacity
- Reduced flex fatigue
- Increased performance on small diameter sheaves allows smaller design packages
- Cool running
- Greater tolerance to sheave groove debris
- Improved resistance to back bending from tensioning idlers

Gates Micro-V Belts offer 80% higher horsepower capacity than ARPM standards. Extra load-carrying capacity means extra long life.

No other V-ribbed belts are built as well as Micro-V Belts, and the Gates belts provide you with the long and improved service life required in the industry today.

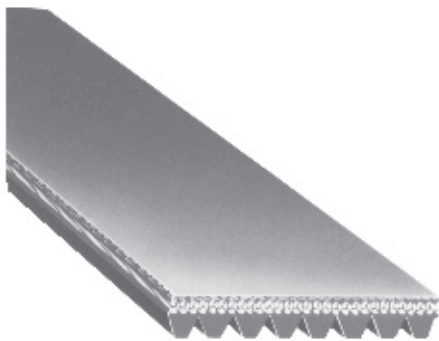

## Micro-V® Belts

### Construction

Gates Micro-V belts feature a smooth-running nylon cross-cord overcord and high modulus, low-stretch polyester tensile cord for added strength and dependability. An optional aramid tensile cord is available on a made-to-order basis.

A specially formulated polychloroprene rubber compound resists oil, heat and cracking. Micro-V belts are static dissipating for added safety.

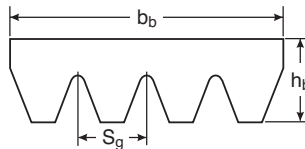

Nominal Top Width,  $b_b = N_r \times S_g$

Where:  $N_r$  = Number of ribs,  
 $S_g$  = Pulley groove spacing

Figure 22 – Micro-V Cross Section

Table 29 – Reference Standard Micro-V Dimensions

Cross Section	Nominal Rib Width ( $S_g$ ) (in)	Nominal Thickness ( $h_b$ ) (in)
H	0.063	0.100
J	0.092	0.128
K	0.140	0.209

### Standard Belt Nomenclature

The Micro-V Belt is correctly identified by a three-part symbol consisting of: (1) a standard length designation; (2) cross section, and (3) number of ribs.

For example: The belt designation “420J6” represents:

1. An effective length of 42.0 inches
2. J Cross Section
3. 6 ribs wide.

### Cross Sections

Light Duty Industrial Micro-V Belts are available from stock in a J Cross Section. H and K Cross Sections are available on a made-to-order basis. Fig. 22 shows a cross-sectional view and illustrates the nominal belt dimensions – rib width and belt thickness – for H, J and K cross sections. These belts will operate in pulleys that are manufactured to the ARPM standard for the specific cross section.

## Standard Micro-V Belt Lengths and Widths

Stock belts are defined by the number of ribs and belt effective lengths specified in Tables 30 and 31, respectively. The line of stock belts available in this manual were chosen specifically to cover the widest possible range of applications.

**Table 31 – Standard Belt Effective Lengths – J Cross Section**

Standard Length Designation	Effective Length (in)	Permissible Deviation From Standard Length (in)	Standard Length Designation	Effective Length (in)	Permissible Deviation From Standard Length (in)
180*	18.0	+0.2 -0.2	420	42.0	+0.2-0.4
190*	19.0	+0.2 -0.2	430	43.0	+0.2 -0.4
200*	20.0	+0.2 -0.2	440	44.0	+0.2 -0.4
220	22.0	+0.2 -0.2	460	46.0	+0.2 -0.4
230	23.0	+0.2 -0.2	480	48.0	+0.2 -0.4
240	24.0	+0.2 -0.2	490	49.0	+0.2 -0.4
260	26.0	+0.2 -0.2	500	50.0	+0.2 -0.4
280	28.0	+0.2 -0.2	520	52.0	+0.2 -0.4
290	29.0	+0.2 -0.3	550	55.0	+0.2 -0.4
300	30.0	+0.2 -0.3	580	58.0	+0.2 -0.5
320	32.0	+0.2 -0.3	610	61.0	+0.2 -0.5
330	33.0	+0.2 -0.3	650	65.0	+0.2 -0.5
340	34.0	+0.2 -0.3	730	73.0	+0.3 -0.6
360	36.0	+0.2 -0.3	870	87.0	+0.3 -0.7
380	38.0	+0.2 -0.3	920**	92.0	+0.4 -0.7
400	40.0	+0.2 -0.4	980**	98.0	+0.4 -0.8
410	41.0	+0.2 -0.4			

\*Available in 4 or 6 rib combinations only.

\*\*Available up to 10 ribs only.

**Table 30 – Stock Rib Widths – J Cross Section**

No. Ribs (b <sub>p</sub> )	Nom. Width (in)	No. Ribs (b <sub>p</sub> )	Nom. Width (in)
4	0.368	16	1.472
6	0.552	20	1.840
10	0.920		

## How to Design Polyflex JB and Micro-V Belt Drives

*Note: The upcoming drive selection and engineering sections provide information for Polyflex JB and Micro-V belts and sheaves (or pulleys). Where we refer to sheaves (for Polyflex JB belts), you can substitute pulleys for Micro-V belts. If you need additional information, contact Gates Product Application Engineering, Denver.*

This section describes how to design standard two-sheave Polyflex JB and Micro-V drives.

To select either a Gates Polyflex JB and Micro-V Belt drive, you need to know these five facts:

1. Horsepower or kilowatt rating of the driveR machine
2. rpm of the driveR machine
3. rpm of the driveN machine
4. Approximate center distance required
5. Hours per day operation.

### Follow these seven steps to design a drive:

#### Step 1 Find the Design Horsepower (Design kw)

Design Horsepower =

(Service Factor) x (Horsepower Requirement)

- A.** Select the proper service factor from Table 37 on Page 87. If your driveN machine is not listed, find a machine with comparable starting, running and shock load characteristics.
- B.** The horsepower requirement of the drive usually is taken as the nameplate rating of the driveR. The actual requirement of the driveN machine may be used as the horsepower requirement, if it is known. This type of load approximation is used in those applications where a small auxiliary machine is being driven from a large motor or engine.

#### Step 2 Find the Speed Ratio

Use Formula 7 on this page to calculate the desired speed ratio for your drive. The speed ratio can be determined from either the shaft speeds or the sheave pitch diameters. To determine the pitch diameter of a sheave, measure the outside diameter and add the appropriate add-on factor from Table 33.

#### Formula 7

$$\text{Speed Ratio} = \frac{\text{RPM of Faster Shaft}}{\text{RPM of Slower Shaft}} = \frac{\text{Pitch Dia. of Larger Sheave}}{\text{Pitch Dia. of Smaller Sheave}}$$

#### Step 3 Choose the Sheave Diameters

- A.** The drive can be designed around a known sheave diameter. For example, if you have one sheave available, or if a minimum or maximum sheave diameter is known, use Formula 7 to determine the other sheave diameter. To calculate the pitch diameter of the larger sheave, multiply the pitch diameter of the smaller sheave by the speed ratio, or divide the pitch diameter of the smaller sheave. To convert the pitch diameter to outside diameters, subtract the values in Table 33 from the pitch diameters.

**Table 33 – Factors to Calculate Polyflex JB and Micro-V Pitch Diameters**

Cross Section	O.D. to P.D. Value	
	(in)	(mm)
3M Polyflex JB	+0.023	+0.58
5M Polyflex JB	+0.050	+1.27
J Micro-V	+0.030	+0.76

**NOTE:** Pitch diameters are always used in speed ratio calculations. If your drive uses an electric motor, the minimum selected sheave O.D. should be at least as large as the sheave outside diameters specified in Table 38 on Page 87.

- B.** Calculate the sheave rim speed for your drive using Formula 8 below:

#### Formula 8

$$\text{Sheave Rim Speed (ft/min)} = \frac{(\text{O.D. of either sheave}) \times (\text{rpm of same sheave})}{3.82^*}$$

\*This constant is derived from 12/π.

Polyflex JB and Micro-V sheaves made with standard materials should not exceed 6,500 feet per minute. If the rim speeds exceed this figure, special sheave materials and dynamic balancing are usually required. If possible, redesign the drive using smaller diameter sheaves so that the rim speed is between 4,000 and 6,000 fpm.

- C.** When designing a drive with larger diameter sheaves consider these factors:

#### Cost Considerations:

Since sheave diameter and rated horsepower per belt or rib are proportional, larger diameter drives will usually require fewer belts or ribs to transmit a specific load. This generally results in a more cost effective drive.

#### Space Limitations:

In addition to being more cost effective, large diameter sheaves will result in a “narrower” drive. Therefore, to minimize the sheave face width, select the largest diameter drive from the group of drives being considered.

However, if there are space restrictions and larger diameter sheaves cannot be used, consider using a smaller diameter drive from the group of drives being considered. If the driveR is an electric motor, the smallest sheave must be at least as large as the Minimum Recommended Sheave O.D. specified in Table 38 on Page 87.

#### Component Life:

As sheave diameters are increased, the required drive tensions and shaft pulls are decreased. By lowering the forces on the bearings, belts and sheaves, component wear is reduced and component service life is extended.

**NOTE:** On some lightly-loaded drives, the cost of the larger sheave (to obtain belt speed between 4,000 and 6,000 feet per minute) may result in a less economical drive. For high horsepower drives, it is usually best to check several designs for economics before making a final choice.

- D.** If the drive requires an idler, refer to Table 43 on Page 96 for recommended idler diameters.

# Polyflex® JB® and Micro-V® Belt Drive Selection Procedures

## How to Design Polyflex JB and Micro-V Belt Drives – Continued

### Step 4 Determine the Belt Length Designation and Actual Center Distance

A. For a two-sheave drive, calculate the belt effective length from Formula 9. If your drive requires an idler, determine the belt effective length from Engineering Section VII. Design of Drives With Idlers on Page 97.

#### Formula 9

$$\text{Belt Effective Length (in)} = 2CD + 1.57(D + d) + \frac{(D - d)^2}{4CD}$$

Where: d = Small sheave outside diameter, inches  
D = Large sheave outside diameter, inches  
CD = Desired center distance, inches.

Compare the calculated belt effective length from Formula 9 to the standard belt effective lengths given in Table 25 or Table 31 on Pages 82 or 84. Find the closest standard belt effective length in Table 25 or Table 31 and calculate the actual center distance using Formula 10 below.

B. The approximate nominal center distance for the drive can be calculated using the following formula:

#### Formula 10

$$\text{Center Distance} = \frac{K + \sqrt{K^2 - 32(D - d)^2}}{16}$$

$$K = 4EL - 6.28(D + d)$$

Where: d = Small sheave outside diameter, inches  
D = Large sheave outside diameter, inches  
EL = Belt effective length, inches

### Step 5 Calculate the Number of Strands/Ribs Required

A. From the tables on Page 88, 89, or 90 find the basic horsepower rating based on the small sheave diameter and rpm of the faster shaft. Add the 'additional horsepower per strand or rib for speed ratio' from the right of the table to find the rated horsepower per strand or rib. Interpolate if necessary.

B. From Table 34, find the Arc of Contact Correction Factor (G) based on the quantity (D - d)/C. (D and d are large and small sheave outside diameters and C is the actual center distance. All values are in inches.)

C. Based on the belt length and cross section that you selected, determine the Belt Length Correction Factor from Table 35 or Table 36 on this page.

D. From Steps B and C, multiply the Arc of Contact Correction Factor (G) and the Belt Length Correction Factor (K<sub>L</sub>) to get the Horsepower Correction Factor.

E. Multiply the rated horsepower per strand or rib by the Horsepower Correction Factor to obtain the Horsepower Per Strand or Rib.

F. Divide the design horsepower from Step 1 by the horsepower per strand or rib to find the number of strands or ribs required. The answer may be a fraction, so always round to the next larger whole number.

**Table 34 – Arc of Contact Correction Factor**

D-d c	Arc of Contact On Small Sheave (degrees)	Arc Correction Factor (G)	
		Polyflex JB	Micro-V
0.00	180	1.00	1.00
0.10	174	0.99	0.98
0.20	169	0.97	0.97
0.30	163	0.96	0.95
0.40	157	0.94	0.94
0.50	151	0.93	0.92
0.60	145	0.91	0.90
0.70	139	0.89	0.88
0.80	133	0.87	0.85
0.90	127	0.85	0.83
1.00	120	0.82	0.80
1.10	113	0.79	0.77
1.20	106	0.77	0.74
1.30	99	0.73	0.71
1.40	91	0.70	0.67
1.50	83	0.65	0.63

**Table 35 – Polyflex JB Length Correction Factors (K<sub>L</sub>)**

3M Belt Length Designation	3M Belt Length Correction Factor	3M Belt Length Designation	3M Belt Length Correction Factor	5M Belt Length Designation	5M Belt Length Correction Factor	5M Belt Length Designation	5M Belt Length Correction Factor
175	0.82	365	1.08	280	0.83	670	1.09
180	0.83	375	1.09	290	0.84	690	1.10
185	0.84	387	1.10	300	0.85	710	1.10
190	0.85	400	1.11	307	0.86	730	1.11
195	0.86	412	1.12	315	0.87	750	1.12
200	0.87	425	1.13	325	0.88	775	1.13
206	0.88	437	1.14	335	0.89	800	1.14
212	0.89	450	1.15	345	0.89	825	1.15
218	0.90	462	1.16	355	0.90	850	1.16
224	0.91	475	1.17	365	0.91	875	1.17
230	0.92	487	1.18	375	0.92	900	1.17
236	0.93	500	1.19	387	0.93	925	1.18
243	0.94	515	1.20	400	0.94	950	1.19
250	0.95	530	1.21	412	0.95	975	1.20
258	0.96	545	1.22	425	0.96	1000	1.20
265	0.97	560	1.23	437	0.96	1030	1.21
272	0.98	580	1.24	450	0.97	1060	1.22
280	0.99	600	1.25	462	0.98	1090	1.23
290	1.00	615	1.26	475	0.99	1120	1.24
300	1.01	630	1.27	487	1.00	1150	1.25
307	1.02	650	1.28	500	1.00	1180	1.25
315	1.03	670	1.29	515	1.01	1220	1.26
325	1.04	690	1.30	530	1.02	1250	1.27
335	1.05	710	1.31	545	1.03	1280	1.28
345	1.06	730	1.32	560	1.04	1320	1.29
350	1.07	750	1.33	580	1.05	1360	1.29
355	1.07			600	1.06	1400	1.30
				615	1.06	1450	1.31
				630	1.07	1500	1.32
				650	1.08		

**Table 36 – Micro-V Length Correction Factors (K<sub>L</sub>)**

Belt Length Designation	Length Correction Factor	Belt Length Designation	Length Correction Factor	Belt Length Designation	Length Correction Factor
180	0.76	360	0.97	580	1.11
190	0.78	380	0.98	610	1.13
200	0.79	400	1.00	650	1.15
220	0.82	420	1.01	730	1.18
240	0.85	430	1.02	870	1.23
260	0.87	440	1.03	920	1.25
280	0.89	460	1.04	980	1.27
300	0.91	490	1.06		
320	0.93	520	1.08		
340	0.95	550	1.10		



# Polyflex® JB® and Micro-V® Belt Drive Selection Procedures

## How to Design Polyflex JB and Micro-V Belt Drives – Continued

### Step 6 Determine the Minimum Installation and Takeup Allowances

- A. Find the recommended installation and takeup allowance in Engineering, Section V. Installation and Takeup Table 41 or Table 42 on Page 95.
- B. For optimum belt performance, the drive must have sufficient belt installation and takeup allowance. Tables 41 and 42 on Page 95 show

the required center distance movement to provide proper installation and takeup. However, if you have a fixed center drive, it also must have provisions for belt length adjustment. Use of idlers is the most common method to provide belt length adjustment with fixed center drives. See Engineering Section VI: Idler Usage on Page 95 and Section VII. Design of Drives With Idlers on Page 97.

**Table 37 – Gates Polyflex JB and Micro-V Service Factors**

DriveN Machine	DriveR					
	Intermittent Service 3-5 Hours Daily or Seasonal	Normal Service 8-10 Hours Daily	Continuous Service 16-24 Hours Daily	Intermittent Service 3-5 Hours Daily or Seasonal	Normal Service 8-10 Hours Daily	Continuous Service 16-24 Hours Daily
The machines listed below are representative samples only. Select the group listed below whose load characteristics most closely approximate those of the machine being considered.	<b>AC Motors:</b> Normal Torque, Squirrel Cage, Synchronous Split Phase <b>DC Motors:</b> Shunt Wound <b>Engines:</b> Multiple Cylinder Internal Combustion			<b>AC Motors:</b> High Torque, High Slip, Repulsion-Induction, Single Phase, Series Wound, Slip Ring <b>DC Motors:</b> Series Wound, Compound Wound <b>Engines:</b> Single Cylinder Internal Combustion <b>Line Shafts Clutches</b>		
	Agitators for Liquids Blowers and Exhausters Centrifugal Pumps & Compressors Display Equipment Dispensing Equipment Fans up to 10 Horsepower Instrumentation Light Duty conveyors Office Equipment	1.0	1.1	1.2	1.1	1.2
Belt conveyors for Sand, Grain, Etc. Dough Mixers Fans - Over 10 Horsepower Generators Line Shafts Laundry Machinery Machine Tools Punches - Presses - Shears Printing Machinery Positive Displacement Rotary Pumps	1.1	1.2	1.3	1.2	1.3	1.4
Brick Machinery Bucket Elevators Exciters Piston Compressors Conveyors (Drag-Pan-Screw) Piston Pumps Positive Displacement Blowers Textile Machinery	1.2	1.3	1.4	1.4	1.5	1.6
Hoists Rubber Calendars - Extruders – Mills	1.3	1.4	1.5	1.5	1.6	1.8

**Table 38 – Minimum Recommended Sheave Outside Diameters for General Purpose Electric Motors**

Motor Horsepower	Motor rpm (60 Cycle and 50 Cycle Electric Motors)						Motor Horsepower	Motor rpm (60 Cycle and 50 Cycle Electric Motors)					
	575 485*	690 575*	870 725*	1160 950*	1750 1425*	3450 2850*		575 485*	690 575*	870 725*	1160 950*	1750 1425*	3450 2850*
1/2	-	-	2.4	-	-	-	3	4.8	4.1	3.2	3.2	2.6	2.6
3/4	-	-	2.6	2.4	-	-	5	4.8	4.8	4.1	3.2	3.2	2.6
1	3.2	2.7	2.6	2.6	2.4	-	7 1/2	5.6	4.8	4.7	4.1	3.2	3.2
1 1/2	3.2	3.2	2.6	2.6	2.6	2.4	10	6.4	5.6	4.7	4.7	4.1	3.2
2	4.1	3.2	3.2	2.6	2.6	2.6	15	7.3	6.4	5.6	4.7	4.7	4.1

\*These speed values are for 50 Cycle electric motors.

# Polyflex® JB® and Micro-V® Belt Drive Selection Procedures

## Polyflex JB Power Ratings

### 3M Polyflex JB Power Ratings

	Basic Horsepower per Strand for Small Outside Diameter														Additional Horsepower per Strand for Speed Ratio										
	(in) (mm)	0.67 17	0.71 18	0.75 19	0.79 20	0.83 21	0.88 22	0.93 24	0.98 25	1.04 26	1.10 28	1.17 30	1.24 31	1.57 40	1.97 50	1.00 to 1.01	1.02 to 1.03	1.04 to 1.05	1.06 to 1.08	1.09 to 1.11	1.12 to 1.15	1.16 to 1.21	1.22 to 1.29	1.30 to 1.46	1.47 and over
575	0.029	0.036	0.043	0.050	0.056	0.064	0.073	0.082	0.092	0.10	0.11	0.12	0.17	0.24	0.000	0.001	0.001	0.003	0.004	0.004	0.005	0.007	0.007	0.008	
690	0.032	0.040	0.048	0.057	0.065	0.075	0.085	0.094	0.11	0.12	0.13	0.15	0.21	0.28	0.000	0.001	0.002	0.003	0.004	0.005	0.007	0.008	0.009	0.010	
725	0.033	0.042	0.050	0.058	0.067	0.077	0.088	0.098	0.11	0.12	0.14	0.15	0.22	0.29	0.000	0.001	0.002	0.003	0.005	0.006	0.007	0.008	0.009	0.010	
870	0.036	0.046	0.056	0.066	0.076	0.089	0.10	0.11	0.13	0.14	0.16	0.18	0.25	0.34	0.000	0.001	0.003	0.004	0.006	0.007	0.008	0.010	0.011	0.012	
950	0.038	0.049	0.060	0.070	0.081	0.094	0.11	0.12	0.14	0.15	0.17	0.19	0.27	0.37	0.000	0.002	0.003	0.005	0.006	0.008	0.009	0.011	0.012	0.014	
1160	0.041	0.054	0.067	0.080	0.093	0.11	0.12	0.14	0.16	0.18	0.20	0.22	0.32	0.44	0.000	0.002	0.004	0.006	0.007	0.009	0.011	0.013	0.015	0.017	
1425	0.045	0.060	0.076	0.091	0.11	0.13	0.14	0.16	0.19	0.21	0.23	0.26	0.38	0.52	0.000	0.002	0.005	0.007	0.009	0.011	0.014	0.016	0.018	0.020	
1750	0.047	0.066	0.085	0.10	0.12	0.14	0.17	0.19	0.22	0.24	0.27	0.31	0.45	0.62	0.000	0.003	0.006	0.008	0.011	0.014	0.017	0.020	0.022	0.025	
2850			0.11	0.13	0.16	0.20	0.23	0.27	0.31	0.35	0.40	0.44	0.66	0.92	0.000	0.005	0.009	0.014	0.018	0.023	0.027	0.032	0.036	0.041	
3450			0.11	0.15	0.18	0.22	0.26	0.30	0.35	0.40	0.46	0.51	0.77	1.07	0.000	0.005	0.011	0.016	0.022	0.027	0.033	0.038	0.044	0.049	
500	0.027	0.033	0.039	0.045	0.051	0.058	0.066	0.073	0.082	0.091	0.10	0.11	0.16	0.21	0.000	0.001	0.002	0.002	0.003	0.004	0.005	0.006	0.006	0.007	
600	0.030	0.037	0.044	0.051	0.058	0.067	0.076	0.085	0.095	0.11	0.12	0.13	0.18	0.25	0.000	0.001	0.002	0.003	0.004	0.005	0.006	0.007	0.008	0.009	
700	0.032	0.041	0.049	0.057	0.065	0.075	0.085	0.095	0.11	0.12	0.13	0.15	0.21	0.29	0.000	0.001	0.002	0.003	0.004	0.006	0.007	0.008	0.009	0.010	
800	0.035	0.044	0.053	0.063	0.072	0.083	0.095	0.11	0.12	0.13	0.15	0.16	0.24	0.32	0.000	0.001	0.003	0.004	0.005	0.006	0.008	0.009	0.010	0.011	
900	0.037	0.047	0.058	0.068	0.078	0.091	0.10	0.12	0.13	0.15	0.16	0.18	0.26	0.35	0.000	0.001	0.003	0.004	0.006	0.007	0.009	0.010	0.011	0.013	
1000	0.039	0.050	0.061	0.073	0.084	0.098	0.11	0.13	0.14	0.16	0.18	0.20	0.28	0.39	0.000	0.002	0.003	0.005	0.006	0.008	0.010	0.011	0.013	0.014	
1200	0.042	0.055	0.069	0.082	0.095	0.11	0.13	0.14	0.16	0.18	0.20	0.23	0.33	0.45	0.000	0.002	0.004	0.006	0.008	0.010	0.011	0.013	0.015	0.017	
1400	0.044	0.060	0.075	0.090	0.11	0.12	0.14	0.16	0.18	0.21	0.23	0.26	0.37	0.51	0.000	0.002	0.004	0.007	0.009	0.011	0.013	0.016	0.018	0.020	
1600	0.046	0.064	0.081	0.098	0.11	0.14	0.16	0.18	0.20	0.23	0.26	0.28	0.42	0.57	0.000	0.003	0.005	0.008	0.010	0.013	0.015	0.018	0.020	0.023	
1800		0.067	0.086	0.10	0.12	0.15	0.17	0.19	0.22	0.25	0.28	0.31	0.46	0.63	0.000	0.003	0.006	0.009	0.011	0.014	0.017	0.020	0.023	0.026	
2000		0.070	0.091	0.11	0.13	0.16	0.18	0.21	0.24	0.27	0.30	0.34	0.50	0.69	0.000	0.003	0.006	0.010	0.013	0.016	0.019	0.022	0.025	0.029	
3000			0.11	0.14	0.17	0.20	0.24	0.28	0.32	0.36	0.41	0.46	0.69	0.95	0.000	0.005	0.010	0.014	0.019	0.024	0.029	0.033	0.038	0.043	
4000				0.15	0.19	0.24	0.29	0.33	0.39	0.44	0.51	0.57	0.86	1.20	0.000	0.006	0.013	0.019	0.026	0.032	0.038	0.045	0.051	0.057	
5000					0.21	0.27	0.32	0.38	0.45	0.51	0.59	0.67	1.02	1.42	0.000	0.008	0.016	0.024	0.032	0.040	0.048	0.056	0.064	0.072	
6000					0.22	0.29	0.36	0.42	0.50	0.58	0.67	0.76	1.16	1.63	0.000	0.010	0.019	0.029	0.038	0.048	0.057	0.067	0.076	0.086	
7000						0.31	0.38	0.46	0.55	0.63	0.74	0.84	1.29	1.81	0.000	0.011	0.022	0.033	0.045	0.056	0.067	0.078	0.089	0.100	
8000							0.40	0.49	0.59	0.68	0.80	0.91	1.41	1.98	0.000	0.013	0.026	0.038	0.051	0.064	0.076	0.089	0.102	0.115	
9000								0.42	0.51	0.62	0.73	0.85	1.52	2.13	0.000	0.014	0.029	0.043	0.057	0.072	0.086	0.100	0.115	0.129	
10000									0.53	0.65	0.77	0.90	1.03	1.62	2.27	0.000	0.016	0.032	0.048	0.064	0.080	0.096	0.112	0.127	0.143
12000									0.69	0.83	0.98	1.13	1.78	2.48	0.000	0.019	0.038	0.057	0.077	0.096	0.115	0.134	0.153	0.172	
575	0.022	0.027	0.032	0.037	0.042	0.048	0.055	0.061	0.069	0.076	0.085	0.093	0.13	0.18	0.000	0.001	0.001	0.002	0.003	0.003	0.004	0.005	0.005	0.006	
690	0.024	0.030	0.036	0.042	0.048	0.056	0.063	0.070	0.079	0.088	0.098	0.11	0.15	0.21	0.000	0.001	0.002	0.002	0.003	0.004	0.005	0.006	0.007	0.007	
725	0.025	0.031	0.037	0.044	0.050	0.058	0.065	0.073	0.082	0.092	0.10	0.11	0.16	0.22	0.000	0.001	0.002	0.003	0.004	0.005	0.006	0.007	0.008	0.008	
870	0.027	0.035	0.042	0.049	0.057	0.066	0.075	0.084	0.095	0.11	0.12	0.13	0.19	0.26	0.000	0.001	0.002	0.003	0.004	0.005	0.006	0.007	0.008	0.009	
950	0.028	0.036	0.044	0.052	0.060	0.070	0.080	0.090	0.10	0.11	0.13	0.14	0.20	0.28	0.000	0.001	0.002	0.003	0.005	0.006	0.007	0.008	0.009	0.010	
1160	0.031	0.041	0.050	0.060	0.069	0.081	0.093	0.10	0.12	0.13	0.15	0.16	0.24	0.33	0.000	0.001	0.003	0.004	0.006	0.007	0.008	0.010	0.011	0.012	
1425	0.033	0.045	0.057	0.068	0.080	0.094	0.11	0.12	0.14	0.16	0.17	0.19	0.28	0.39	0.000	0.002	0.003	0.005	0.007	0.008	0.010	0.012	0.014	0.015	
1750	0.035	0.049	0.063	0.077	0.091	0.11	0.12	0.14	0.16	0.18	0.20	0.23	0.33	0.46	0.000	0.002	0.004	0.006	0.008	0.010	0.012	0.015	0.017	0.019	
2850			0.079	0.10	0.12	0.15	0.17	0.20	0.23	0.26	0.30	0.33	0.49	0.68	0.000	0.003	0.007	0.010	0.014	0.017	0.020	0.024	0.027	0.030	
3450			0.084	0.11	0.13	0.16	0.20	0.23	0.26	0.30	0.34	0.38	0.57	0.80	0.000	0.004	0.008	0.012	0.016	0.020	0.025	0.029	0.033	0.037	
500	0.020	0.024	0.029	0.033	0.038	0.044	0.049	0.055	0.061	0.068	0.075	0.083	0.12	0.16	0.000	0.001	0.001	0.002	0.002	0.003	0.004	0.004	0.005	0.005	
600	0.022	0.027	0.033	0.038	0.043	0.050	0.057	0.063	0.071	0.079	0.088	0.096	0.14	0.19	0.000	0.001	0.001	0.002	0.003	0.004	0.004	0.005	0.006	0.006	
700	0.024	0.030	0.036	0.043	0.049	0.056	0.064	0.071	0.080	0.089	0.099	0.11	0.16	0.21	0.000	0.001	0.002	0.002	0.003	0.004	0.005	0.006	0.007	0.007	
800	0.026	0.033	0.040	0.047	0.054	0.062	0.071	0.079	0.089	0.099	0.11	0.12	0.18	0.24	0.000	0.001	0.002	0.003	0.004	0.005	0.006	0.007	0.008	0.009	
900	0.027	0.035	0.043	0.051	0.058	0.068	0.077	0.086	0.098	0.11	0.12	0.13	0.19	0.26	0.000	0.001	0.002	0.003	0.004	0.005	0.006	0.007	0.009	0.010	
1000	0.029	0.037	0.046	0.054	0.063	0.073	0.083	0.094	0.11	0.12	0.13	0.15	0.21	0.29	0.000	0.001	0.002	0.004	0.005	0.006	0.007	0.008	0.010	0.011	
1200	0.031	0.041	0.051	0.061	0.071	0.083	0.095	0.11	0.12	0.14	0.15	0.17	0.25	0.34	0.000	0.001	0.003	0.004	0.006	0.007	0.009	0.010	0.011	0.013	
1400	0.033	0.045	0.056	0.067	0.079	0.093	0.11	0.12	0.14	0.15	0.17	0.19	0.28	0.38	0.000	0.002	0.003	0.005	0.007	0.008	0.010	0.012	0.013	0.015	
1600	0.034	0.047	0.060	0.073	0.086	0.10	0.12	0.13	0.15	0.17	0.19	0.21	0.31	0.43	0.000	0.002	0.004	0.006	0.008	0.010	0.011	0.013	0.015	0.017	
1800	</																								

# Polyflex® JB® and Micro-V® Belt Drive Selection Procedures

## Polyflex JB Power Ratings

### 5M Polyflex JB Power Ratings

rpm of Faster Shaft	Basic Horsepower per Strand for Small Outside Diameter												Additional Horsepower per Strand for Speed Ratio										
	(in)	1.04	1.10	1.17	1.24	1.32	1.40	1.48	1.57	1.67	1.77	1.87	1.97	1.00	1.02	1.04	1.06	1.09	1.12	1.16	1.22	1.30	1.47
	mm	26	28	30	32	34	36	38	40	42	45	48	50	to 1.01	to 1.03	to 1.05	to 1.08	to 1.11	to 1.15	to 1.21	to 1.29	to 1.46	and over
575	0.11	0.13	0.15	0.17	0.20	0.23	0.25	0.28	0.32	0.35	0.38	0.41	0.00	0.00	0.01	0.01	0.01	0.01	0.02	0.02	0.02	0.02	0.02
690	0.12	0.14	0.17	0.20	0.23	0.26	0.29	0.33	0.37	0.41	0.44	0.48	0.00	0.00	0.01	0.01	0.01	0.01	0.02	0.02	0.02	0.02	0.03
725	0.12	0.15	0.18	0.21	0.24	0.27	0.31	0.34	0.38	0.42	0.46	0.50	0.00	0.00	0.01	0.01	0.01	0.01	0.02	0.02	0.02	0.03	0.03
870	0.14	0.17	0.20	0.24	0.28	0.32	0.36	0.40	0.45	0.49	0.54	0.59	0.00	0.00	0.01	0.01	0.02	0.02	0.02	0.03	0.03	0.04	0.04
950	0.15	0.18	0.22	0.26	0.30	0.34	0.38	0.43	0.48	0.53	0.58	0.63	0.00	0.00	0.01	0.01	0.02	0.02	0.03	0.03	0.03	0.04	0.04
1160	0.17	0.21	0.25	0.30	0.35	0.40	0.45	0.50	0.57	0.63	0.69	0.75	0.00	0.01	0.01	0.02	0.02	0.03	0.03	0.04	0.04	0.05	0.05
1425	0.19	0.24	0.29	0.35	0.41	0.47	0.53	0.60	0.67	0.74	0.82	0.89	0.00	0.01	0.01	0.02	0.03	0.03	0.04	0.04	0.05	0.05	0.06
1750	0.22	0.27	0.34	0.40	0.47	0.55	0.62	0.70	0.79	0.88	0.97	1.06	0.00	0.01	0.02	0.02	0.03	0.04	0.05	0.06	0.06	0.07	0.07
2850		0.36	0.46	0.56	0.68	0.79	0.90	1.03	1.17	1.31	1.44	1.58	0.00	0.01	0.03	0.04	0.05	0.06	0.08	0.09	0.10	0.12	0.12
3450			0.52	0.64	0.77	0.91	1.04	1.19	1.36	1.52	1.68	1.84	0.00	0.02	0.03	0.05	0.06	0.08	0.09	0.11	0.12	0.14	0.14
500	0.10	0.11	0.13	0.15	0.18	0.20	0.23	0.25	0.28	0.31	0.34	0.37	0.00	0.00	0.00	0.01	0.01	0.01	0.01	0.02	0.02	0.02	0.02
600	0.11	0.13	0.15	0.18	0.21	0.23	0.26	0.29	0.33	0.36	0.39	0.43	0.00	0.00	0.01	0.01	0.01	0.01	0.02	0.02	0.02	0.02	0.02
700	0.12	0.15	0.17	0.20	0.23	0.27	0.30	0.33	0.37	0.41	0.45	0.49	0.00	0.00	0.01	0.01	0.01	0.01	0.02	0.02	0.02	0.03	0.03
800	0.13	0.16	0.19	0.22	0.26	0.30	0.33	0.37	0.42	0.46	0.50	0.55	0.00	0.00	0.01	0.01	0.01	0.01	0.02	0.02	0.03	0.03	0.03
900	0.14	0.17	0.21	0.24	0.29	0.33	0.36	0.41	0.46	0.51	0.56	0.61	0.00	0.00	0.01	0.01	0.02	0.02	0.02	0.03	0.03	0.04	0.04
1000	0.15	0.19	0.23	0.27	0.31	0.35	0.40	0.45	0.50	0.55	0.61	0.66	0.00	0.00	0.01	0.01	0.02	0.02	0.03	0.03	0.04	0.04	0.04
1200	0.17	0.21	0.26	0.30	0.36	0.41	0.46	0.52	0.58	0.65	0.71	0.77	0.00	0.01	0.01	0.02	0.02	0.03	0.03	0.04	0.04	0.05	0.05
1400	0.19	0.23	0.29	0.34	0.40	0.46	0.52	0.59	0.66	0.73	0.81	0.88	0.00	0.01	0.01	0.02	0.03	0.03	0.04	0.04	0.05	0.06	0.06
1600	0.20	0.26	0.32	0.38	0.44	0.51	0.58	0.65	0.74	0.82	0.90	0.98	0.00	0.01	0.01	0.02	0.03	0.04	0.04	0.05	0.06	0.06	0.06
1800	0.22	0.28	0.34	0.41	0.48	0.56	0.63	0.72	0.81	0.90	0.99	1.08	0.00	0.01	0.02	0.02	0.03	0.04	0.05	0.06	0.06	0.07	0.07
2000	0.23	0.29	0.37	0.44	0.52	0.61	0.69	0.78	0.88	0.98	1.08	1.18	0.00	0.01	0.02	0.03	0.04	0.05	0.05	0.06	0.07	0.08	0.08
3000		0.37	0.48	0.58	0.70	0.82	0.94	1.07	1.22	1.36	1.50	1.65	0.00	0.01	0.03	0.04	0.05	0.07	0.08	0.09	0.11	0.12	0.12
4000			0.57	0.70	0.86	1.01	1.16	1.33	1.52	1.70	1.89	2.07	0.00	0.02	0.04	0.05	0.07	0.09	0.11	0.13	0.14	0.16	0.16
5000			0.64	0.80	0.99	1.18	1.36	1.57	1.80	2.02	2.24	2.47	0.00	0.02	0.05	0.07	0.09	0.11	0.14	0.16	0.18	0.20	0.20
6000				0.89	1.11	1.33	1.54	1.78	2.05	2.31	2.57	2.83	0.00	0.03	0.05	0.08	0.11	0.14	0.16	0.19	0.22	0.24	0.24
7000				0.96	1.21	1.46	1.71	1.98	2.28	2.58	2.88	3.17	0.00	0.03	0.06	0.09	0.13	0.16	0.19	0.22	0.25	0.28	0.28
8000					1.30	1.58	1.86	2.16	2.50	2.83	3.16	3.49	0.00	0.04	0.07	0.11	0.14	0.18	0.22	0.25	0.29	0.32	0.32
9000					1.38	1.69	1.99	2.33	2.70	3.06	3.42	3.77	0.00	0.04	0.08	0.12	0.16	0.20	0.24	0.28	0.32	0.36	0.36
10000					1.45	1.78	2.11	2.47	2.87	3.27	3.65	4.04	0.00	0.04	0.09	0.13	0.18	0.23	0.27	0.32	0.36	0.40	0.40
12000					1.93	2.30	2.72	3.17	3.62	4.06	4.48	4.88	0.00	0.05	0.11	0.16	0.22	0.27	0.32	0.38	0.43	0.49	0.49
	Basic Kilowatt per Strand for Small Outside Diameter												Additional Kilowatt per Strand for Speed Ratio										
575	0.07	0.09	0.11	0.13	0.15	0.17	0.19	0.21	0.23	0.26	0.29	0.31	0.00	0.00	0.00	0.01	0.01	0.01	0.01	0.01	0.01	0.02	0.02
690	0.08	0.11	0.13	0.15	0.18	0.20	0.22	0.25	0.27	0.30	0.34	0.36	0.00	0.00	0.00	0.01	0.01	0.01	0.01	0.01	0.02	0.02	0.02
725	0.09	0.11	0.14	0.16	0.18	0.21	0.23	0.26	0.28	0.32	0.35	0.37	0.00	0.00	0.00	0.01	0.01	0.01	0.01	0.02	0.02	0.02	0.02
870	0.10	0.13	0.16	0.19	0.21	0.24	0.27	0.30	0.33	0.37	0.41	0.44	0.00	0.00	0.01	0.01	0.01	0.01	0.02	0.02	0.02	0.03	0.03
950	0.10	0.14	0.17	0.20	0.23	0.26	0.29	0.32	0.35	0.40	0.44	0.47	0.00	0.00	0.01	0.01	0.01	0.02	0.02	0.02	0.03	0.03	0.03
1160	0.12	0.16	0.19	0.23	0.27	0.30	0.34	0.38	0.41	0.47	0.52	0.56	0.00	0.00	0.01	0.01	0.02	0.02	0.02	0.03	0.03	0.04	0.04
1425	0.13	0.18	0.22	0.27	0.31	0.36	0.40	0.45	0.49	0.56	0.62	0.66	0.00	0.00	0.01	0.01	0.02	0.02	0.03	0.03	0.04	0.04	0.04
1750	0.15	0.20	0.26	0.31	0.37	0.42	0.47	0.53	0.58	0.66	0.74	0.79	0.00	0.01	0.01	0.02	0.02	0.03	0.04	0.04	0.05	0.05	0.05
2850		0.27	0.36	0.44	0.52	0.61	0.69	0.77	0.85	0.98	1.10	1.18	0.00	0.01	0.02	0.03	0.04	0.05	0.06	0.07	0.08	0.09	0.09
3450			0.40	0.50	0.60	0.70	0.80	0.89	0.99	1.14	1.28	1.37	0.00	0.01	0.02	0.03	0.05	0.06	0.07	0.08	0.09	0.10	0.10
500	0.07	0.09	0.10	0.12	0.14	0.15	0.17	0.19	0.21	0.23	0.26	0.27	0.00	0.00	0.00	0.01	0.01	0.01	0.01	0.01	0.01	0.01	0.02
600	0.08	0.10	0.12	0.14	0.16	0.18	0.20	0.22	0.24	0.27	0.30	0.32	0.00	0.00	0.00	0.01	0.01	0.01	0.01	0.01	0.01	0.02	0.02
700	0.09	0.11	0.13	0.16	0.18	0.20	0.23	0.25	0.27	0.31	0.34	0.36	0.00	0.00	0.00	0.01	0.01	0.01	0.01	0.01	0.02	0.02	0.02
800	0.09	0.12	0.15	0.17	0.20	0.23	0.25	0.28	0.30	0.34	0.38	0.41	0.00	0.00	0.01	0.01	0.01	0.01	0.02	0.02	0.02	0.02	0.02
900	0.10	0.13	0.16	0.19	0.22	0.25	0.28	0.31	0.34	0.38	0.42	0.45	0.00	0.00	0.01	0.01	0.01	0.01	0.02	0.02	0.02	0.03	0.03
1000	0.11	0.14	0.17	0.21	0.24	0.27	0.30	0.33	0.37	0.41	0.46	0.49	0.00	0.00	0.01	0.01	0.01	0.01	0.02	0.02	0.02	0.03	0.03
1200	0.12	0.16	0.20	0.24	0.27	0.31	0.35	0.39	0.43	0.48	0.54	0.58	0.00	0.00	0.01	0.01	0.02	0.02	0.02	0.03	0.03	0.04	0.04
1400	0.13	0.18	0.22	0.27	0.31	0.35	0.40	0.44	0.48	0.55	0.61	0.65	0.00	0.00	0.01	0.01	0.02	0.02	0.03	0.03	0.04	0.04	0.04
1600	0.14	0.19	0.24	0.29	0.34	0.39	0.44	0.49	0.54	0.61	0.68	0.73	0.00	0.01	0.01	0.02	0.02	0.03	0.03	0.04	0.04	0.05	0.05
1800	0.15	0.21	0.26	0.32	0.37	0.43	0.48	0.54	0.59	0.67	0.75	0.81	0.00	0.01	0.01	0.02	0.02	0.03	0.04	0.04	0.05	0.05	0.05
2000	0.16	0.22	0.28	0.34	0.41	0.47	0.53	0.59	0.65	0.73	0.82	0.88	0.00	0.01	0.01	0.02	0.03	0.03	0.04	0.05	0.05	0.06	0.06
3000		0.28	0.37	0.46	0.54	0.63	0.72	0.80	0.89	1.02	1.14	1.23	0.00	0.01	0.02	0.03	0.04	0.05	0.06	0.07	0.08	0.09	0.09
4000			0.44	0.55	0.66	0.78	0.89	1.00	1.11	1.27	1.44	1.54	0.00	0.01	0.03	0.04	0.05	0.07	0.08	0.09	0.		

# Polyflex® JB® and Micro-V® Belt Drive Selection Procedures

## Micro-V Power Ratings

### J Section Micro-V Power Ratings

rpm of Faster Shaft	Basic Horsepower per Rib for Small Outside Diameter															Additional Horsepower per Rib for Speed Ratio											
	(in)	0.80	0.90	1.00	1.10	1.20	1.30	1.40	1.50	1.60	1.70	1.80	1.90	2.00	2.20	2.40	1.00 to 1.02	1.03 to 1.06	1.07 to 1.10	1.11 to 1.16	1.17 to 1.23	1.24 to 1.33	1.34 to 1.47	1.48 to 1.71	1.72 to 2.31	2.32 and over	
	mm	20.3	22.9	25.4	27.9	30.5	33.0	35.6	38.1	40.6	43.1	45.7	48.3	50.8	55.9	61.0											
575	0.02	0.03	0.03	0.04	0.05	0.06	0.06	0.07	0.08	0.09	0.09	0.10	0.11	0.12	0.14	0.00	0.00	0.00	0.00	0.00	0.00	0.01	0.01	0.01	0.01	0.01	
690	0.02	0.03	0.04	0.05	0.06	0.07	0.07	0.08	0.09	0.10	0.11	0.12	0.13	0.15	0.16	0.00	0.00	0.00	0.00	0.00	0.01	0.01	0.01	0.01	0.01	0.01	
725	0.02	0.03	0.04	0.05	0.06	0.07	0.08	0.09	0.10	0.11	0.12	0.13	0.15	0.17	0.00	0.00	0.00	0.00	0.00	0.01	0.01	0.01	0.01	0.01	0.01	0.01	
870	0.02	0.03	0.05	0.06	0.07	0.08	0.09	0.10	0.11	0.12	0.13	0.15	0.16	0.18	0.20	0.00	0.00	0.00	0.00	0.01	0.01	0.01	0.01	0.01	0.01	0.01	
950	0.02	0.04	0.05	0.06	0.07	0.09	0.10	0.11	0.12	0.13	0.15	0.16	0.17	0.19	0.21	0.00	0.00	0.00	0.00	0.01	0.01	0.01	0.01	0.01	0.01	0.01	
1160	0.03	0.04	0.06	0.07	0.09	0.10	0.12	0.13	0.14	0.16	0.17	0.19	0.20	0.23	0.26	0.00	0.00	0.00	0.01	0.01	0.01	0.01	0.01	0.01	0.01	0.02	
1425	0.03	0.05	0.07	0.08	0.10	0.12	0.14	0.15	0.17	0.19	0.21	0.22	0.24	0.27	0.30	0.00	0.00	0.00	0.01	0.01	0.01	0.01	0.01	0.01	0.02	0.02	
1750	0.03	0.06	0.08	0.10	0.12	0.14	0.16	0.18	0.20	0.22	0.24	0.26	0.28	0.32	0.36	0.00	0.00	0.01	0.01	0.01	0.01	0.01	0.02	0.02	0.02	0.03	
2850	0.04	0.08	0.11	0.14	0.17	0.21	0.24	0.27	0.30	0.33	0.36	0.40	0.43	0.49	0.55	0.00	0.00	0.01	0.01	0.02	0.02	0.03	0.03	0.04	0.04	0.04	
3450	0.04	0.08	0.12	0.16	0.20	0.24	0.28	0.31	0.35	0.39	0.43	0.46	0.50	0.57	0.64	0.00	0.01	0.01	0.02	0.02	0.03	0.03	0.04	0.04	0.05	0.05	
500	0.02	0.02	0.03	0.04	0.04	0.05	0.06	0.06	0.07	0.08	0.08	0.09	0.10	0.11	0.12	0.00	0.00	0.00	0.00	0.00	0.00	0.00	0.01	0.01	0.01	0.01	
600	0.02	0.03	0.03	0.04	0.05	0.06	0.07	0.07	0.08	0.09	0.10	0.11	0.11	0.13	0.14	0.00	0.00	0.00	0.00	0.00	0.00	0.01	0.01	0.01	0.01	0.01	
700	0.02	0.03	0.04	0.05	0.06	0.07	0.08	0.08	0.09	0.10	0.11	0.12	0.13	0.15	0.16	0.00	0.00	0.00	0.00	0.00	0.01	0.01	0.01	0.01	0.01	0.01	
800	0.02	0.03	0.04	0.05	0.06	0.07	0.08	0.09	0.11	0.12	0.13	0.14	0.15	0.17	0.18	0.00	0.00	0.00	0.00	0.01	0.01	0.01	0.01	0.01	0.01	0.01	
900	0.02	0.04	0.05	0.06	0.07	0.08	0.09	0.10	0.12	0.13	0.14	0.15	0.16	0.18	0.20	0.00	0.00	0.00	0.00	0.01	0.01	0.01	0.01	0.01	0.01	0.01	
1000	0.02	0.04	0.05	0.06	0.08	0.09	0.10	0.11	0.13	0.14	0.15	0.16	0.18	0.20	0.22	0.00	0.00	0.00	0.00	0.01	0.01	0.01	0.01	0.01	0.01	0.01	
1200	0.03	0.04	0.06	0.07	0.09	0.10	0.12	0.13	0.15	0.16	0.18	0.19	0.21	0.23	0.26	0.00	0.00	0.00	0.01	0.01	0.01	0.01	0.01	0.01	0.02	0.02	
1400	0.03	0.05	0.07	0.08	0.10	0.12	0.13	0.15	0.17	0.19	0.20	0.22	0.24	0.27	0.30	0.00	0.00	0.00	0.01	0.01	0.01	0.01	0.01	0.02	0.02	0.02	
1600	0.03	0.05	0.07	0.09	0.11	0.13	0.15	0.17	0.19	0.21	0.23	0.24	0.26	0.30	0.34	0.00	0.00	0.01	0.01	0.01	0.01	0.01	0.02	0.02	0.02	0.02	
1800	0.03	0.06	0.08	0.10	0.12	0.14	0.17	0.19	0.21	0.23	0.25	0.27	0.29	0.33	0.37	0.00	0.00	0.01	0.01	0.01	0.01	0.01	0.02	0.02	0.02	0.03	
2000	0.04	0.06	0.09	0.11	0.13	0.16	0.18	0.20	0.23	0.25	0.27	0.30	0.32	0.36	0.41	0.00	0.00	0.01	0.01	0.01	0.02	0.02	0.03	0.03	0.04	0.04	
3000	0.04	0.08	0.11	0.15	0.18	0.22	0.25	0.28	0.32	0.35	0.38	0.41	0.44	0.51	0.57	0.00	0.00	0.01	0.01	0.02	0.02	0.03	0.03	0.04	0.05	0.06	
4000	0.04	0.09	0.13	0.18	0.22	0.27	0.31	0.35	0.40	0.44	0.48	0.52	0.56	0.64	0.72	0.00	0.01	0.01	0.02	0.03	0.03	0.04	0.04	0.05	0.06	0.06	
5000	0.04	0.10	0.15	0.21	0.26	0.31	0.37	0.42	0.47	0.52	0.57	0.62	0.66	0.76	0.85	0.00	0.01	0.02	0.02	0.03	0.04	0.05	0.06	0.06	0.07	0.07	
6000	0.04	0.11	0.17	0.23	0.30	0.36	0.42	0.48	0.53	0.59	0.65	0.70	0.76	0.87	0.97	0.00	0.01	0.02	0.03	0.04	0.05	0.06	0.07	0.08	0.09	0.09	
7000	0.04	0.11	0.18	0.25	0.32	0.39	0.46	0.53	0.59	0.66	0.72	0.78	0.84	0.96	1.07	0.00	0.01	0.02	0.03	0.04	0.06	0.07	0.08	0.09	0.10	0.10	
8000	0.03	0.11	0.19	0.27	0.35	0.43	0.50	0.58	0.65	0.72	0.79	0.85	0.92	1.04	1.16	0.00	0.01	0.03	0.04	0.05	0.06	0.08	0.09	0.10	0.11	0.11	
9000	0.02	0.11	0.20	0.29	0.37	0.46	0.54	0.62	0.69	0.77	0.84	0.91	0.98	1.11	1.23	0.00	0.01	0.03	0.04	0.06	0.07	0.09	0.10	0.11	0.13	0.13	
10000	0.01	0.11	0.21	0.30	0.39	0.48	0.57	0.65	0.73	0.81	0.89	0.96	1.03	1.16	1.28	0.00	0.02	0.03	0.05	0.06	0.08	0.10	0.11	0.13	0.14	0.14	
	Basic Kilowatt per Rib for Small Outside Diameter															Additional Kilowatt per Rib for Speed Ratio											
575	0.01	0.02	0.02	0.03	0.04	0.04	0.05	0.05	0.06	0.06	0.07	0.08	0.08	0.09	0.10	0.00	0.00	0.00	0.00	0.00	0.00	0.00	0.01	0.01	0.01	0.01	
690	0.01	0.02	0.03	0.04	0.04	0.05	0.06	0.06	0.07	0.08	0.08	0.09	0.10	0.11	0.12	0.00	0.00	0.00	0.00	0.00	0.00	0.00	0.01	0.01	0.01	0.01	
725	0.01	0.02	0.03	0.04	0.04	0.05	0.06	0.06	0.07	0.08	0.09	0.09	0.10	0.11	0.13	0.00	0.00	0.00	0.00	0.00	0.00	0.01	0.01	0.01	0.01	0.01	
870	0.02	0.03	0.03	0.04	0.05	0.06	0.07	0.08	0.09	0.09	0.10	0.11	0.12	0.13	0.15	0.00	0.00	0.00	0.00	0.00	0.01	0.01	0.01	0.01	0.01	0.01	
950	0.02	0.03	0.04	0.05	0.05	0.06	0.07	0.08	0.09	0.10	0.11	0.12	0.13	0.14	0.16	0.00	0.00	0.00	0.00	0.00	0.01	0.01	0.01	0.01	0.01	0.01	
1160	0.02	0.03	0.04	0.05	0.06	0.08	0.09	0.10	0.11	0.12	0.13	0.14	0.15	0.17	0.19	0.00	0.00	0.00	0.01	0.01	0.01	0.01	0.01	0.01	0.01	0.01	
1425	0.02	0.04	0.05	0.06	0.07	0.09	0.10	0.11	0.13	0.14	0.15	0.16	0.18	0.20	0.23	0.00	0.00	0.00	0.01	0.01	0.01	0.01	0.01	0.01	0.01	0.02	
1750	0.02	0.04	0.06	0.07	0.09	0.10	0.12	0.14	0.15	0.17	0.18	0.20	0.21	0.24	0.27	0.00	0.00	0.00	0.01	0.01	0.01	0.01	0.01	0.01	0.02	0.02	
2850	0.03	0.06	0.08	0.11	0.13	0.15	0.18	0.20	0.23	0.25	0.27	0.29	0.32	0.36	0.41	0.00	0.00	0.01	0.01	0.01	0.02	0.02	0.02	0.03	0.03	0.03	
3450	0.03	0.06	0.09	0.12	0.14	0.18	0.21	0.23	0.27	0.29	0.32	0.34	0.37	0.43	0.48	0.00	0.00	0.01	0.01	0.02	0.02	0.03	0.03	0.04	0.04	0.04	
500	0.01	0.02	0.02	0.03	0.03	0.04	0.04	0.05	0.05	0.06	0.06	0.07	0.07	0.08	0.09	0.00	0.00	0.00	0.00	0.00	0.00	0.00	0.00	0.00	0.00	0.01	
600	0.01	0.02	0.02	0.03	0.04	0.04	0.05	0.06	0.06	0.07	0.07	0.08	0.08	0.10	0.11	0.00	0.00	0.00	0.00	0.00	0.00	0.00	0.00	0.00	0.01	0.01	
700	0.01	0.02	0.03	0.04	0.04	0.05	0.06	0.06	0.07	0.08	0.08	0.09	0.10	0.11	0.12	0.00	0.00	0.00	0.00	0.00	0.00	0.00	0.01	0.01	0.01	0.01	
800	0.02	0.02	0.03	0.04	0.05	0.06	0.06	0.07	0.08	0.09	0.09	0.10	0.11	0.12	0.14	0.00	0.00	0.00	0.00	0.00	0.00	0.01	0.01	0.01	0.01	0.01	
900	0.02	0.03	0.03	0.04	0.05	0.06	0.07	0.08	0.09	0.09	0.10	0.11	0.12	0.14	0.15	0.00	0.00	0.00	0.00	0.00	0.01	0.01	0.01	0.01	0.01	0.01	
1000	0.02	0.03	0.04	0.05	0.06	0.07	0.08	0.09	0.10	0.10	0.11	0.12	0.13	0.15	0.17	0.00	0.00	0.00	0.00	0.00	0.01	0.01	0.01	0.01	0.01	0.01	
1200	0.02	0.03	0.04	0.06	0.06	0.08	0.09	0.10	0.11	0.12	0.13	0.14	0.15	0.18	0.20	0.00	0.00	0.00	0.00	0.01	0.01	0.01	0.01	0.01	0.01	0.01	
1400	0.02	0.04	0.05	0.06	0.07	0.09	0.10	0.11	0.13																		

## I. Operating Characteristics

### A. High Speed Drives

One major advantage of Gates Polyflex JB and Micro-V belts is the ability to operate smoothly and efficiently at high belt and shaft speeds. For example, shaft speeds of 30,000 rpm and higher have been achieved with smaller Polyflex JB cross sections. Polyflex JB and Micro-V belts both have the ability to transmit power to shafts turning at high speed mainly because the self-imposed centrifugal force acting on it is low.

Centrifugal tension occurs in a belt because of centrifugal force – the belt is rotating around the drive. Two things govern the magnitude of centrifugal tension acting in a belt drive:

- (1.) The size of the belt (cross-sectional mass).
- (2.) The speed the belt is traveling.

The relationship of these items is expressed in the following formula:

$$T_c = MV^2$$

Where:  $T_c$  = Centrifugal tension, (lb)

$M$  = Belt mass constant

$V$  = Belt speed, (ft/min)

The formula shows, as the size (mass) of the belt increases, centrifugal tension increases. But, more influential is speed, which increases exponentially.

Because a V-belt is basically a tension carrying member, its horsepower rating increases with speed until a maximum value is reached, as illustrated in Fig. 23. As belt speed increases, the increase in centrifugal tension creates a need to increase the installation tension so the desired running tension is obtained. Beyond this point, centrifugal tension increases to such a level it starts to reduce the available working tension, causing the horsepower rating to drop off. (See Fig. 23).

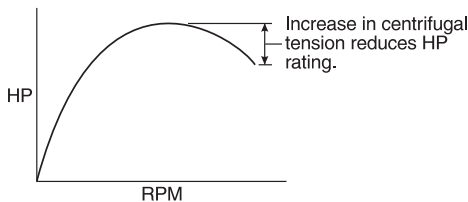

**Figure 23 - Available Belt Working Tension**

Polyflex JB belts have proportionally higher horsepower ratings than any other conventional type V-belt. This is due mainly to the belt cross-sectional shape and special polyurethane material, as previously described. For high speed drives, this higher horsepower rating is further extended because the rotating mass of Polyflex JB belts is reduced - smaller cross section, lighter material. Because of these unique characteristics, Polyflex JB belts may be applied on high speed drives where other belt types cannot be used.

### B. Smooth Running

Gates Polyflex JB and Micro-V belts are the smoothest running V-belt drives available. For most applications, conventional V-belts transmit power from the driveR to driveN shafts very smoothly, with a minimum of vibration. Some high speed, high precision equipment may demand better performance than a conventional V-belt which is designed mainly for heavy duty, industrial power transmission.

Smooth running characteristics of a belt drive are determined by measuring the variation in center distance as the belt slowly rotates around sheaves on a special measuring machine. The machine uses one shaft on a movable base and holds the belt at constant measuring tension. There are no industry standards prescribing levels of smooth running performance. When smooth running is specified as a special requirement, most manufacturers will only supply these belts on a made-to-order basis.

Conventional V-belts are usually manufactured by plying up layers of various rubber stocks, fabric and tensile cord. In most applications, the layers and overlaps do not disturb the drive operation. But, as speeds increase and sheave diameters decrease, or the machinery supporting the drive becomes more sensitive or compliant, the small discontinuities in the layers, coupled with overlaps in fabric, become much more apparent with respect to smooth running.

Due to the special patented manufacturing process, Polyflex JB belts have exceptionally smooth operating characteristics. Belts are cast in polyurethane and precision ground to assure the best possible cross sectional uniformity. The result is low center distance variation and minimal vibration.

Gates Micro-V belts also have excellent smooth running characteristics. Micro-V and Polyflex JB drives have been used extensively on applications such as precision grinders, medical equipment, office equipment, business machines, etc. where smooth running is an essential performance requirement.

### C. Noise

Polyflex JB and Micro-V drives generate minimal noise levels when installed and operating properly. They can, however, generate noise in adverse conditions such as misalignment, improper tension, under design, etc.

Since Polyflex JB belts have a polyurethane body with a high coefficient of friction, they may react on a steel surface causing noise, particularly on a misaligned drive. When a drive is misaligned the V-belt will not enter the sheave groove properly. It will stick and rub heavily on the side on the sheave causing noise. (See Fig. 24). Low belt tension can also be a source of noise problems. (See Section III. *Drive Alignment* and Section IV. *Belt Tensioning*, page 93-94.)

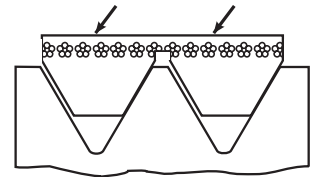

**Figure 24 - Misaligned Belt Entry**

Ribs molded laterally across the top of Polyflex JB belts help to reduce bending stresses and increase torsional stiffness. Because of the ribbed overcord, a backside idler may generate objectionable noise. The sound level produced is usually inversely proportional to the pulley diameter. So, the larger the pulley diameter, the lower the noise level. Backside idlers should be as large as possible. See Table 43, Page 96, Minimum Sheave Diameter for more information on backside idler recommendations.

## I. Operating Characteristics – Continued

Micro-V belts can be prone to slippage when installed with less than adequate tension, or when operating on a drive system with flexing centers. This potential slippage can result in noise. See Section IV. *Belt Tensioning* on Page 93.

In many cases the belt drive system is not the primary cause of noise. Undersized, poorly lubricated, worn or misaligned bearings can cause significant noise levels. Rotating parts of a total system can create air movement patterns that generate noise. A weak structure could flex under the load and cause misalignment and affect components in the drive system, thereby creating noise. Also, make sure that the total system has not been designed into an echo chamber, amplifying an otherwise insignificant noise.

### D. Static Conductivity

Polyflex JB belts do not meet the static-conductive requirements specified in ARPM\* Bulletin IP-3-3. This bulletin describes those belt characteristics necessary for safe operation in potentially explosive or flammable environments. However, laboratory testing confirms that under dynamic operating conditions, Polyflex JB belts are non-static generating. Under normal operating conditions, Polyflex JB belts do not build up significant static charge.

When Polyflex JB belts are used in explosive or flammable environments, additional steps must be taken to protect against accidental static spark discharges:

- (1) The entire system must be properly grounded.
- (2) A static conductive brush or similar device is recommended to bleed off any static buildup on the belt if it should occur.

The nonstatic generating characteristics apply to new, clean belts. It is the user's responsibility to establish an effective preventive maintenance program to monitor equipment and to replace or repair components, as needed, for continued safe operation.

Micro-V belts do meet the static conductive requirements specified in ARPM\* Bulletin IP-3-3 describing the characteristics necessary for safe operation in potentially explosive or flammable environments. This applies to new clean belts. Belt conductivity properties can be influenced by age and environmental debris.

\* Association of Rubber Products Manufacturers (Formerly RMA)

## II. Calculating Speed Ratio

Nominal pitch is satisfactory for use in speed calculations on most drives. Most machines do not require exact driveN speeds to operate efficiently, and speeds vary because the speed of common driveR machines usually varies by several percent. For example, the speed of an ordinary induction type electric motor varies with load and line voltage.

Speed ratio may be determined by the following formula:

$$\text{Speed Ratio} = \frac{\text{DriveN Pitch Diameter}}{\text{DriveR Pitch Diameter}}$$

Find the pitch diameters of the sheaves by adding the appropriate factor listed in Table 33 on Page 85 to the sheave outside diameters.

### E. Operating Environments

Caution should be used when installing Polyflex JB and Micro-V belt drives where debris is present. Debris can damage belts by becoming wedged between the belt's strands, causing damage or separation. Debris can also cause belts to become unstable and turn over. If the drive must operate in this type of environment, be sure to provide adequate shielding.

Since Polyflex JB belts use a 60° angle system, the coefficient of friction between the belt and sheave is extremely important. Any substance which decreases the coefficient of friction can cause belt slip. If the belt slips excessively, enough heat may be generated to cause catastrophic failure. Environmental contamination can also cause Micro-V belts to slip.

Polyflex JB belt performance is generally unaffected in ambient temperature environments between -65°F and +185°F (-54°C and +85°C). Micro-V belts are capable of operating between -30°F and +180°F (-34°C and +82°C). Contact Gates Product Application Engineering if the drive must operate in temperatures that exceed these limits.



## III. Drive Alignment

The “high performance” features (high HP capacity, smooth running, etc.) of Gates Polyflex JB and Micro-V belt drives may be realized on drives where proper sheave alignment is maintained. Polyflex JB and Micro-V belts should not be used on twisted or turned drives, or where shaft misalignment can exceed the amount specified in the following text. Sheave misalignment can cause belt instability, belt and sheave wear, strand separation, noise or excessive machine vibration.

There are two types of misalignment:

- Parallel
- Angular

Parallel misalignment occurs when the driveR and driveN shafts are parallel, but the sheave faces are in different planes. When the two shafts are not parallel the drive is angularly misaligned. Fig. 25 illustrates both parallel and angular misalignment. The fleeting angle is the angle at which the belt enters and exits the sheave and is the sum of parallel and angular misalignment.

Any degree of sheave misalignment will result in a reduction in belt life which is not accounted for in the normal drive design procedure. Misalignment of Polyflex JB and Micro-V belt drives should not exceed 1/4° or about 1/16 inch offset per foot of linear distance.

One easy way to check alignment is to use a straightedge checking alignment in both directions. In other words, lay the straightedge across the face of the driveN sheave and check driveR alignment. Then lay the straightedge across the driveR and check the positioning of the driveN sheave. This procedure will check for both parallel and angular misalignment. (Make sure the groove location from the sheave face is equal for both sheaves. If they are not equal, allow for the difference when measuring alignment.)

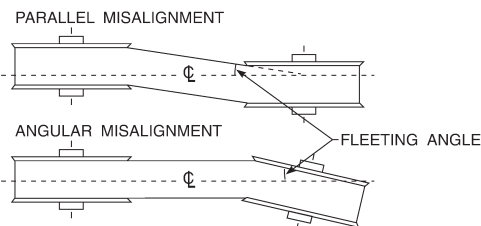

Figure 25 – Types of Misalignment

## IV. Belt Tensioning

In order to obtain full benefit of all the performance advantages offered by using Polyflex JB and Micro-V drives on various applications, special attention is required for belt tensioning. Excessive belt slip can result from low belt tension or improper drive design. If a Polyflex JB belt slips, enough heat may be generated to cause catastrophic belt failure.

Tensioning Polyflex JB and Micro-V drives by “feel” may result in performance problems unless the installer has extensive experience with the particular drive assembly. The relatively small belts, coupled with proportionally higher horsepower capacity makes the belts “feel” tighter than they actually are. For example, 50 pounds tension in a large industrial V-belt may not remove the sag, whereas 50 pounds in a 5M or J section belt makes them feel quite snug.

It is common practice to measure installation tension. Numerical methods for measuring tension have several advantages. For example, they prevent over or under tensioning a drive, thus preventing possible bearing or belt damage.

The procedures that follow explain how to properly pre-tension a drive when it is stopped (static tension) so belt tension will be correct when the drive is operating. Static tension (sometimes referred to as installation tension) can be measured by the force-deflection method. The amount of force needed to deflect a belt a known amount (see Fig. 26) is measured and compared to the recommended force. Adjustments can then be made as needed.

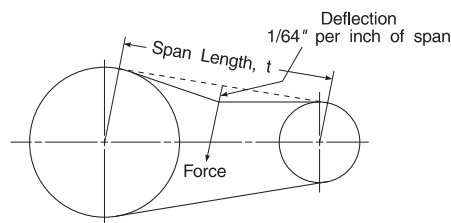

Figure 26 - Belt Deflection Distance

**Step 1. Calculate the required static tension per strand.**

### Formula 11 – English Units

$$T_{st} = 15 \left( \frac{B - G}{G} \right) \frac{(HP) (10^3)}{(N_b) (V)} + \frac{MV^2}{10^6}, \text{ lb.}$$

Where:  $T_{st}$  = Static tension (lb), per strand.

B = Belt type (5M Polyflex JB = 2.50, J Micro-V = 2.67)

G = Arc correction factor from Table 34, Page 86

HP = Driver load in horsepower

$N_b$  = Number of Belts (This is the total number of strands or ribs on the drive.)

V = Belt speed (ft/min; Formula 12, page 93)

M = Constant from Table 39.

PD = Pitch Diameter (in)  
(See Table 33, Page 85.)

### Formula 12 – English Units

$$V = \frac{(PD) (rpm)}{3.82}, \text{ ft/min}$$

**Table 39 – Factor m, Y and Minimum  $T_{st}$  (English)**

Cross Section	M	Y	*Minimum $T_{st}$ (lb)
3M Polyflex JB	0.030	1.00	5.0
5M Polyflex JB	0.050	1.20	8.0
J Micro-V	0.035	0.56	2.8

### Formula 13 – Metric Units

Where:  $T_{st}$  = Static tension in Newtons, per strand

$$T_{st} = 450 \left( \frac{B - G}{G} \right) \frac{(kW)}{(N_b) (V)} + (MV^2), \text{ N}$$

B = Belt type (5M Polyflex JB = 2.50, J Micro-V = 2.67)

G = Arc correction factor from Table 34, Page 86

KW = DriveR load in kilowatts

$N_b$  = Number of Belts (This is the total number of strands or ribs on the drive.)

V = Belt speed (m/s; Formula 14, Page 94)

M = Constant from Table 40, Page 94

PD = Pitch Diameter (mm)  
(See Table 33, Page 85.)

## IV. Belt Tensioning – Continued

### Formula 14 – Metric Units

$$V = \frac{(PD)(RPM)}{19100}, \text{ m/s}$$

**Table 40 – Factor M, Y and Minimum T<sub>st</sub> (Metric)**

Cross Section	M	Y	*Minimum T <sub>st</sub> (Newtons)
3M Polyflex JB	0.005	1.8	22.2
5M Polyflex JB	0.009	2.2	35.6
J Micro-V	0.006	1.03	12.5

Note: \*If the value of T<sub>st</sub>, calculated in Step 1, is less than the Minimum T<sub>st</sub> in Table 39 or 40, use the Minimum T<sub>st</sub> value from the table for T<sub>st</sub> to calculate Minimum and Maximum deflection forces in Step 2. The minimum value must be used on lightly loaded drives due to belt stiffness so the belt will properly conform to the sheave.

### Step 2. Calculate the minimum and maximum recommended deflection forces per strand.

- A. Measure the span length (t) on the drive or calculate span length (t) using the formula below:

#### Formula 15

Where: t = Span length, inches

$$t = CD \left[ 1 - 0.125 \left( \frac{D-d}{CD} \right)^2 \right]$$

CD = Center distance, inches

D = Large sheave or pulley diameter, inches

d = Small sheave diameter, inches

- B. If the drive uses only a single, 2, 3, 4 or 5-strand Polyflex JB belt, calculate the minimum and maximum recommended deflection force using these formulas.

#### Formula 16 – English Units

$$\text{Deflection Force per strand, Min.} = \frac{T_{st} + \left( \frac{t}{L_e} \right) Y}{16}, \text{ lb.}$$

#### Formula 17 – English Units

$$\text{Deflection Force per strand, Max.} = \frac{1.5 T_{st} + \left( \frac{t}{L_e} \right) Y}{16}, \text{ lb.}$$

Where: T<sub>st</sub> = Static tension per strand from Step 1.

Y = Constant from Table 39, page 93

t = Span length, inches

L<sub>e</sub> = Effective Belt length, inches

### Formula 18 – Metric Units

$$\text{Deflection Force per strand, Min.} = \frac{T_{st} + \left( \frac{t}{L_e} \right) Y}{25}, \text{ N}$$

### Formula 19 – Metric Units

$$\text{Deflection Force per strand, Max.} = \frac{1.5 T_{st} + \left( \frac{t}{L_e} \right) Y}{25}, \text{ N}$$

Where: T<sub>st</sub> = Static tension per strand from Step 1.

Y = Constant from Table 40

t = Span length, millimeters

L<sub>e</sub> = Effective Belt length, millimeters

- C. If the drive uses two or more Polyflex JB belts (should be matched sets), calculate the minimum and maximum recommended deflection forces using the formula below:

#### Formula 20 – English Units

$$\text{Deflection Force per strand, Min.} = \frac{T_{st} + Y}{16}, \text{ lb.}$$

#### Formula 21 – English Units

$$\text{Deflection Force per strand, Max.} = \frac{1.5 T_{st} + Y}{16}, \text{ lb.}$$

Where: T<sub>st</sub> = Static tension per strand from Step 1.

Y = Constant from Table 39, page 93.

#### Formula 22 – Metric Units

$$\text{Deflection Force per strand, Min.} = \frac{T_{st} + Y}{25}, \text{ N}$$

#### Formula 23 – Metric Units

$$\text{Deflection Force per strand, Max.} = \frac{1.5 T_{st} + Y}{25}, \text{ N}$$

Where: T<sub>st</sub> = Static tension per strand from Step 1.

Y = Constant from Table 40.

- Step 3. Minimum and maximum deflection forces are calculated on a per strand or rib basis.** The values in Step 2 should be multiplied by the number of strands in the belt which is being deflected. For example, if a 3-strand Polyflex JB belt is to be deflected, the minimum and maximum deflection forces should be multiplied by 3.

### Step 4. Calculate the deflection distance.

The force deflection procedure is based on the following belt span deflection distances:

#### Formula 24

$$\text{Deflection distance} = \frac{t}{64}, \text{ inches; or} = \frac{t}{100}, \text{ mm}$$

Where: t = Span lengths

### Step 5. Apply the tension.

- A. Midway between the belt contact points on the two sheaves, apply a force perpendicular to the belt large enough to deflect it from its normal position by the amount calculated in Step 4. Be sure the force is distributed evenly across the belt top width. When pushing on a multiple strand belt, for example, it may be necessary to use a bar under the gauge to distribute the force equally on all strands. (This force can be applied by pushing the belt in or pulling it out.) At least one sheave should be free to rotate.
- B. Compare this deflection force with the range of forces calculated in Step 3.
1. If this force is less than the recommended minimum, the belt should be tightened.
  2. If this force is more than the recommended maximum, the belt should be loosened.

Ideally, the maximum deflection force should be used when installing the belts and they should be retensioned when the deflection force falls below the minimum value calculated in Step 2.

## V. Installation and Takeup Allowances

Like any power transmission belt drive, installation allowance is necessary for Polyflex JB and Micro-V drives to assure the belt can be installed without damage and then tensioned correctly. The standard installation allowance is the minimum decrease in center distance required to install the belt on the sheaves (See Fig. 27).

**NOTE:** A belt should never be rolled onto a sheave. This can damage tensile cords in the belt resulting in premature failure. The damage may be invisible and difficult to identify as the cause of failure. A rolled on belt, because of cord damage, may also elongate rapidly and run out of takeup.

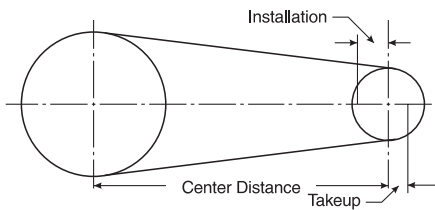

**Figure 27 – Installation and Takeup**

Takeup allowance is the increase in center distance which permits retensioning the belt due to wear and elongation. Takeup values lower than standard practice may not permit full belt life and could be a cause for excessive slipping.

Installation and takeup allowances are listed in Tables 41 and 42.

## VI. Idler Usage

**Table 41 – 5M Polyflex JB Installation and takeup Allowances**

Standard Effective Length	Center Distance Allowance for			
	Installation		Takeup	
	(in)	(mm)	(in)	(mm)
175 - 300	0.4	10	0.2	5
307 - 710	0.6	15	0.6	15
730 - 1090	0.9	25	1.1	30
1120 - 1500	1.1	30	1.4	35

**Table 42 – J Micro-V Installation and Takeup Allowances**

Standard Effective Length	Center Distance Allowance for			
	Installation		Takeup	
	(in)	(mm)	(in)	(mm)
Up through 20.0	0.4	10.2	0.3	07.6
20.1 through 40.0	0.5	12.7	0.5	12.7
40.1 through 60.0	0.6	15.2	0.7	17.8
60.1 through 80.0	0.7	17.8	0.9	22.9
80.1 through 100.0	0.8	20.3	1.1	27.9

Idlers are either grooved sheaves or flat pulleys which do not transmit power. They are used in Polyflex JB and Micro-V drives to perform these functions:

- Provide takeup for fixed center drives.
- Maintain belt tension; i.e., when the idler is spring-loaded or weighted.
- Increase arc of contact on critically-loaded sheaves.
- Break up long spans where span vibration or belt whip may be a problem.
- Clear obstructions.

**NOTE:** An idler can solve the design problems above. Since an idler always imposes additional bending stresses on the belt, it usually is best to design the drive without idlers if possible. Also, from an economic standpoint, it is generally more cost effective to provide takeup by movement of either the driveR or driveN shaft rather than by inserting an idler.

When using idlers, certain principles should be followed to obtain the best possible drive and to minimize common idler problems. The important design considerations are:

- Placement in the drive (inside vs. outside).
- Placement on tight or slack sides.
- Idler location in span.
- Diameter.
- Grooved or flat.
- Center distance, belt length, installation and takeup.

Idlers may be placed either inside or outside the drive, as shown in Fig. 28 and Fig. 29.

An inside idler decreases the arc of contact on the adjacent sheaves; whereas, a backside idler increases the arc of contact on the adjacent sheaves. Either may be used, but a backside idler must be larger (See B. *Idler Diameters* on Page 96). If a backside idler is used for belt takeup, the idler penetration (amount of takeup) is limited by the belt span on the opposite side of the drive.

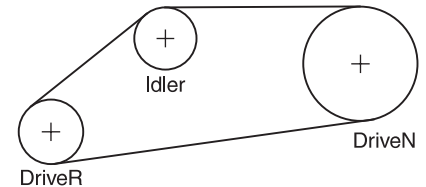

**Figure 28 – Inside Idler**

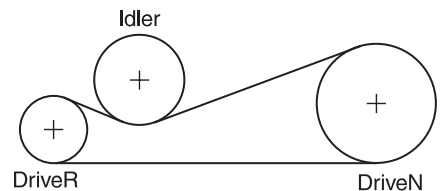

**Figure 29 – Outside or Backside Idler**

Backside idlers are always flat pulleys, since they contact the top of the Polyflex JB or Micro-V Belt. Inside idlers can be either flat or grooved. If they are grooved, the idler sheave must be machined correctly for the specific belt cross section. (See Sections VIII. *Polyflex JB Sheave Groove Specifications* and IX. *Micro-V Pulley Groove Specifications* on pages 98 and 99.)

### A. Idler Placement In the Span

**Idler position in the span with respect to other sheaves.**

A grooved inside idler may be located at any point in the span, but preferably so that it results in nearly equal arcs of contact on the two adjacent sheaves. See Fig. 30 on Page 96.

## VI. Idler Usage – Continued

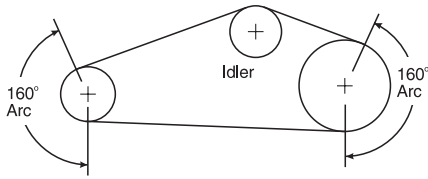

**Figure 30 – Equal Arcs**

A flat idler pulley (inside or backside) should be positioned in the span so that the distance between the idler and the sheave following the idler (in the direction the belt is traveling) is reasonably large. See Fig. 31 below. In this position, possible misalignment due to belt tracking will be minimized because the increased span length allows the belt to “realign” itself before entering the adjacent sheave. This, however, reduces the amount of idler movement available for belt takeup.

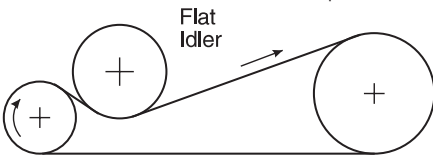
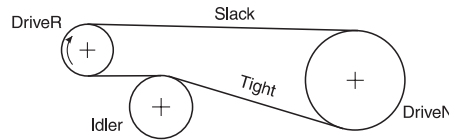

**Figure 31 – Locating Flat Idler**

In certain applications that have long belt spans and moderate shock loading, span vibration or belt whip may occur. If this happens, span vibration can be minimized by breaking up the long belt spans with contact idlers.

### Tight or slack spans

Figs. 32 and 33 show the idler positioned on the tightside and slackside spans of the drive.



**Figure 32 – Tightside Idler**

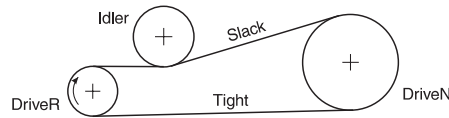

**Figure 33 – Slackside Idler**

If possible, the idler should be placed on the slackside span of the drive (See Fig. 33) rather than on the tightside.

The span tension directly influences the amount of stress on the belt. Since the operating tensions are lower in the slackside span, the belt stresses are significantly reduced when the idler is placed in this span. Reduced belt stresses reduce the amount of belt fatigue, resulting in longer belt life.

Spring-loaded idlers provide belt tension proportional to the load being transmitted. A useful paper, “Spring-Loaded Idler Designs for V-Belt Drives” ASAE Paper No. 75-1524 is available from Gates Product Application Engineering upon request.

This text describes proper design and analysis procedures, as well as a comparison between the operating characteristics of spring-loaded (automatic) and manual tensioning systems.

Spring-loaded or weighted idlers should always be located on the slackside because the spring force, or weight, can be much less in this position. In addition, these idlers should not be used on a drive where the load can be reversed; i.e., where the slackside can become the tightside.

Contact Gates Product Application Engineering for assistance in determining the force which idlers must impose on belts. The idler force must be such that the resulting belt tension in the span over the idler is equal to the slack span operating tension. Calculate the span operating tensions using the procedure outlined in *Section X. Belt Pull and Bearing Loads* on Page 100.

### B. Idler Diameters

Idler diameters should be at least as large as the recommended sheave diameters in Table 43.

**Table 43 – Minimum Recommended Idler Diameters**

Belt Cross Section	Min. O.D. of Grooved Idler (in)	Min. O.D. of Flat Inside Idler (in)	Min. O.D. of Outside or Backside Idler (in)
3M Polyflex JB	0.67	0.49	1.80
5M Polyflex JB	1.04	0.78	2.90
J Micro-V	0.80	0.65	1.25

### C. Grooved or Flat

Inside idlers may be either grooved or flat, and backside idlers should always be flat.

It is important to remember an outside idler on the ribbed back of Polyflex JB belts may be noisy. For additional information, refer to *Section I, Part C* on Page 91.

### D. Idler Details

Flat idlers should not be crowned. However, flanging of idlers is good practice. If flanges are used, the inside bottom corner should not be rounded because this may cause the belts to climb off the pulleys.

Brackets for idlers should be rigid. Drive problems described as “belt stretch,” “belt instability,” “short belt life,” “belt vibration” and others are frequently traced to flimsy idler bracketry. This bracketry must be designed to withstand the forces imposed by the operating belt tensions.

## VII. Design of Drives With Idlers

To calculate the proper belt length and required installation and takeup allowances for a drive that uses idlers, follow the procedure below.

### Step 1

Use the Drive Selection procedures on Pages 85-90 to determine the service factor, design horsepower per strand or rib, proper cross-section and driveR/driveN sheave combination required for your drive. The required center distance between the driveR and driveN shafts should be known.

### Step 2

Using the idler guidelines outlined in Section VI. *Idler Usage* on Page 95, select the diameter and placement of the idler(s) needed for the drive.

### Step 3

Find a first-trial belt effective length by using the known center distance and selected sheave effective outside diameters (EOD) in Formula 25 below:

#### Formula 25

$$\text{Belt Effective Length (in)} = 2CD + 1.57(D + d) + \frac{(D - d)^2}{4CD}$$

Where: D = Large sheave, outside diameter, inches  
 d = Small sheave, outside diameter, inches  
 CD = Center distance, inches

### Step 4

Find the appropriate installation allowance for this first-trial belt length from Table 41 or Table 42 on Page 95. Multiply the installation allowance by 2 when working with belt effective length since Tables 41 and 42 are based upon center distance. Add installation allowance to trial length. If this is a nonstandard length, select the next larger standard belt length for the drive.

### Step 5

Determine the maximum belt length for takeup. For the standard belt length selected in Step 4, find the takeup allowance in Table 41 or Table 42 on Page 95. Multiply this takeup allowance by 2 and add it to the standard belt effective length to determine the maximum belt effective length for takeup.

### Step 6

Lay out the drive to scale using the selected diameters and centers. Using a trial-and-error method, position the idler in several locations until the correct belt effective length is obtained.

There are several methods to calculate belt effective length from a drive layout; i.e. a map-measuring device, or digitizer can be used to trace around the line indicating the belt length.

Another method involves measuring all the span lengths, and adding them to the arc lengths (the length of belt contacting the sheaves). Measure each arc of contact (wrap) with a protractor and calculate each arc length using Formula 26.

#### Formula 26

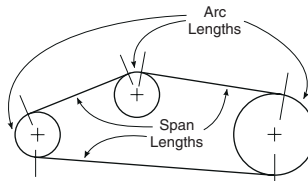

Arc Length =  $\pi \times$  Arc of Contact  $\times$  Diameter of Sheave

NOTE:  $\pi = 3.1416$

### Step 7

Using the trial-and-error method, locate the idler in the minimum (belt installation) and maximum (belt takeup) positions. This step assures the idler has adequate movement to provide sufficient installation and takeup allowances. (NOTE: The minimum and maximum idler positions should reflect the actual bracketry design used to support the idler assembly). Measure each arc of contact.

### Step 8

From Steps 6 and 7, examine the three drive layouts (installation, nominal and maximum belt lengths) and determine the smallest arc of contact for each loaded sheave or pulley. Find the appropriate Factor G in Table 44 for each of these sheaves.

**Table 44 – Arc of Contact Correction Factor (G)**

Arc of Contact on Small Sheave (degrees)	Arc Correction Factor G		Arc of Contact on Small Sheave (degrees)	Arc Correction Factor G	
	Polyflex JB	Micro-V		Polyflex JB	Micro-V
230	1.09	1.11	160	.95	.94
220	1.08	1.09	150	.92	.91
210	1.06	1.07	140	.89	.88
200	1.04	1.05	130	.86	.84
190	1.02	1.02	120	.82	.80
180	1.00	1.00	110	.78	.76
170	.98	.97	100	.74	.72

NOTE: Use the smallest Factor G in the following design steps.

### Step 9

Find the rated horsepower per strand or rib, using the smallest diameter loaded sheave in the drive, from the tables on Page 88, 89, or 90. Based on the standard belt length selected, determine the belt length correction factor  $K_L$  from Table 35 or Table 36 on Page 86. Calculate the corrected horsepower per strand or rib by multiplying the rated horsepower per strand or rib by the factor G and the belt length correction factor  $K_L$  determined above.

Calculate the horsepower per strand or rib by multiplying the corrected horsepower per strand or rib by the appropriate Idler Correction Factor in Table 45 below.

**Table 45 – Idler Correction Factor**

No. of Idlers in Drive	Idler Correction Factor
0	1.00
1	0.91
2	0.86
3	0.81

Determine the number of strands or ribs required by dividing the design horsepower by the horsepower per strand or rib. The answer may contain a fraction. Always round to the next larger whole number of strands or ribs.

Subminimal idler diameters (smaller than recommended) are the single largest cause of problems with idler drives. These diameters impose additional stresses in the belt that will result in short belt life even if the number of strands or ribs is determined using the procedure above. Contact Gates Product Application Engineering for possible recommendations if subminimal sheaves must be used.

## VIII. Polyflex JB Sheave Groove Specifications

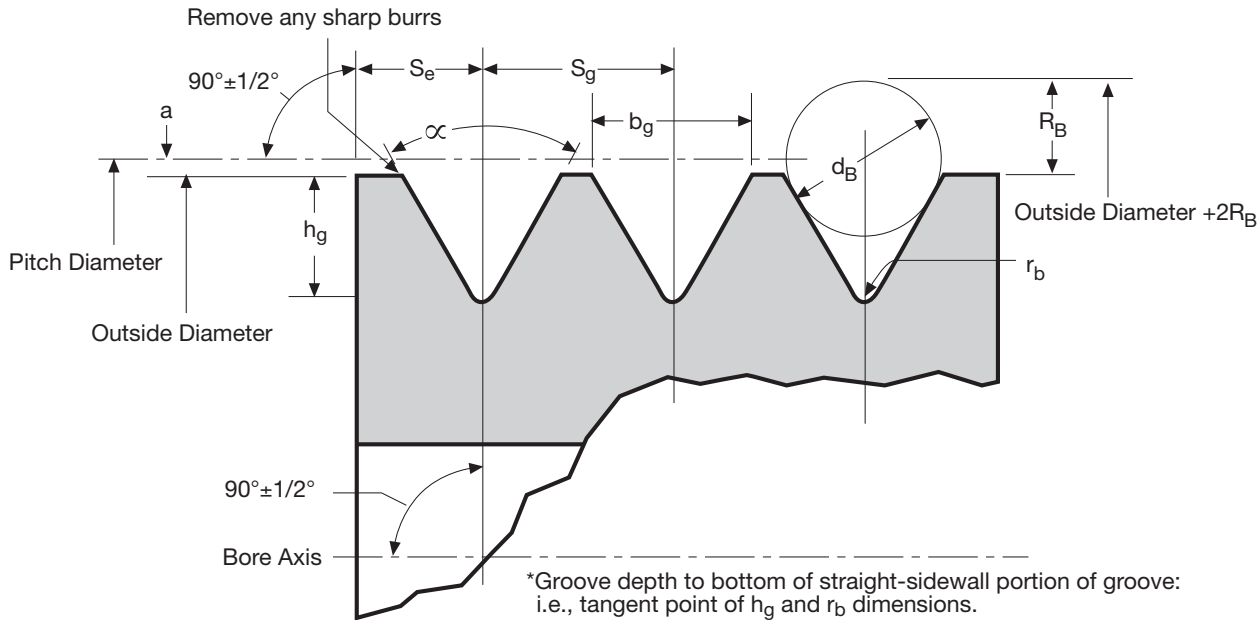

**Table 46 – 3M and 5M Polyflex JB Sheave Groove Specifications**

Cross Section	Minimum Recommended Outside Diameter (in)	2a PD to OD Value (in)	bg Groove Top Width ±0.002 (in)	Sg Groove Spacing +0.005 -0.002 (in)	Se Edge Spacing Minimum (in)	rb Bottom Radius Maximum (in)	Groove Angle		hg Groove Depth Reference* (in)	2RB Two Times Ball Extension ±0.005 (in)	db Ball or Rod Diameter ±0.0005 (in)
							Outside Diameter Range (in)	Groove Angle ±1/4° (Degrees)			
3M	0.67	0.023	0.110	0.132	0.088	0.012	0.67 -0.90	60	0.077 0.074	0.184 0.185	0.1250
							Over 0.90	62			
5M	1.04	0.030	0.177	0.209	0.136	0.016	1.04 -1.26	60	0.129 0.124 0.120	0.209 0.211 0.213	0.1719
							1.27 -3.80	62			
							Over 3.80	64			

### NOTES:

- The sides of the groove shall not exceed 125 micro inches (RMS) roughness.
- The summation of deviations from  $S_g$  for all grooves in any one sheave shall not exceed  $\pm 0.015$ ".
- The variation in diameter over-ball (Outside Diameter +  $2R_B$ ) shall not vary from groove to groove in any one sheave more than:  
3M: 0.001" 5M: 0.002"
- The tolerance on outside diameter shall be:  
Less than 1.00" O.D. ....  $\pm 0.001$ "  
Over 1" and including 2.00" O.D. ....  $\pm 0.002$ "  
Over 2" and including 5.00" O.D. ....  $\pm 0.005$ "  
Over 5" and including 10.00" O.D. ....  $\pm 0.010$ "  
Over 10" and including 20.00" O.D. ...  $\pm 0.020$ "  
Over 20.00" O.D. ....  $\pm 0.040$ "

### Outside Diameter Eccentricity

Radial runout shall not exceed 0.005" TIR\*\* for outside diameters up through 10.0". Add 0.0005" TIR\*\* per inch of outside diameter for diameters more than 10.0".

### Side Wobble

Axial runout shall not exceed 0.001" TIR\*\* per inch of outside diameter for outside diameters up through 20.0". Add 0.0005" TIR\*\* per inch of outside diameter for diameters more than 20.0".

\*\*Total Indicator Reading

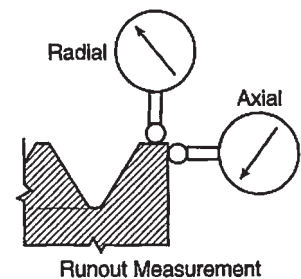



## IX. Micro-V Pulley Groove Specifications

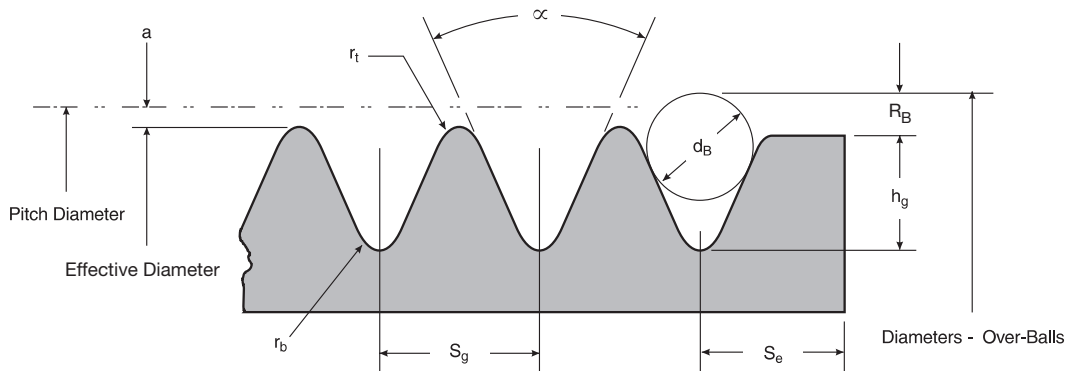

Where: Face Width =  $S_g(N_g - 1) + 2S_e$   
 $N_g$  = Number of grooves

**Table 47 – Micro-V Pulley Groove Specifications**

Cross Section	Minimum Recommended Effective Diameter (in)	2a (in)	$S_g^*$ (in)	$S_e$ Minimum (in)	$r_b$ Maximum (in)	$r_t$ +0.005 -0.000 (in)	$\alpha^{**}$ Groove Angle $\pm 1/2^\circ$ (Degrees)	$h_g$ Minimum (in)	$d_B \pm 0.0004$ (in)	$2R_B$ Minimum (in)	$2R_B$ Maximum (in)
H	0.50	0.063	0.063 $\pm 0.001$	0.051	0.012	0.006	40	0.041	0.0469	0.034	0.057
J	0.80	0.094	0.092 $\pm 0.001$	0.071	0.016	0.008	40	0.071	0.0625	0.023	0.046
K	1.8	0.157	0.140 $\pm 0.002$	0.098	0.020	0.010	40	0.122	0.1093	0.083	0.110

\*Summations of deviations from  $S_g$  for all grooves in any one pulley shall not exceed  $\pm 0.010$ .

\*\*The center line of the grooves shall make an angle of 90 degrees  $\pm 0.5$  degrees with the axis of the pulley bore.

### The variations in diameter-over-balls\*\*\* between the grooves in any one pulley must be within the following limits:

Up through 2.9" diameter and up through 6 grooves (Add 0.0001" for each additional groove)  
 .....0.004"

Over 2.9" diameter to and including 19.9" and up through 10 grooves (Add 0.0002" for each additional groove) ..... 0.006"

Over 19.9" diameter and up through 10 grooves (Add 0.0005" for each additional groove).....0.010"

This variation can be easily obtained by measuring the distance across two measuring balls or rods placed in the grooves diametrically opposite each other. Comparing this "diameter-over-balls or – rods" measurement between grooves will give the variation in pitch diameter.

### Other Pulley Tolerances

Outside Diameter:

Up through 2.9" O.D. ....  $\pm 0.010$ "

Over 2.9" to and including 8.0" O.D. ....  $\pm 0.020$ "

For each additional inch of O.D. over 8",  
 add .....  $\pm 0.0025$ "

Radial Runout:\*\*\*

Up through 2.9" O.D. ....0.005"

Over 2.9" to and including 10.0" O.D. ....0.010"

For each additional inch of O.D. over 10",  
 add ..... 0.0005"

Axial Runout:\*\*\*

0.002" per inch of outside diameter

\*\*\*Total Indicator Reading

## X. Belt Pull and Bearing Loads

Belt pull is the magnitude of force exerted on the sheaves by the belts. This force is often referred to as side load. Magnitude of the bearing load in driveR or driveN machines depends upon both the side load (shaft load) acting on the shaft and bearing locations with respect to side load. Side load is the combined load created by sheave weight and belt pull. In comparing these force components, the sheave weight is usually much less than belt pull and is typically ignored. However, critical applications requiring exacting shaft loading values should include sheave weights in the calculations. Belt pull is a function of the following variables:

1. Horsepower Transmitted – For the following given drive, horsepower is directly proportional to the belt pull; i.e., as the load increases, the belt pull also increases.
2. Belt Speed – For the same horsepower, higher belt speed (larger sheave diameters) reduces belt pull.
3. Arc of Contact – Reduced arc of contact (wrap) requires more tension to prevent belt slip. This increases the belt pull for the same horsepower load.
4. Total Drive Installation Tension – Minimum tension is required to keep Polyflex JB and Micro-V belts from slipping. However, if the installation tension is excessively high, the belt pull also will be higher than desired.

**NOTE:** Calculated belt pull is *independent of the number of belts or ribs* used on the drive. The number of belts or ribs only affects the amount of overhang from the center of belt pull to the bearings.

After accurately calculating belt pull, the designer can size the shafts and bearings required for the driveR and driveN equipment. It is important that the designer check the capacity of the shafts and bearings on both the driveR and driveN.

The driveR is usually an electric motor or engine. For electric motors, the belt pull is limited to an acceptable amount by either the recommended sheave diameters listed in Table 38 on Page 87 or by the minimum recommended diameters specified by the motor manufacturer.

Many handbooks show belt pull formulas that differ from formulas and procedures described in this section. These differences are the result of shortcuts that either ignore or average factors such as the arc of contact correction factor. The Gates method results in accurate calculations of belt pull for drives operating at design loads and tensions.

Belt tensions are based on a ratio between the tightside and slackside tensions. The design tension ratio for Polyflex JB drives is 5:1, and 4:1 for Micro-V, based upon 180° arc of contact. Design tension ratio is then corrected for the actual arc of contact.

The equipment designer should recognize that belts can be tensioned up to 1.5 times the design tension. (See Section IV. *Belt Tensioning* on Page 93 and 94. This higher tension expedites belt seating, but does not exist for the life of the drive. Shafts and bearings must be designed to tolerate these higher tensions for a reasonable amount of time without sustaining damage.

The following formulas are correct for Polyflex JB and Micro-V belt drives. When shaft load calculations are required, Gates recommends using the following formulas and procedures:

### Belt Pull Calculations

#### Step 1 Calculate the Drive Tensions.

Belt pull is the vector sum of  $T_T$  and  $T_S$ , the tightside and slackside tensions, respectively. Calculate these tensions using the formulas below.

#### Formula 27

$$T_T = \frac{41,250 \text{ (HP)}}{GV}, \text{ lb.} \quad \text{(Polyflex JB)}$$

#### Formula 28

$$T_S = 33,000 \frac{(1.25 - G) \text{ (HP)}}{GV}, \text{ lb.} \quad \text{(Polyflex JB)}$$

#### Formula 29

$$T_T = \frac{44,000 \text{ (HP)}}{GV}, \text{ lb.} \quad \text{(Micro-V)}$$

#### Formula 30

$$T_S = 33,000 \frac{(1.33 - G) \text{ (HP)}}{GV}, \text{ lb.} \quad \text{(Micro-V)}$$

Where:  $T_T$  = Tightside Tension, pounds

$T_S$  = Slackside Tension, pounds

HP = DriveR load in horsepower

V = Belt Speed (ft/min) = {(Pitch Diameter, in.) (rpm)} over 3.82

G = Arc of contact correction factor, (Table 34, Page 86.)

#### Step 2 Find the Vector Sum of $T_T$ and $T_S$ .

Calculate the magnitude and direction of the belt pull by summing the  $T_T$  and  $T_S$  vectors. The simplest method of calculating the belt pull vector is by graphical addition. After determining the belt pull vector, calculate true shaft loads by adding belt pull vectors to sheave weight vectors.

- A.** If only the magnitude of belt pull is needed, numerical methods for vector additions are faster than the graphical approach. If both magnitude and direction of belt pull are required, the vector sum of  $T_T$  and  $T_S$  can be calculated by graphical vector addition as shown in Fig. 34. The  $T_T$  and  $T_S$  vectors are parallel to the tightside and slackside, respectively, and they should be drawn to a convenient scale; i.e. 1 in. = 100 lb.

Fig. 34 shows the vector addition for belt pull on a motor shaft. Use the same procedures to determine the belt pull on the driveN shaft. This graphical illustration method should also be used for drives that have three or more sheaves or idlers.

For two-sheave drives, belt pull on the driveR and driveN shafts is equal but opposite in direction. For drives using idlers, both magnitude and direction may be different.

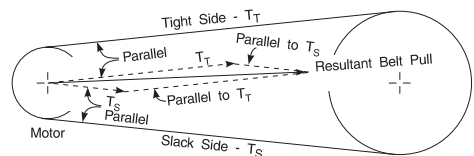

**Figure 34 – Graphical Addition of  $T_T$  and  $T_S$**

## X. Belt Pull and Bearing Loads – Continued

B. For a two-sheave drive that requires only the magnitude of belt pull, use Formula 31 below:

### Formula 31

$$\text{Belt Pull} = \sqrt{T_T^2 + T_S^2 + 2T_T T_S \cos(180 - \phi)}, \text{ lb.}$$

Where:  $T_T$  = Tightside tension, lb.

$T_S$  = Slackside tension, lb.

$\phi$  = Arc of contact on small sheave, degrees

$$\phi = 2 \cos^{-1} \left( \frac{D - d}{2CD} \right)$$

Where:  $D$  = Large Diameter, inches

$d$  = Small Diameter, inches

$CD$  = Center Distance, inches

Belt pull also may be determined by using the alternate procedure as follows:

1. Add  $T_T$  and  $T_S$  (from Step 1 on Page 100 to find  $T_T + T_S$  (arithmetic sum.)

2. Calculate  $\frac{D - d}{CD}$

Where:  $D$  = Large Diameter, inches

$d$  = Small Diameter, inches

$CD$  = Center Distance, inches

Use value calculated above to find the vector sum correction factor from Fig. 35 below.

Multiply  $T_T + T_S$  by the vector sum correction factor to find the true vector sum of  $T_T + T_S$ . This is the belt pull on either the driveR or driveN shaft.

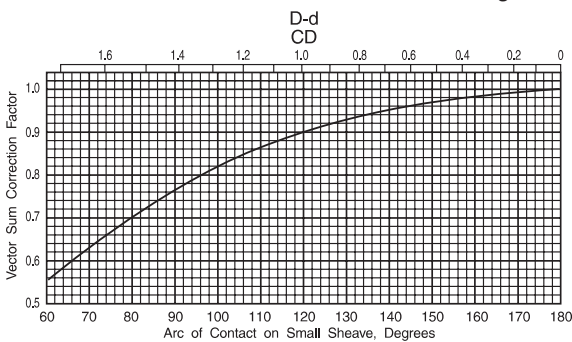

Figure 35 – Vector Sum Correction Factor

### Bearing Load Calculations

In order to find actual bearing loads, it is necessary to know the weights of machine components and the value of all other forces contributing to the load. However, sometimes it helps to know the bearing load contributed by the belt drive alone. The resulting bearing load due to belt pull can be calculated if both bearing spacing with respect to the sheave center and the belt pull are known. For approximate bearing load calculations, machine designers use belt pull and ignore sheave weight forces. If more accurate bearing load calculations are needed, or if the sheave is unusually heavy, the actual shaft load (including sheave weight) should be used.

#### A. Overhung Sheaves

### Formula 32

$$\text{Load at B} = \frac{\text{Shaft Load} \times (a + b)}{a}$$

### Formula 33

$$\text{Load at A} = \frac{\text{Shaft Load} \times b}{a}$$

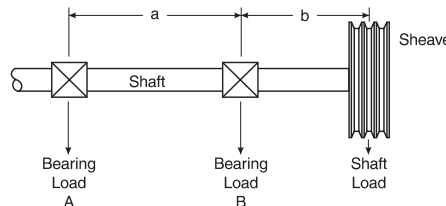

Figure 36 – Overhung Sheave

#### B. Sheave Between Bearings

### Formula 34

$$\text{Load at D} = \frac{\text{Shaft Load} \times c}{(c + d)}$$

### Formula 35

$$\text{Load at C} = \frac{\text{Shaft Load} \times d}{(c + d)}$$

Where:  $c$  and  $d$  = spacing (in). See Fig. 37 below.

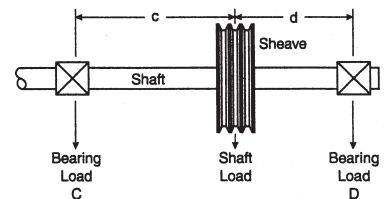

Fig. 37 – Sheave Between Bearings

## XI. Belt Storage and Handling

Below is a partial reprint of ARPM (Association for Rubber Products Manufacturers. Formerly RMA) Bulletin Number IP-3-4 which discusses general guidelines for storage of V-belts:

Storage of power transmission belts is of interest to users and distributors as well as manufacturers. Under favorable storage conditions, good quality belts retain their initial serviceability and dimensions. Conversely, unfavorable conditions can adversely affect performance and cause dimensional change. Good storage facilities and practices will allow the user to achieve the most value from belt products.

Power transmission belts should be stored in a cool and dry environment with no direct sunlight. When stacked on shelves, the stacks should be small enough to avoid excess weight on the bottom belts which may cause distortion. When stored in containers, the container size and contents should be sufficiently limited to avoid distortion, particularly to those belts at the bottom of the container.

### Some things to avoid:

Do not store belts on floors unless a suitable container is provided. They may be susceptible to water leaks or moisture or otherwise damaged due to traffic.

Do not store belts near windows which may permit exposure to sunlight or moisture. Do not store belts near radiators or heaters or in the air flow from heating devices.

Do not store belts in the vicinity of transformers, electric motors or other electrical devices that may generate ozone. Also avoid areas where evaporating solvents or other chemicals are present in the atmosphere.

Do not store belts in a configuration that would result in bend diameters less than the minimum recommended sheave or pulley diameter for normal bends.

Equipment using belts is sometimes stored for prolonged periods (six months or more) before it is put in service or during other periods when it is idle. It is recommended that tension

on the belts be relaxed during such periods and that equipment storage conditions should be consistent with the guidelines for belt storage. If this is not possible, belts should be removed and stored separately.

Handling of Polyflex JB and Micro-V belts is also important. Belts should not be crimped or tightly bent. Belts should not be bent inside tighter than the smallest recommended sheave diameter for that particular cross section. (See Table 43 on Page 96.) Backside bending should be limited to the values specified in Table 43 on Page 96.

Belts may be cleaned by wiping with a rag slightly dampened with a light nonvolatile solvent. Soaking or brushing on of such solvent is not advisable. The belt must be completely dry before using on the drive. More obviously, sanding or scraping the belt with a sharp object to remove grease or debris is not recommended.

# Useful Formulas and Calculations

## Drive Design

$$\text{Speed Ratio} = \frac{\text{rpm (faster)}}{\text{rpm (slower)}} = \frac{\text{PD}}{\text{pd}} = \frac{N}{n}$$

Where: rpm = Revolutions per minute

PD = Larger pitch diameter

pd = Smaller pitch diameter

N = Larger sprocket grooves

n = Smaller sprocket grooves

$$\text{Horsepower} = \frac{(Q)(\text{rpm})}{63025}$$

Where: Q = Torque, lb-in

rpm = Revolutions per minute

Be sure to use torque and rpm values at the same shaft; do not mix torque and rpm values from different shafts.

$$\text{Horsepower} = \frac{(T_e)(V)}{33,000}$$

Where:  $T_e$  = Effective tension, lb.

V = Belt speed, ft/min

$$\text{Design Horsepower} = \text{hp} \times \text{SF}$$

Where: hp = Horsepower

SF = Service Factor

$$\text{Torque (lb-in)} = \frac{63025 (\text{hp})}{\text{rpm}}$$

Where: hp = Horsepower

rpm = Revolutions per minute

$$\text{Design Torque} = Q \times \text{SF}$$

Where: T = Torque load

SF = Service factor

$$\text{Service Factor} = \frac{\text{Rated } T_a}{(T_e + T_c)}$$

Where:  $T_a$  = Rated belt working tension, lb.

$T_e$  = Effective tension, lb.

$T_c$  = Centrifugal tension, lb.

$$\text{Belt Speed (V)} = \frac{(\text{PD})(\text{rpm})}{3.82}$$

Where: V = Belt speed, ft/min

PD = Pitch diameter, in.

rpm = Revolutions per minute of same pulley

The exact belt pitch length, in inches, can be found as follows:

$$\text{Pitch Length} = 2(\text{CD})(\text{Cos } \phi) + \frac{\pi(\text{PD} + \text{pd})}{2} + \frac{\phi(\text{PD} - \text{pd})}{180}$$
$$\phi = \text{Sin}^{-1} \left( \frac{\text{PD} - \text{pd}}{2\text{CD}} \right)$$

Where: CD = Drive center distance, in.

PD = Large pitch diameter, in.

pd = Small pitch diameter, in.

The approximate center distance in inches can be found as follows:

$$\text{Center Distance} = \frac{K + \sqrt{K^2 - 32(\text{PD} - \text{pd})^2}}{16}$$

$$K = 4\text{PL} - 6.28(\text{PD} + \text{pd})$$

Where: PD = Large pitch diameter, in.

pd = Small pitch diameter, in.

PL = Belt pitch length, in.

The exact center distance can be calculated using an iterative process between the center distance and belt length equations above. The exact center distance has been found when the two equations converge.

$$\text{Span Length} = \sqrt{\frac{\text{CD}^2 - (\text{PD} - \text{pd})^2}{4}}$$

Where: PD = Large pitch diameter, in.

pd = Small pitch diameter, in.

CD = Drive center distance, in.

The arc of contact on the smaller pulley in degrees can be found as follows:

$$\text{Arc of Contact} = 180 - \left( \frac{60(\text{PD} - \text{pd})}{\text{CD}} \right)$$

Where: PD = Large pitch diameter, in.

pd = Small pitch diameter, in.

CD = Drive center distance, in.

# Useful Formulas and Calculations

## Drive Design - Continued

The number of teeth in mesh on the smaller sprocket can be found as follows:

$$\text{Teeth in Mesh} = \frac{(\text{Arc}) (n)}{360}$$

Where: Arc = Arc of contact; small sprocket, degrees

n = number of grooves, small sprocket

Drop any fractional part and use only the whole number as any tooth not fully engaged cannot be considered a working tooth.

If the teeth in mesh is less than 6, correct the belt torque rating with the following multiplication factors:

5 Teeth in Mesh – Multiply by 0.8

4 Teeth in Mesh – Multiply by 0.6

3 Teeth in Mesh – Multiply by 0.4

2 Teeth in Mesh – Suggest Redesign

1 Tooth in Mesh – Suggest Redesign

Torque loading due to flywheel effect (acceleration or deceleration) can be calculated as follows:

$$\text{Torque (lb-in)} = \frac{0.039(\text{RPM} - \text{rpm}) (\text{WR}^2)}{t}$$

Where: RPM = Final revolutions per minute

rpm = Initial revolutions per minute

WR<sup>2</sup> = Flywheel effect, pound-feet<sup>2</sup>

(lb-ft<sup>2</sup>) (1 ft-lb-sec<sup>2</sup> is equivalent to 32.2 lb-ft<sup>2</sup>)

t = time, seconds

The flywheel effect of a sprocket can be estimated as follows:

$$\text{WR}^2 (\text{lb-ft}^2) = \frac{(F) (Z) (D^4 - d^4)}{1467}$$

Where: F = Face width of rim, in.

Z = Material density, lb/in<sup>3</sup>

D = Outside rim diameter, in.

d = Inside rim diameter, in.

Typical Values: 2024 Aluminum - 0.100 lb/in<sup>3</sup>

6061 Aluminum - 0.098 lb/in<sup>3</sup>

Iron - 0.284 lb/in<sup>3</sup>

## Synchronous Belt Tension

### Effective Pull

$$T_e = T_T - T_S = \frac{2(Q)}{pd}$$

Where: T<sub>T</sub> = Tight side tension, lb.

T<sub>S</sub> = Slack side tension, lb.

Q = Torque Load, lb-in

pd = Pitch diameter, in.

T<sub>e</sub> = Effective tension, lb.

### Total Tension (8:1)

$$T_T + T_S = \frac{2.571(Q)}{pd}$$

Where: T<sub>T</sub> = Tight side tension, lb.

T<sub>S</sub> = Slack side tension, lb.

Q = Torque load, lb-in

pd = Pitch diameter, in

### Tight Side Tension (8:1)

$$T_T = \frac{2.286(Q)}{pd}$$

Where: T<sub>T</sub> = Tight side tension, lb.

Q = Torque load, lb-in

pd = Pitch diameter, in.

### Slack Side Tension (8:1)

$$T_S = \frac{0.285(Q)}{pd}$$

Where: T<sub>S</sub> = Slack side tension, lb.

Q = Torque load, lb-in

pd = Pitch diameter, in.

### Working Tension

$$T_w = (T_e + T_c) (SF)$$

Where: T<sub>w</sub> = Working tension, lb.

T<sub>e</sub> = Effective tension, lb.

T<sub>c</sub> = Centrifugal tension, lb.

SF = Service Factor

### Centrifugal Belt Tension

$$T_c = \frac{(M) (PD)^2 (\text{rpm})^2}{16.2 \times 10^6}$$

Where: T<sub>c</sub> = Centrifugal tension, lb.

M = Belt mass constant

PD = Smaller pitch diameter, in.

rpm = Smaller sprocket revolutions per minute

Belt Section	Belt Width	M
2MGT GT3	4mm	0.026
	6mm	0.039
	9mm	0.059
	12mm	0.078
3MGT GT3	6mm	0.078
	9mm	0.117
	12mm	0.156
	15mm	0.195
5MGT GT3	9mm	0.172
	12mm	0.229
	15mm	0.286
	25mm	0.476
Belt Section	Belt Width	M
3M HTD	6mm	0.067
	9mm	0.100
	15mm	0.167
5M HTD	9mm	0.163
	15mm	0.272
	25mm	0.453
MXL	1/8"	0.019
	3/16"	0.029
	1/4"	0.038
XL	1/4"	0.071
	3/8"	0.106



# Useful Formulas and Calculations

## Polyflex® JB® Belt Tension

### Effective Pull

$$T_T - T_S = 33,000 \left( \frac{hp}{V} \right) = T_e$$

Where:  $T_T$  = Tight side tension, lb.

$T_S$  = Slack side tension, lb.

hp = Horsepower

$V$  = Belt speed, ft/min

$T_e$  = Effective tension, lb.

### Total Tension (5:1)

$$T_T + T_S = 33,000 (2.5 - G) \left( \frac{hp}{GV} \right)$$

Where:  $T_T$  = Tight side tension, lb.

$T_S$  = Slack side tension, lb.

hp = Horsepower

$V$  = Belt speed, ft/min

$G$  = Arc of contact correction factor (Table 34, Page 86)

### Tension Ratio

$$T_T / T_S = \frac{1}{1 - 0.8G} \quad (\text{Also, } T_T / T_S = e^{K\theta})$$

Where:  $T_T$  = Tight side tension, lb.

$T_S$  = Slack side tension, lb.

$G$  = Arc of contact correction factor (Table 34, Page 86)

$e$  = Base of natural logarithms

$K$  = .51230, a constant for V-belt drive design

$\theta$  = Arc of contact in radians

### Tight Side Tension (5:1)

$$T_T = 41,250 \left( \frac{hp}{GV} \right)$$

Where:  $T_T$  = Tight side tension, lb.

hp = Horsepower

$V$  = Belt speed, ft/min

$G$  = Arc of contact correction factor (Table 34, Page 86)

### Slack Side Tension (5:1)

$$T_S = 33,000 (1.25 - G) \left( \frac{hp}{GV} \right)$$

Where:  $T_S$  = Slack side tension, lb.

hp = Horsepower

$V$  = Belt speed, ft/min

$G$  = Arc of contact correction factor (Table 34, Page 86)

## Micro-V® Belt Tension

### Effective Pull

$$T_T - T_S = 33,000 \left( \frac{hp}{V} \right) = T_e$$

Where:  $T_T$  = Tight side tension, lb.

$T_S$  = Slack side tension, lb.

hp = Horsepower

$V$  = Belt speed, ft/min

$T_e$  = Effective tension, lb.

### Total Tension (4:1)

$$T_T + T_S = 33,000 (2.67 - G) \left( \frac{hp}{GV} \right)$$

Where:  $T_T$  = Tight side tension, lb.

$T_S$  = Slack side tension, lb.

hp = Horsepower

$V$  = Belt speed, ft/min

$G$  = Arc of contact correction factor (Table 34, Page 86)

### Tension Ratio

$$T_T / T_S = \frac{1}{1 - 0.75G} \quad (\text{Also, } T_T / T_S = e^{K\theta})$$

Where:  $T_T$  = Tight side tension, lb.

$T_S$  = Slack side tension, lb.

$G$  = Arc of contact correction factor (Table 34, Page 86)

$e$  = Base of natural logarithms

$K$  = .44127, a constant for Micro-V drive design

$\theta$  = Arc of contact in radians

### Tight Side Tension (4:1)

$$T_T = 44,000 \left( \frac{hp}{GV} \right)$$

Where:  $T_T$  = Tight side tension, lb.

hp = Horsepower

$V$  = Belt speed, ft/min

$G$  = Arc of contact correction factor (Table 34, Page 86)

### Slack Side Tension (4:1)

$$T_S = 33,000 (1.33 - G) \left( \frac{hp}{GV} \right)$$

Where:  $T_S$  = Slack side tension, lb.

hp = Horsepower

$V$  = Belt speed, ft/min

$G$  = Arc of contact correction factor (Table 34, Page 86)

# Useful Formulas and Calculations

## Power Transmission Conversions

### Torque Conversion Constants

#### Metric to U.S.

Newton Meters x 141.6119 = Ounce Inches  
 Newton Meters x 8.8508 = Pound Inches  
 Newton Meters x 0.7376 = Pound Feet

#### U.S. to Metric

Ounce Inches x 0.0071 = Newton Meters  
 Pound Inches x 0.1130 = Newton Meters  
 Pound Feet x 1.3558 = Newton Meters

#### Metric to Metric

Newton Meters x 10.1972 = Kilogram Centimeters  
 Kilogram Centimeters x 0.0981 = Newton Meters  
 Newton Meters x 0.1020 = Kilogram Meters  
 Kilogram Meters x 9.8067 = Newton Meters

### Power Conversion Constants

#### Metric to U.S.

Kilowatt x 1.3410 = Horsepower  
 Watt x 0.0013 = Horsepower

#### U.S. to Metric

Horsepower x 745.6999 = Watt  
 Horsepower x 0.7457 = Kilowatt

### Velocity Conversion Constants

#### Metric to U.S.

Meters/Second x 196.8504 = Feet/Minute

#### U.S. to Metric

Feet/Minute x 0.0051 = Meters/Second

#### Metric to Metric

Meters/Second x 3.6000 = Kilometers/Hour

## Other Conversions

### Force Conversion Constants

#### Metric to U.S.

Newtons x 3.5969 = Ounces  
 Newtons x 0.2248 = Pounds  
 Kilograms x 2.2046 = Pounds

#### U.S. to Metric

Ounces x 0.2780 = Newtons  
 Pounds x 4.4482 = Newtons  
 Pounds x 0.4536 = Kilograms

#### Metric to Metric

Kilograms x 9.8067 = Newtons  
 Newtons x 0.1020 = Kilograms

### Length Conversion Constants

#### Metric to U.S.

Millimeters x 0.0394 = Inches  
 Meters x 39.3701 = Inches  
 Meters x 3.2808 = Feet  
 Meters x 1.0936 = Yards  
 Kilometers x 3280.84 = Feet  
 Kilometers x 0.6214 = Statute Miles  
 Kilometers x 0.5396 = Nautical Miles

#### U.S. to Metric

Inches x 25.4000 = Millimeters  
 Inches x 0.0254 = Meters  
 Feet x 0.3048 = Meters  
 Yards x 0.9144 = Meters  
 Feet x 0.0003048 = Kilometers  
 Statute Miles x 1.6093 = Kilometers  
 Nautical Miles x 1.8532 = Kilometers

### Area Conversion Constants

#### Metric to U.S.

Square Millimeters x 0.0016 = Square Inches  
 Square Centimeters x 0.1550 = Square Inches  
 Square Meters x 10.7639 = Square Feet  
 Square Meters x 1.1960 = Square Yards  
 Hectares x 2.4711 = Acres  
 Square Kilometers x 247.105 = Acres  
 Square Kilometers x 0.3861 = Square Miles

#### U.S. to Metric

Square Inches x 645.160 = Square Millimeters  
 Square Inches x 6.4516 = Square Centimeters  
 Square Feet x 0.0929 = Square Meters  
 Square Yards x 0.8361 = Square Meters  
 Acres x 0.4047 = Hectares  
 Acres x 0.004047 = Square Kilometers  
 Square Miles x 2.5900 = Square Kilometers

### Weight Conversion Constants

#### Metric to U.S.

Grams x 15.4324 = Grains  
 Grams x 0.0353 = Ounces (Avd.)  
 Grams x 0.0338 = Fluid Ounces (water)

Kilograms x 35.2740 = Ounces (Avd.)  
 Kilograms x 2.2046 = Pounds (Avd.)

Metric Tons (1000 Kg) x 1.1023 = Net Ton (2000 lb)  
 Metric Tons (1000 Kg) x 0.9842 = Gross Ton (2240 lb)

# Useful Formulas and Calculations

## Other Conversions – Continued

### Weight Conversion Constants – continued

#### U.S. to Metric

Grains	x 0.0648 = Grams	Pounds (Avd.)	x 0.4536 = Kilograms
Ounces (Avd.)	x 28.3495 = Grams	Net Ton (2000 lb)	x 0.9072 = Metric Tons (1000 Kg)
Fluid Ounces (water)	x 29.5735 = Grams	Gross Ton (2240 lb)	x 1.0160 = Metric Tons (1000 Kg)
Ounces (Avd.)	x 0.0283 = Kilograms		

### Measures of Pressure

1 pound per square inch	<ul style="list-style-type: none"> <li>= 144 pounds per square foot</li> <li>= 0.068 atmosphere</li> <li>= 2.042 inches of mercury at 62°F</li> <li>= 27.7 inches of water at 62°F</li> <li>= 2.31 feet of water at 62°F</li> </ul>	1 foot of water at 62°F	<ul style="list-style-type: none"> <li>= 62.35 pounds per square foot</li> <li>= 0.433 pounds per square inch</li> </ul>
1 atmosphere	<ul style="list-style-type: none"> <li>= 30 inches of mercury at 62°F</li> <li>= 14.7 pounds per square inch</li> <li>= 2116.3 pounds per square foot</li> <li>= 33.95 feet of water at 62°F</li> </ul>	1 inch of mercury at 62°F	<ul style="list-style-type: none"> <li>= 1.132 feet of water at 62°F</li> <li>= 13.58 inches of water</li> <li>= 0.491 pounds per square inch</li> </ul>

Column of water 12 inches high, 1 inch in diameter = 0.341 lb.

### Decimal and Millimeter Equivalents of Fractions

Inches			Inches		
Fractions	Decimals	Millimeters	Fractions	Decimals	Millimeters
1/64	.015625	.397	33/64	.515625	13.097
1/32	.03125	.794	17/32	.53125	13.494
3/64	.046875	1.191	35/64	.546875	13.891
1/16	.0625	1.588	9/16	.5625	14.288
5/64	.078125	1.984	37/64	.578125	14.684
3/32	.09375	2.381	19/32	.59375	15.081
7/64	.109375	2.778	39/64	.609375	15.478
1/8	.125	3.175	5/8	.625	15.875
9/64	.140625	3.572	41/64	.640625	16.272
5/32	.15625	3.969	21/32	.65625	16.669
11/64	.171875	4.366	43/64	.671875	17.066
3/16	.1875	4.763	11/16	.6875	17.463
13/64	.203125	5.159	45/64	.703125	17.859
7/32	.21875	5.556	23/32	.71875	18.256
15/64	.234375	5.953	47/64	.734375	18.653
1/4	.250	6.350	3/4	.750	19.050
17/64	.265625	6.747	49/64	.765625	19.447
9/32	.28125	7.144	25/32	.78125	19.844
19/64	.296875	7.541	51/64	.796875	20.241
5/16	.3125	7.938	13/16	.8125	20.638
21/64	.328125	8.334	53/64	.828125	21.034
11/32	.34375	8.731	27/32	.84375	21.431
23/64	.359375	9.128	55/64	.859375	21.828
3/8	.375	9.525	7/8	.875	22.225
25/64	.390625	9.922	57/64	.890625	22.622
13/32	.40625	10.319	29/32	.90625	23.019
27/64	.421875	10.716	59/64	.921875	23.416
7/16	.4375	11.113	15/16	.9375	23.813
29/64	.453125	11.509	61/64	.953125	24.209
15/32	.46875	11.906	31/32	.96875	24.606
31/64	.484375	12.303	63/64	.984375	25.003
1/2	.500	12.700	1	1.000	25.400



# Useful Formulas and Calculations

## Power To or From Machinery

In the absence of accurate data on horsepower requirements for a drive, it is sometimes possible to calculate the power output from a driveN machine or the required power input to a driveN machine. In each formula below, efficiency must be known or estimated. For checking a drive which is providing power to a pump or generator, it is more conservative to estimate a low efficiency for the driveN machine. For power input to a drive from a motor or turbine, it is more conservative to estimate high efficiency for the driveN machine. Efficiency is used as a decimal in the formulas. For example, if a pump is 70% efficient, use .70 in the formula.

### Hydraulic Machinery

#### Power required by pumps

$$\text{Horsepower} = \frac{(F) (P)}{(1714) (\text{eff})}$$

Where: F = Flow rate, gallons per minute

P = Discharge pressure for pumps, inlet pressure for turbines, pounds/square inch

eff = Overall mechanical and hydraulic efficiency.

#### Power from water wheel or turbine

$$\text{Horsepower} = \frac{(F) (P) (\text{eff})}{(1714)}$$

Where: F = Flow rate, gallons per minute

P = Discharge pressure for pumps, inlet pressure for turbines, pounds/square inch

eff = Overall mechanical and hydraulic efficiency.

### A.C. Machinery

$$\text{Kilowatts} = \frac{(\text{volts}) (\text{amps}) (\text{p.f.})}{Y}$$

Where: p.f. = Power factor

Y = 1000 (Single phase)

Y = 577 (Three phase)

#### Power required for generator (alternator)

$$\text{Horsepower} = \frac{(\text{volts}) (\text{amps}) (\text{p.f.})}{(Z) (\text{eff})}$$

Where: eff = Overall mechanical and hydraulic efficiency.

p.f. = Power factor

Z = 746 (Single phase)

Z = 431 (Three phase)

#### Power from motor

$$\text{Horsepower} = \frac{(\text{volts}) (\text{amps}) (\text{p.f.}) (\text{EFF})}{(Z)}$$

Where: eff = Overall mechanical and hydraulic efficiency.

p.f. = Power factor

Z = 746 (Single phase)

Z = 431 (Three phase)

### D.C. Machinery

$$\text{Kilowatts} = \frac{(\text{volts}) (\text{amps})}{1000}$$

#### Power required for generator

$$\text{Horsepower} = \frac{(\text{volts}) (\text{amps})}{(746)(\text{eff})}$$

Where: eff = Overall mechanical and hydraulic efficiency.

#### Power from motor

$$\text{Horsepower} = \frac{(\text{volts}) (\text{amps}) (\text{eff})}{746}$$

Where: eff = Overall mechanical and hydraulic efficiency.

# Gates Application Data Worksheet

Company: \_\_\_\_\_ Contact: \_\_\_\_\_  
Address: \_\_\_\_\_ Title: \_\_\_\_\_  
\_\_\_\_\_  
Phone: \_\_\_\_\_ Fax: \_\_\_\_\_  
\_\_\_\_\_  
Email: \_\_\_\_\_

## Application Summary

General Description: \_\_\_\_\_  
Product Type: \_\_\_\_\_ Estimated Production Volume: \_\_\_\_\_  
Prototype Time Schedule: \_\_\_\_\_ Production Time Schedule: \_\_\_\_\_  
Function:  Motion Transfer  Reversing  Light Loads  Moderate Loads  Heavy Loads  
 On/Off Cycle  Continuous Operation Cycle Description: \_\_\_\_\_

## Design Parameters

### DriveR

Motor Type & Description (Servo, Stepper, D.C., A.C., etc.): \_\_\_\_\_  
Nominal Motor Torque/Power Output: \_\_\_\_\_ RPM: \_\_\_\_\_  
Max/Peak Motor Torque/Power Output: \_\_\_\_\_ RPM: \_\_\_\_\_  
Motor Stall Torque (If Applicable): \_\_\_\_\_

### DriveN

Description of DriveN Component: \_\_\_\_\_  
Required Operating RPM: \_\_\_\_\_ Speed Ratio: \_\_\_\_\_ Speed Up/Down: \_\_\_\_\_  
Additional Details: \_\_\_\_\_

## Geometry

Two Point Drive  Multi-Point Drive If Multi-Point: Are Layout Prints Available?  Yes  No  
Center Distance Range: \_\_\_\_\_ To \_\_\_\_\_  Fixed Design  Adjustable Design  
Type of Adjustment: \_\_\_\_\_  
Tensioner Idler:  None  Inside  Outside  Slack Side  Tight Side  Diameter: \_\_\_\_\_  
**DriveR:** Max O.D. \_\_\_\_\_ Max Width \_\_\_\_\_ **DriveN:** Max O.D. \_\_\_\_\_ Max Width \_\_\_\_\_

## Special Requirements

Product Design Life: \_\_\_\_\_ Belt Design Life: \_\_\_\_\_ Usage: Hours/Day: \_\_\_\_\_ Hours/Year: \_\_\_\_\_  
Shafts: DriveR \_\_\_\_\_ DriveN \_\_\_\_\_ Pulley Materials: Prototype \_\_\_\_\_ Production \_\_\_\_\_  
Environmental Conditions:  
Temperature \_\_\_\_\_ Moisture \_\_\_\_\_ Oil \_\_\_\_\_ Abrasives \_\_\_\_\_ Static Conductivity \_\_\_\_\_  
Special Requirements (Registration, Motion Control, Speed Control, Etc.) \_\_\_\_\_





**POWERING PROGRESS™**

---

**GATES CORPORATION**  
800.777.6363  
[Gates.com/DriveDesign](http://Gates.com/DriveDesign)

For Power Transmission drive design assistance,  
contact Gates Product Application at **303-744-5080**  
or [ptpasupport@gates.com](mailto:ptpasupport@gates.com).

©2015 Gates Corporation  
17183 1/2015